

Hydraulic Coverage Chart – BLADELESS (K) IMPELLERS

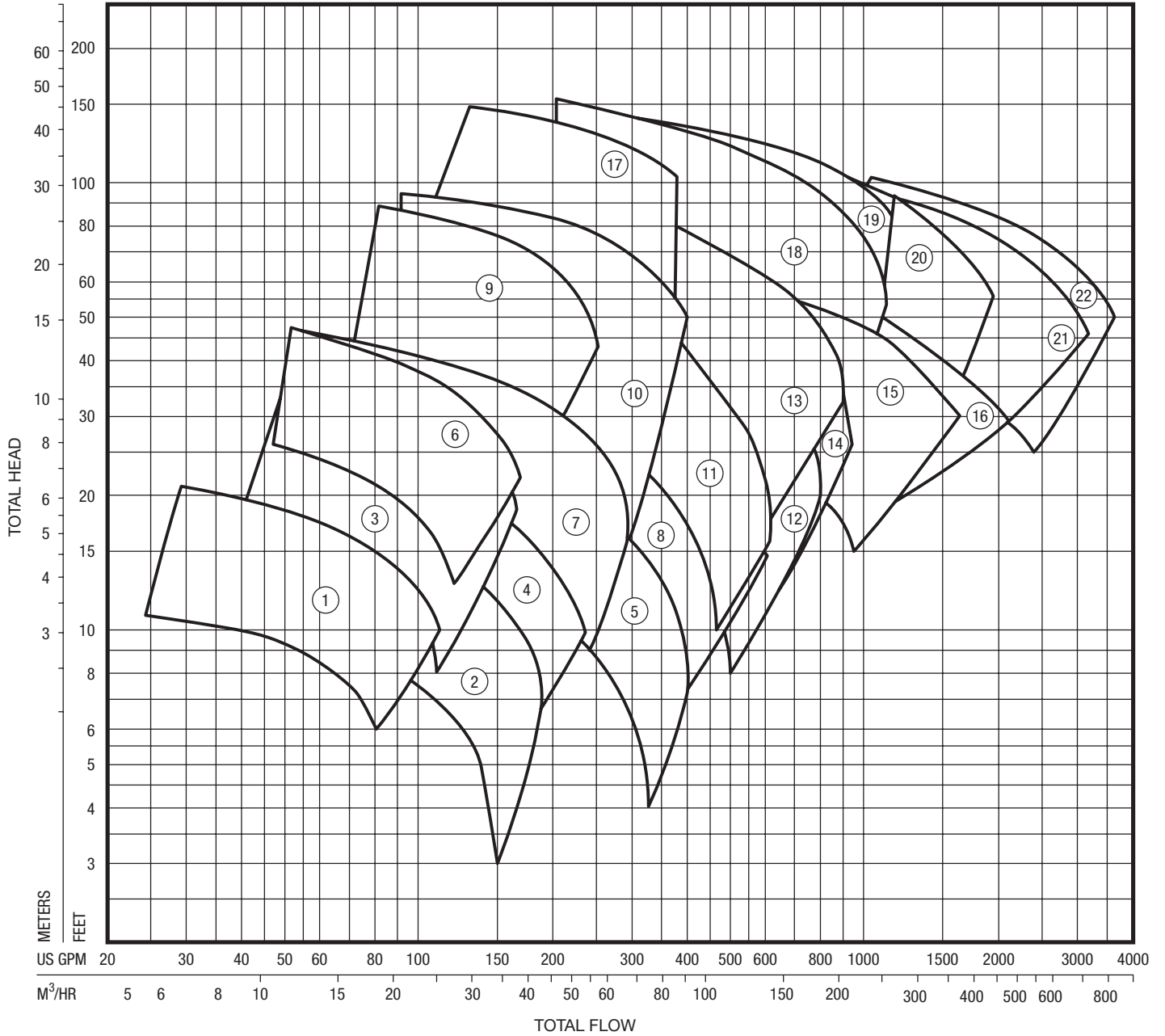

No.	Pump	RPM
1	2" 5431K	1150
2	3" 5431K	1150
3	2" 5432K	1165
4	3" 5432K	1165
5	4" 5431K	1165
6	2" 5431K	1750
7	3" 5431K	1750
8	4" 5432K	1165

No.	Pump	RPM
9	2" 5432K	1750
10	3" 5432K	1760
11	4" 5431K	1750
12	4" 5433K	1170
13	4" 5432K	1760
14	5" 5433K	1170
15	6" 5434K	875
16	8" 5434K	875

No.	Pump	RPM
17	3" 5433K	1765
18	4" 5433K	1770
19	5" 5433K	1775
20	6" 5434K	1170
21	8" 5434K	1170
22	10" 5435K	875

Hydraulic Coverage Chart – 2-3 VANE IMPELLERS

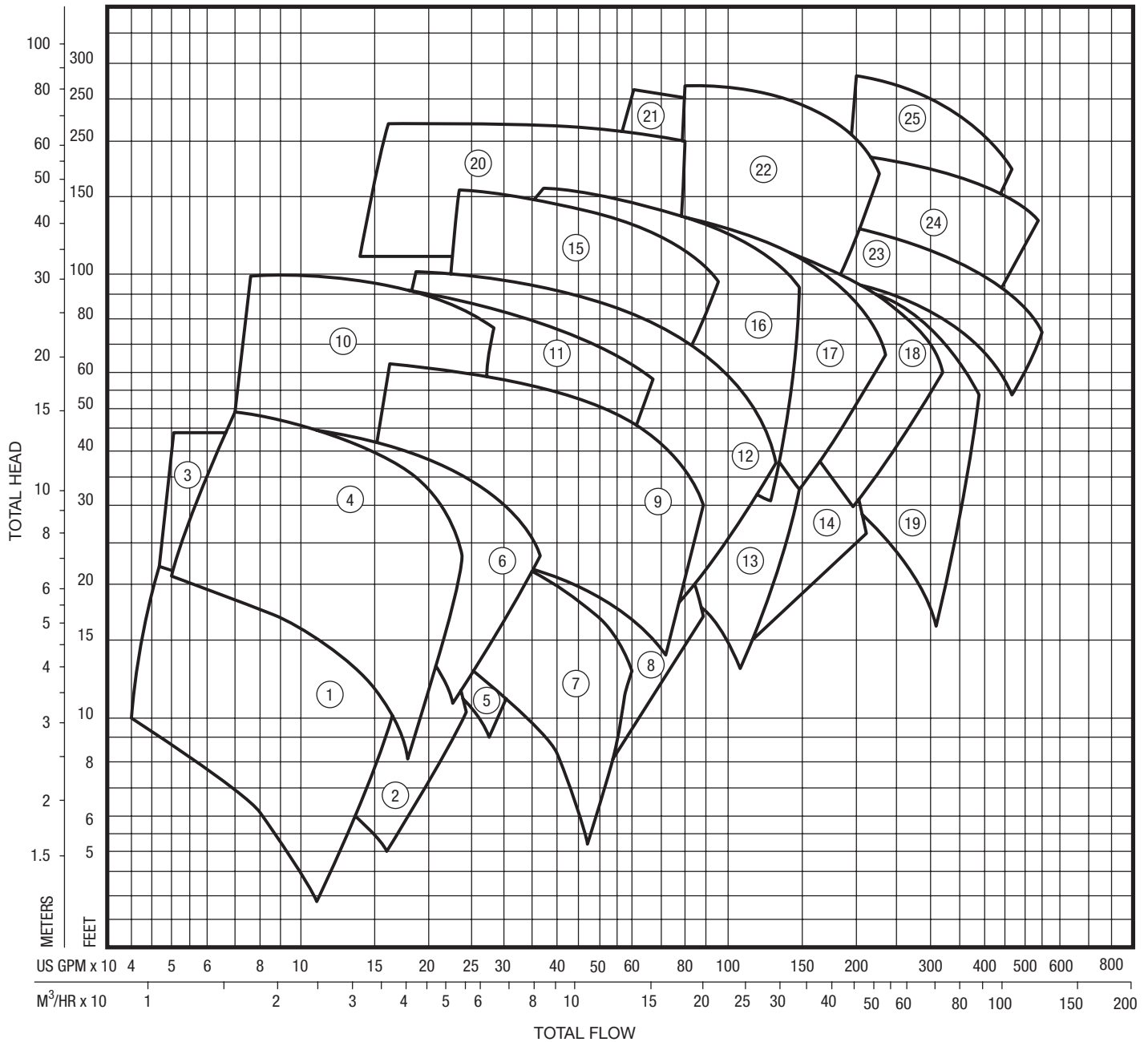

No.	Pump	RPM
1	2" 5431	1150
2	3" 5431	1165
3	2" 5432	1165
4	2" 5431	1750
5	3" 5432	1165
6	3" 5431	1750
7	4" 5431	1165
8	4" 5432	1170
9	4" 5431	1760

No.	Pump	RPM
10	2" 5432	1760
11	3" 5432	1760
12	4" 5432	1765
13	5" 5433	1180
14	6" 5433	1180
15	3" 5433	1775
16	4" 5433	1775
17	5" 5433	1780
18	6" 5433	1780

No.	Pump	RPM
19	8" 5434	1185
20	4" 5435	1780
21	5" 5436	1785
22	4" 5434	1785
23	8" 5435	1185
24	8" 5436	1185
25	6" 5436	1785

Hydraulic Coverage Chart – 2-3 VANE IMPELLERS

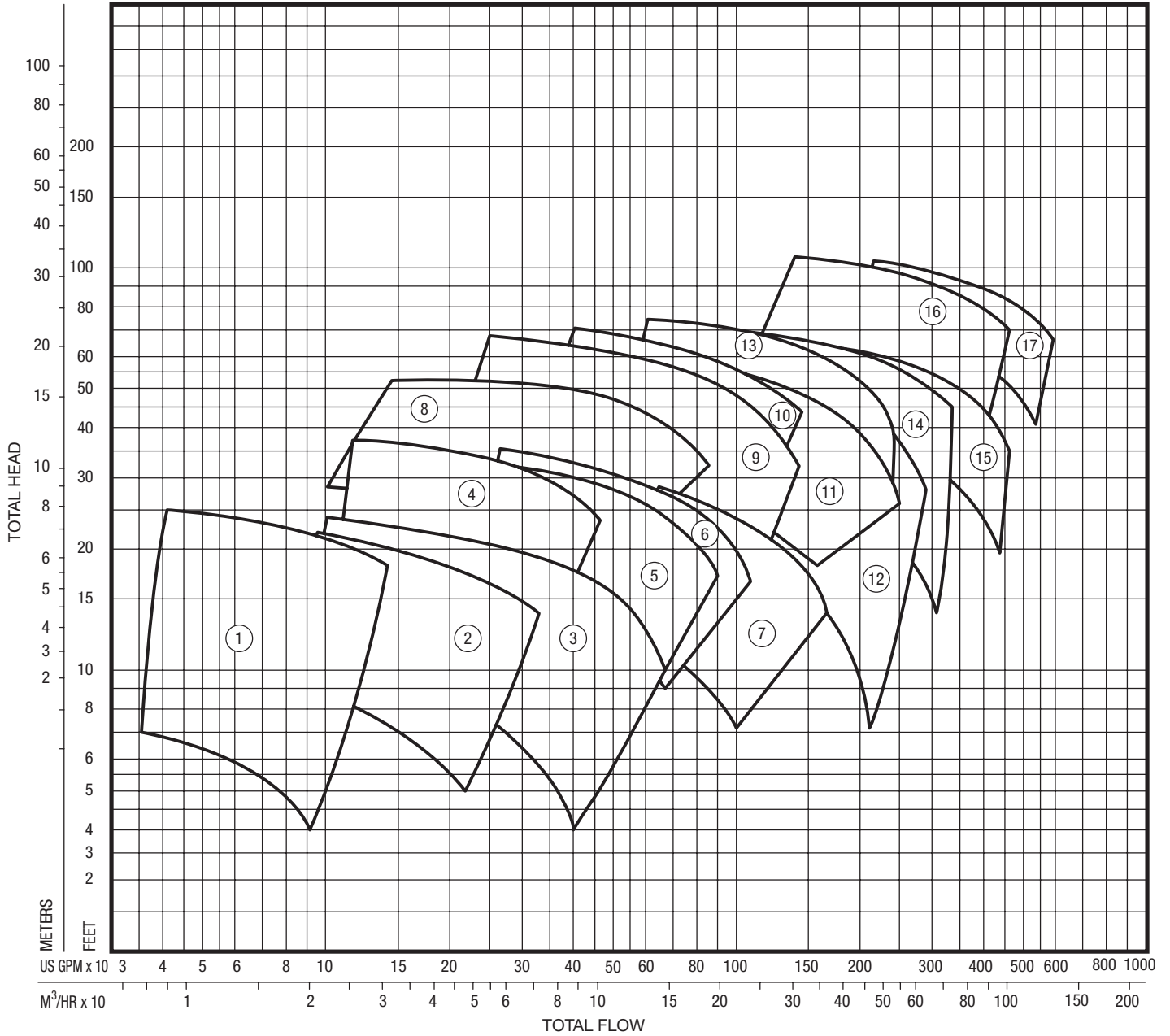

No.	Pump	RPM
1	2" 5432	870
2	3" 5432	870
3	4" 5432	870
4	3" 5433	875
5	4" 5433	875
6	5" 5433	875
7	6" 5433	875
8	4" 5435	870
9	4" 5434	880

No.	Pump	RPM
10	5" 5434	880
11	6" 5434	880
12	8" 5434	880
13	6" 5436	885
14	8" 5435	705
15	10" 5435	705
16	8" 5435	885
17	10" 5435	890

Performance Curve – 2" 5431 MTK, WK, WDK

RPM: 1735 SOLIDS: 1-1/2"

IMPELLER: T2A1X, BLADELESS SUCTION: 2" INLET: 6.51 in²

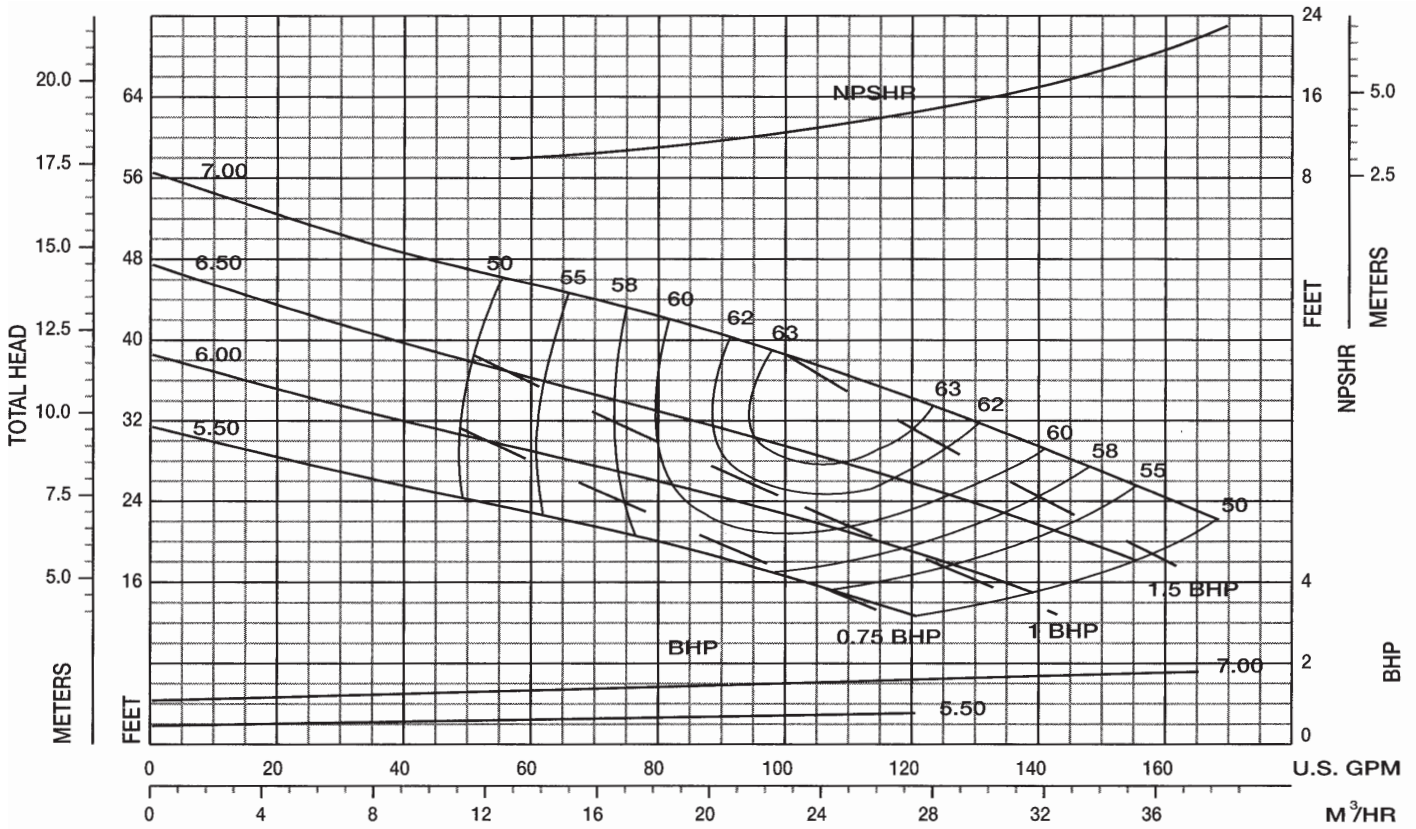

Performance Curve – 2" 5431 MT, W, WD

RPM: 1725 SOLIDS: 1-1/2"

IMPELLER: T2A1A, 2 VANE SUCTION: 2" INLET: 9.28 in²

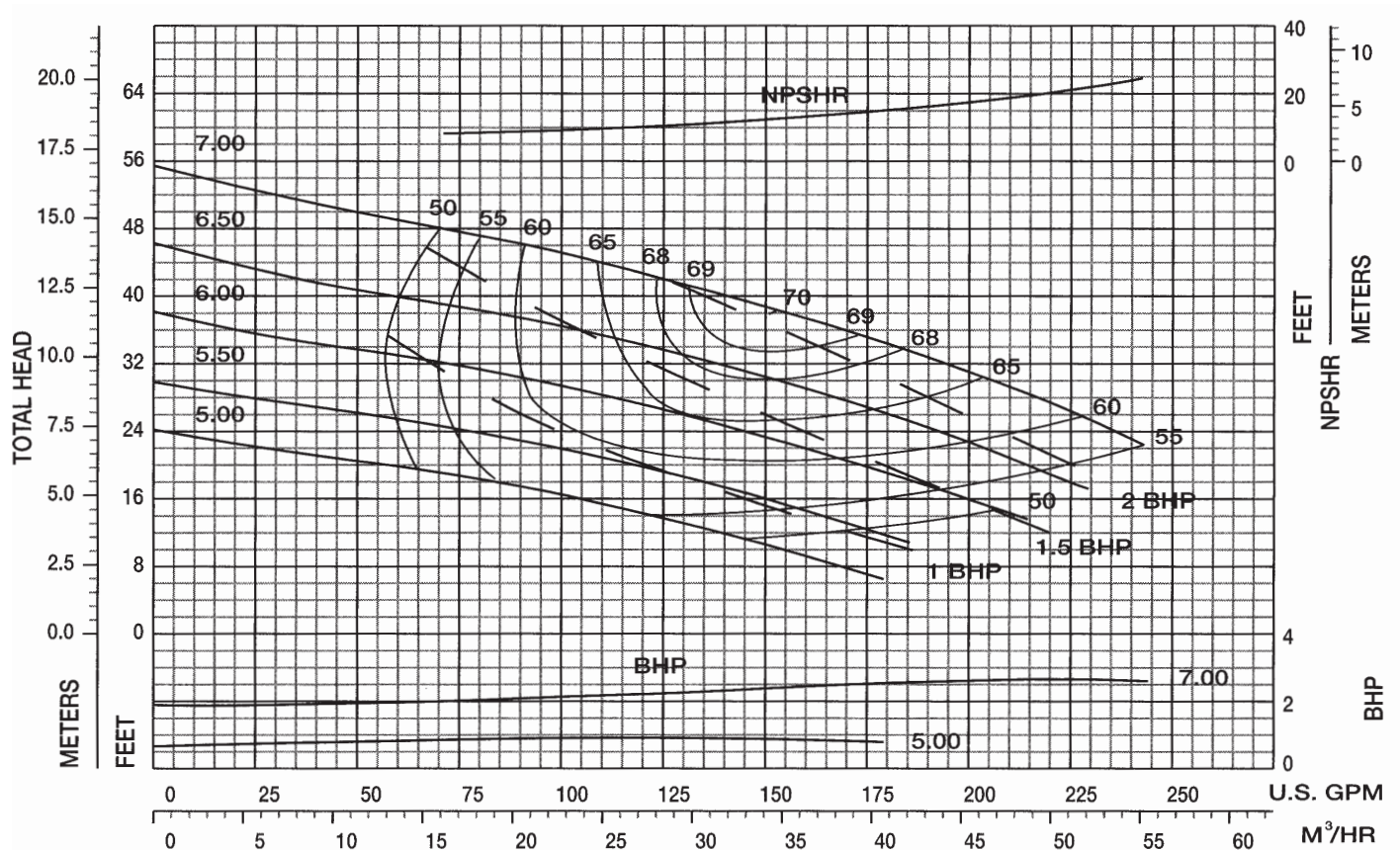

Performance Curve – 3" 5431 MTK, WK, WDK

RPM: 1725 SOLIDS: 2"

IMPELLER: T3A1X, BLADELESS SUCTION: 3" (WDK: 3" or 4") INLET: 11.41 in²

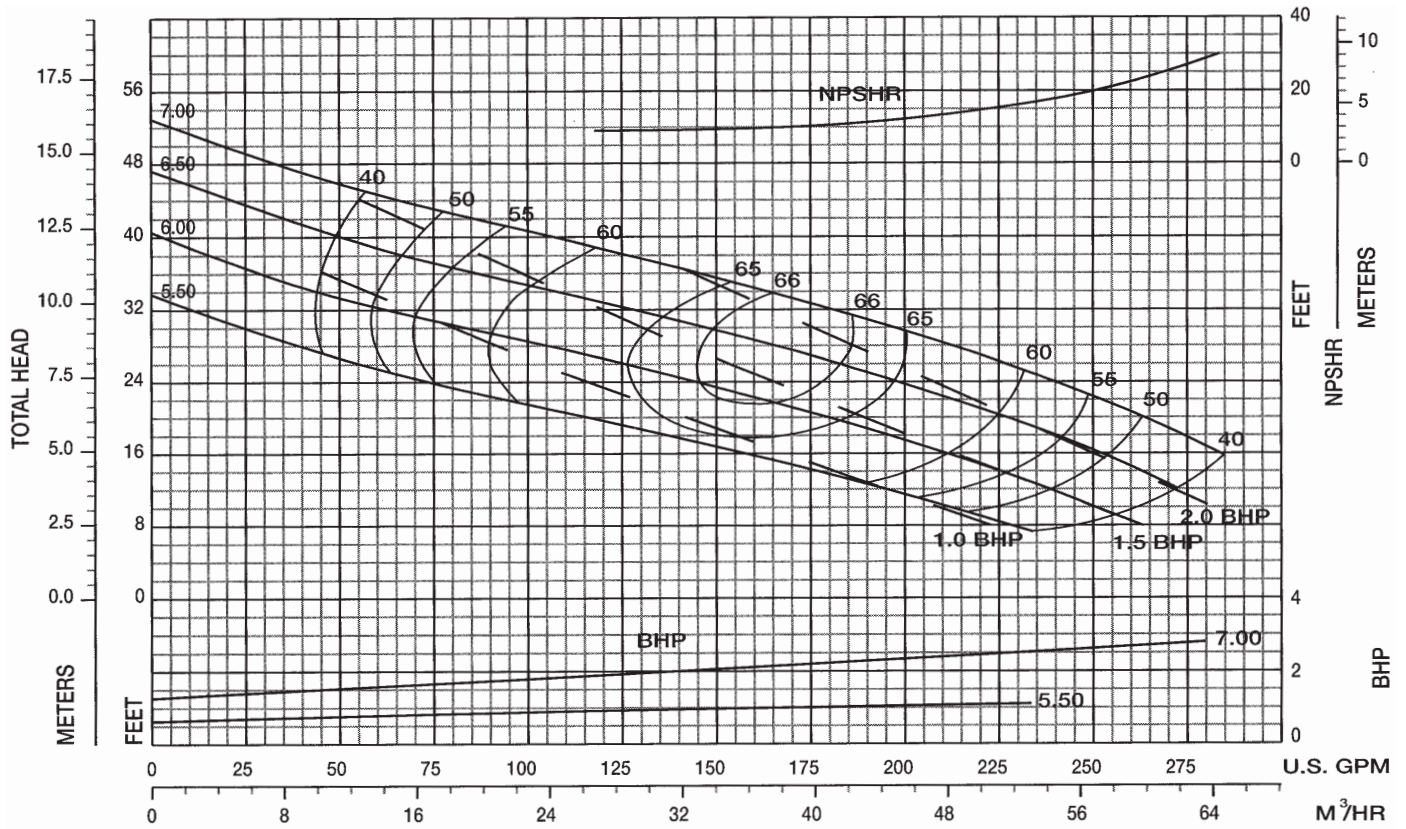

Performance Curve – 3" 5431 MT, W, WD

RPM: 1735 SOLIDS: 2"

IMPELLER: T3A1A, 2 VANE SUCTION: 3" (WD: 3" or 4") INLET: 13.20 in²

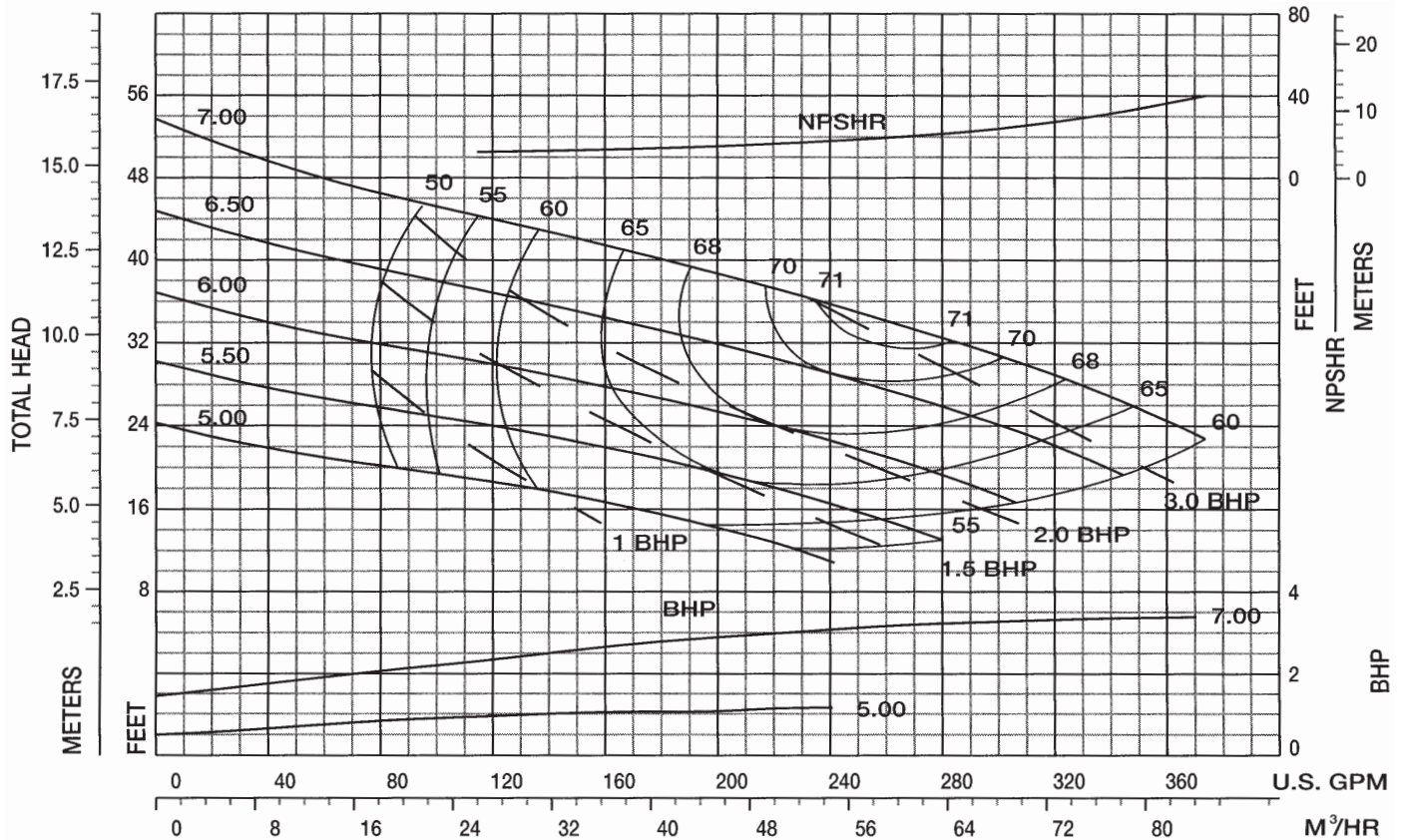

Performance Curve – 4" 5431 MTK, WK, WDK, CWDK

RPM: 1735 SOLIDS: 2-1/2"

IMPELLER: T4A1C, BLADELESS SUCTION: 4" (WDK: 4" or 6") INLET: 20.57 in²

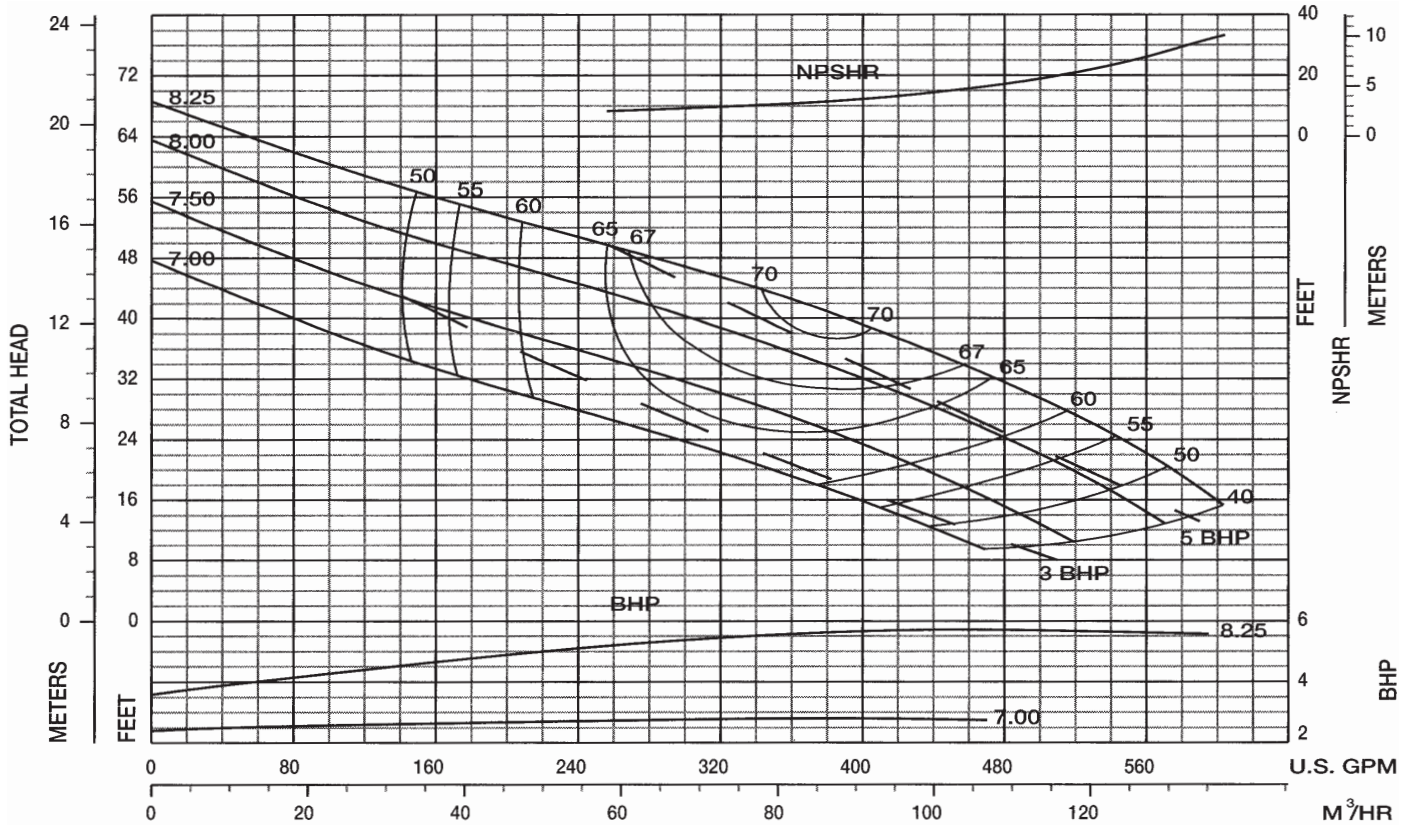

Performance Curve – 4" 5431 MT, W, WD, CWD

RPM: 1755 SOLIDS: 2-1/2"

IMPELLER: T4A1A, 2 VANE SUCTION: 4" (WD: 4" or 6") INLET: 23.49 in²

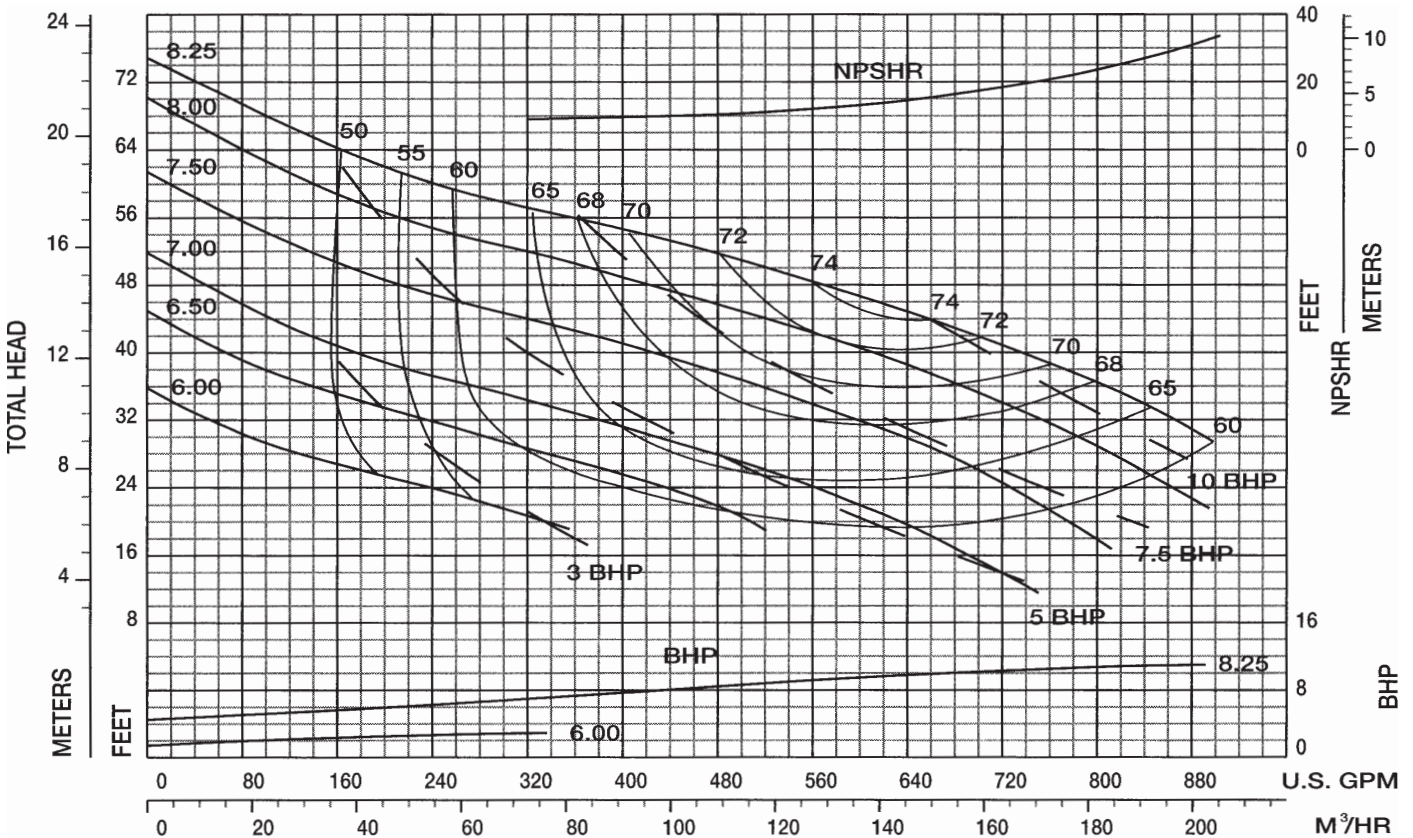

Performance Curve – 2" 5432 MTK, WK, WDK

RPM: 1740 SOLIDS: 1-1/2"

IMPELLER: T2B1AE, BLADELESS SUCTION: 2" INLET: 5.09 in²

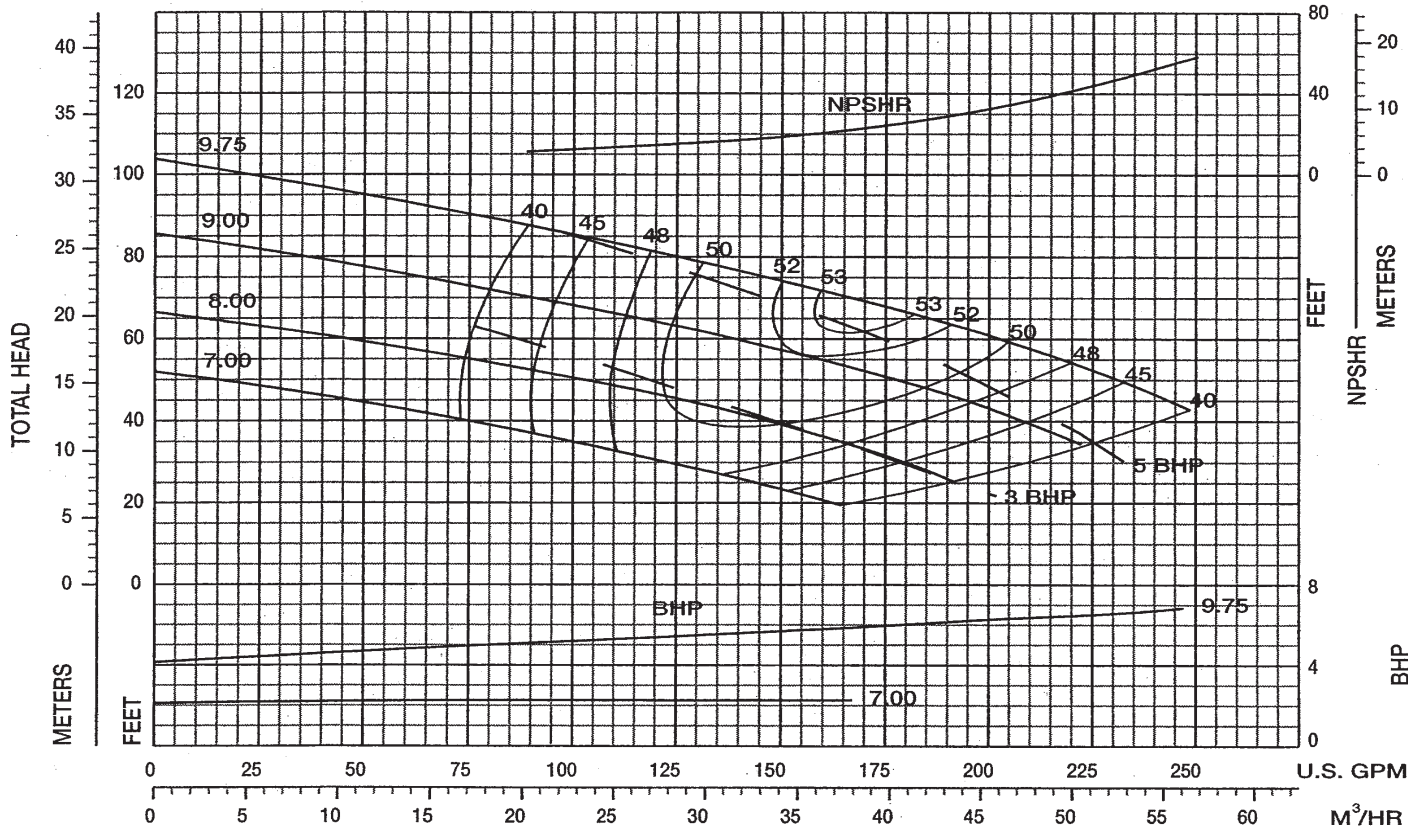

Performance Curve – 2" 5432 MT, W, WD

RPM: 1755 SOLIDS: 1-1/2"

IMPELLER: T2B1A, 2 VANE SUCTION: 2" INLET: 14.91 in²

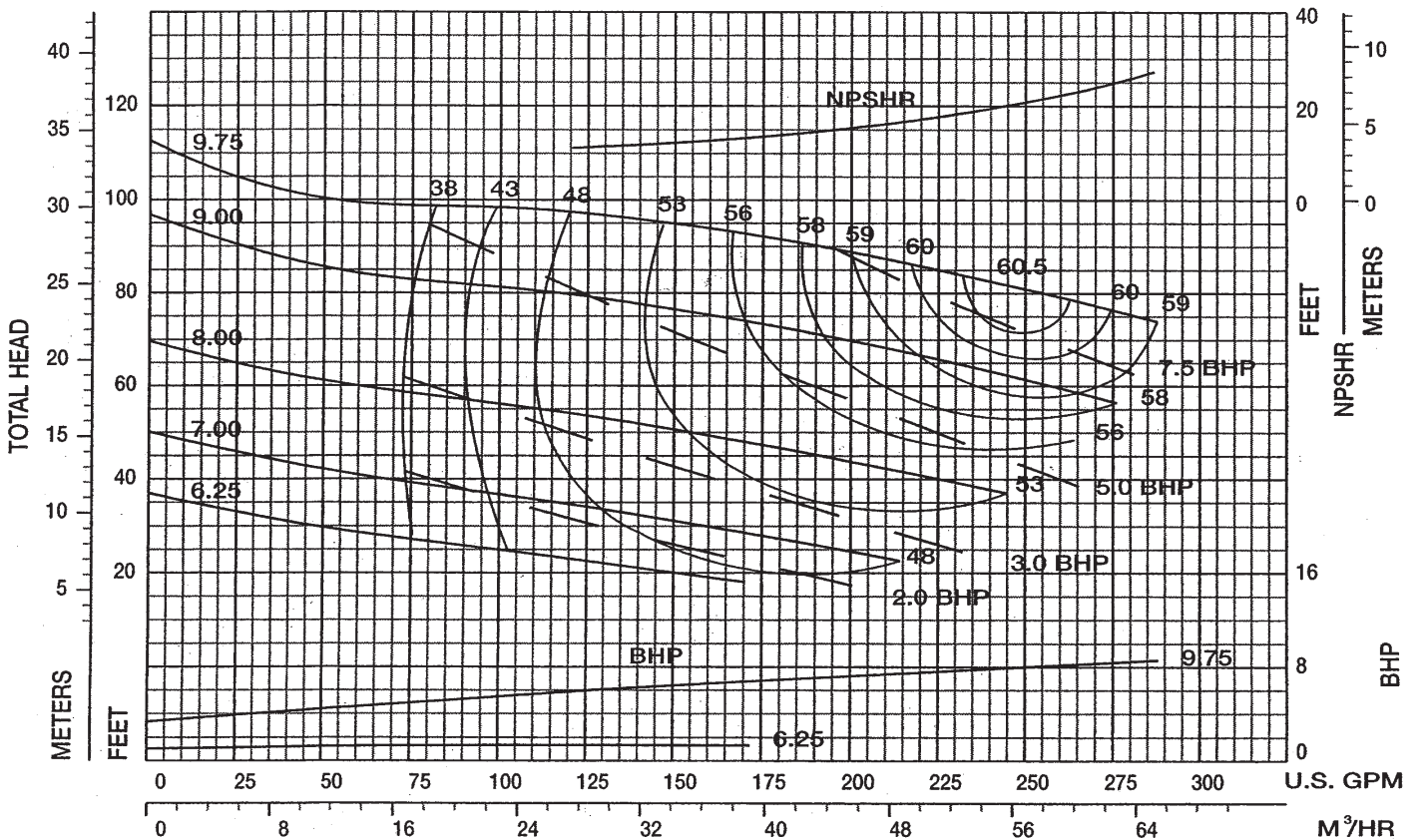

Performance Curve – 3" 5432 MTK, MVK, WK, WDK

RPM: 1740 SOLIDS: 2"

IMPELLER: T3B1AH, BLADELESS SUCTION: 3" (WDK: 3" or 4") INLET: 11.46 in²

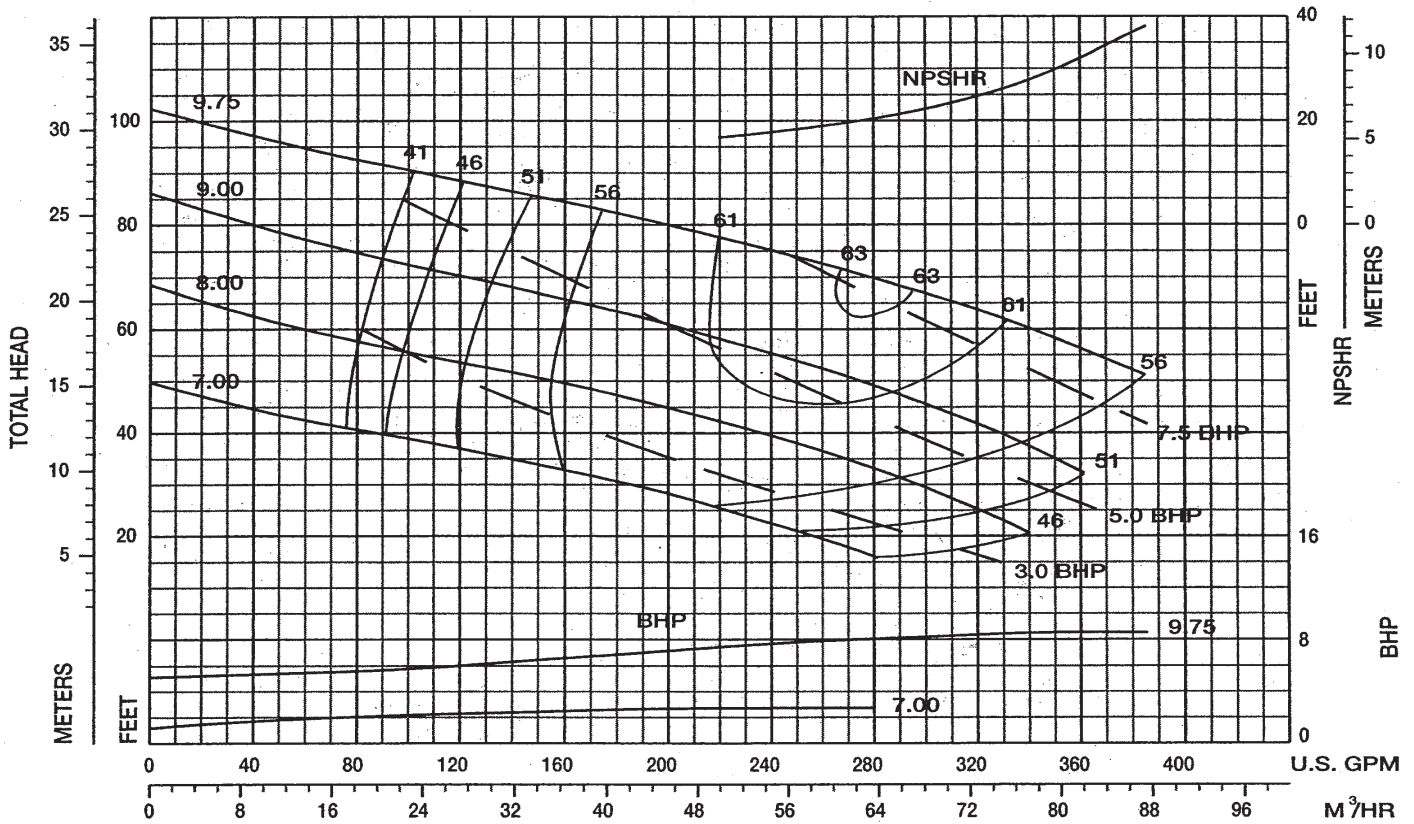

Performance Curve – 3" 5432 MT, MV, W, WD

RPM: 1750 SOLIDS: 2"

IMPELLER: T3B1A, 2 VANE SUCTION: 3" (WD: 3" or 4") INLET: 20.39 in²

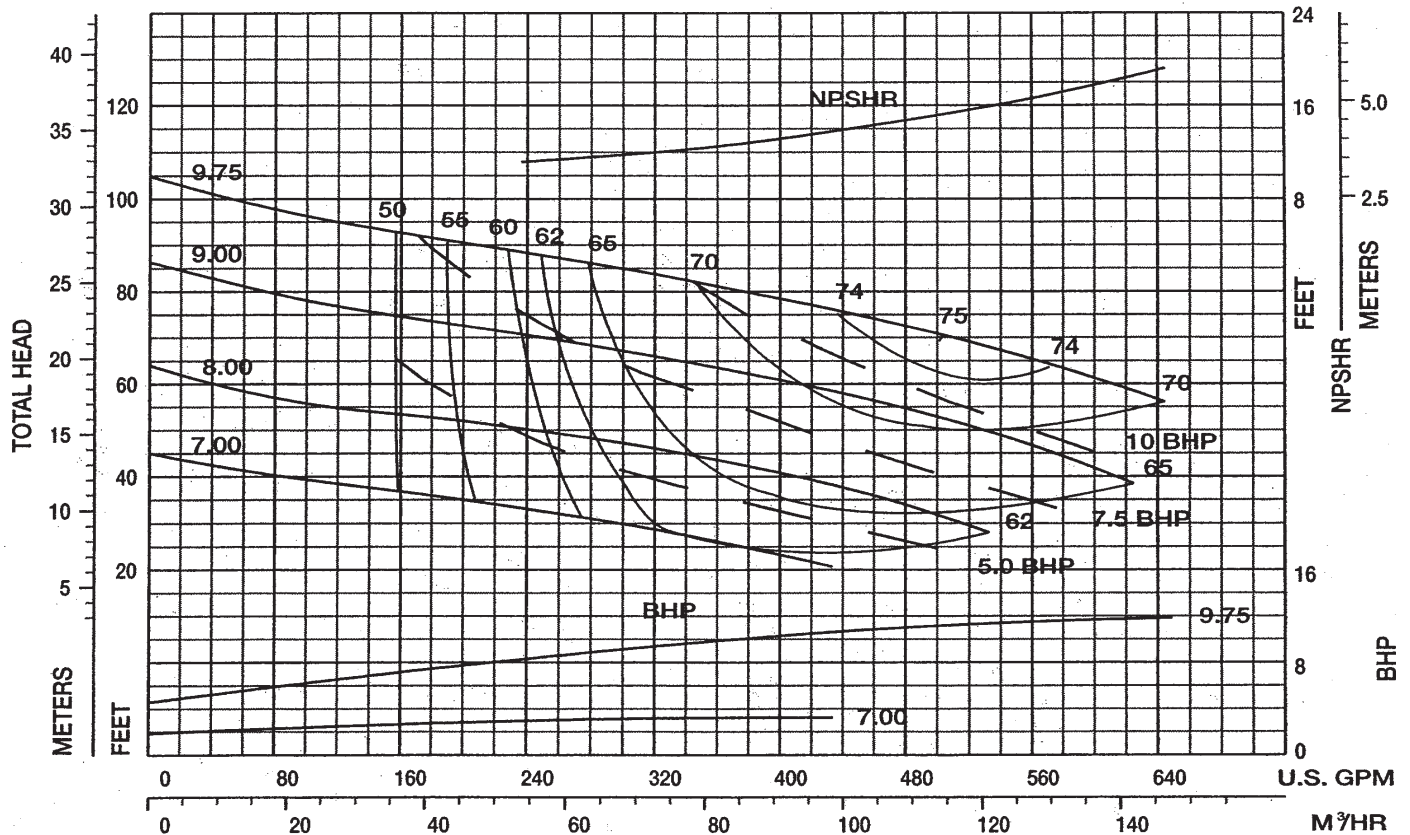

Performance Curve – 4" 5432 MTK, WK, WDK, CWDK

RPM: 1750 SOLIDS: 3"

IMPELLER: T4B1AF, BLADELESS SUCTION: 4" (WDK: 4" or 6") INLET: 26.72 in²

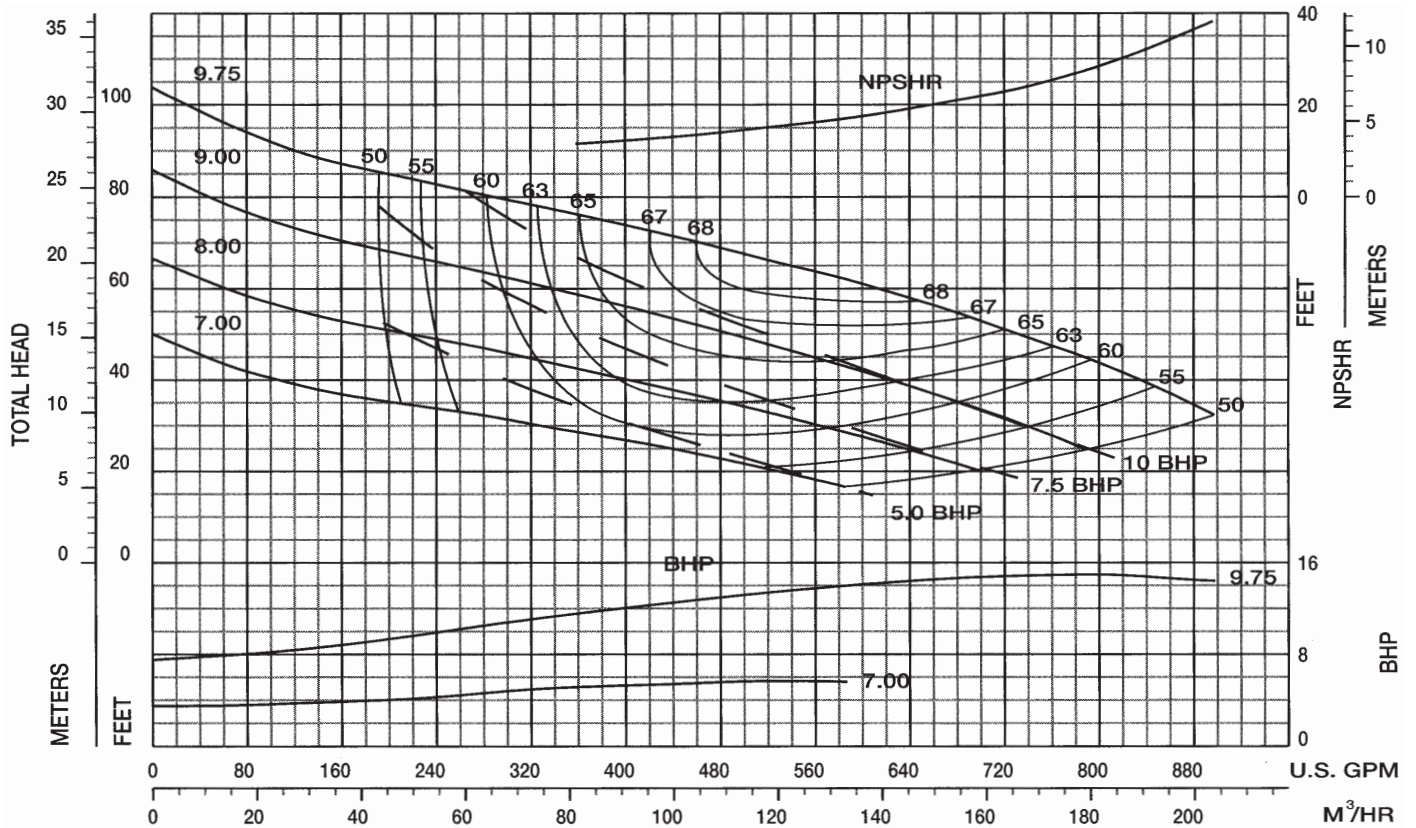

Performance Curve – 4" 5432 MT, W, WD, CWD

RPM: 1765 SOLIDS: 3"

IMPELLER: T4B1A, 2 VANE SUCTION: 4" (WD: 4" or 6") INLET: 26.22 in²

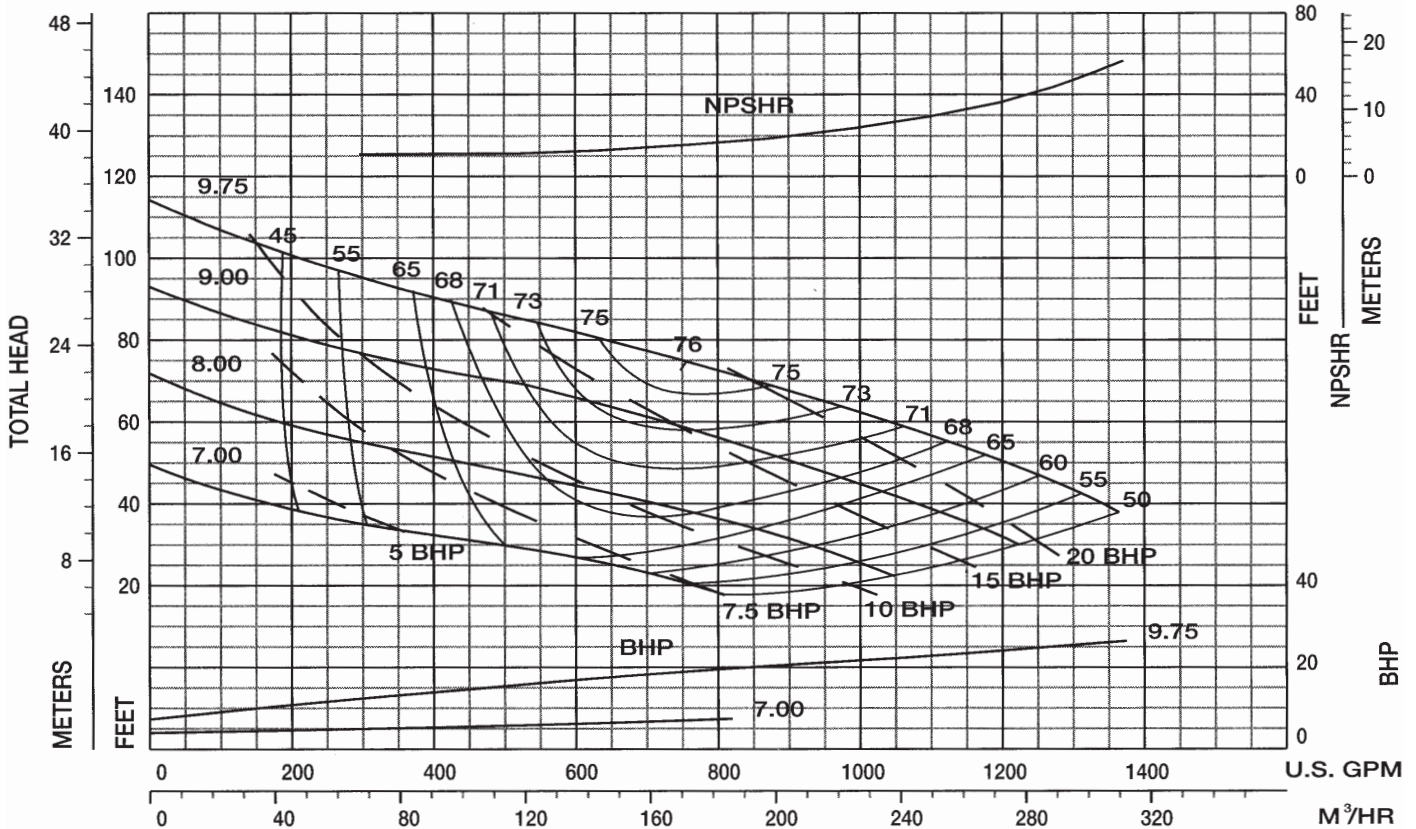

Performance Curve - 4" 5432 MVK

RPM: 1750 SOLIDS: 3"

IMPELLER: T4B1AF, BLADELESS SUCTION: 4" INLET: 26.72 in²

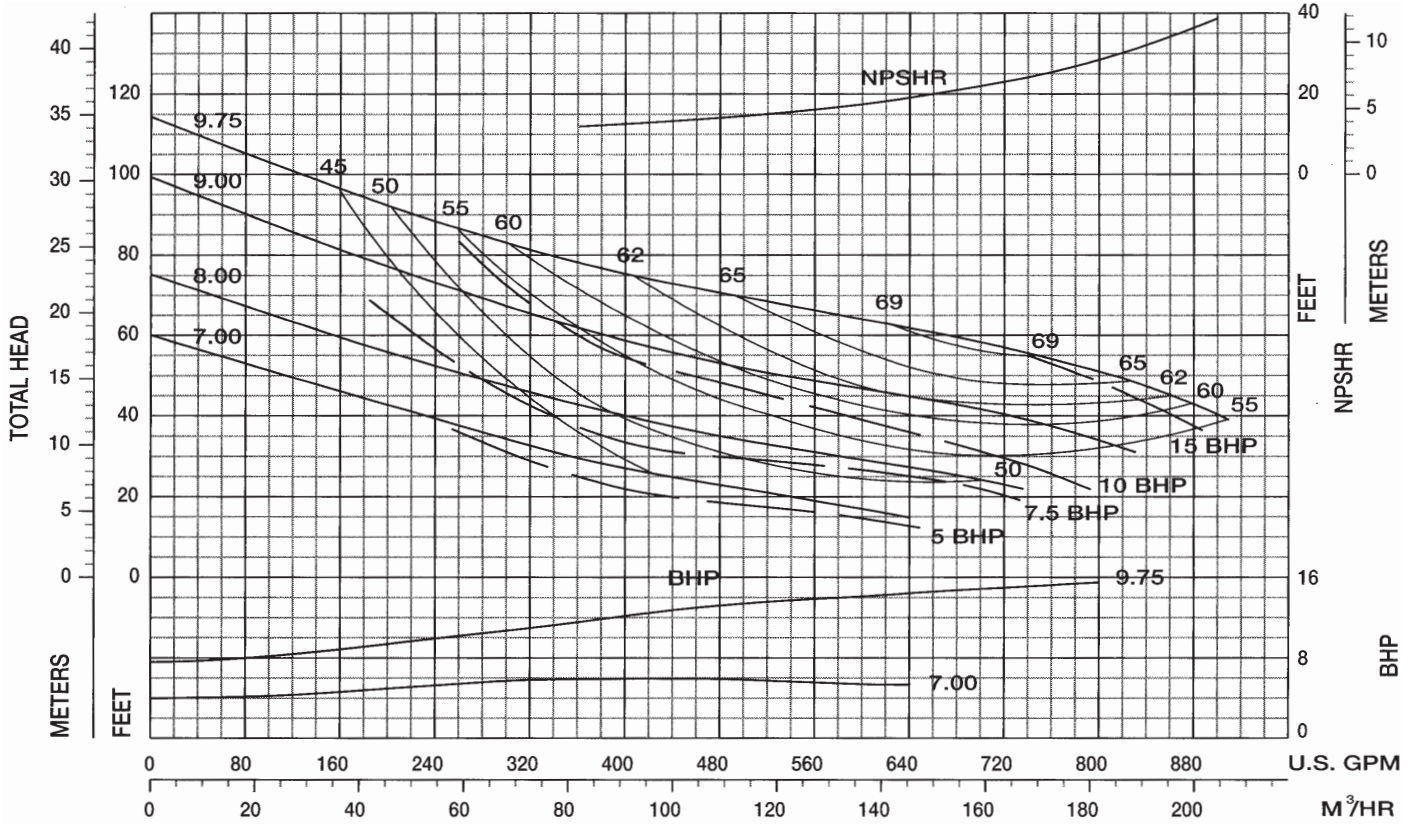

Performance Curve - 4" 5432 MV

RPM: 1765 SOLIDS: 3"

IMPELLER: T4B1A, 2 VANE SUCTION: 4" INLET: 26.22 in²

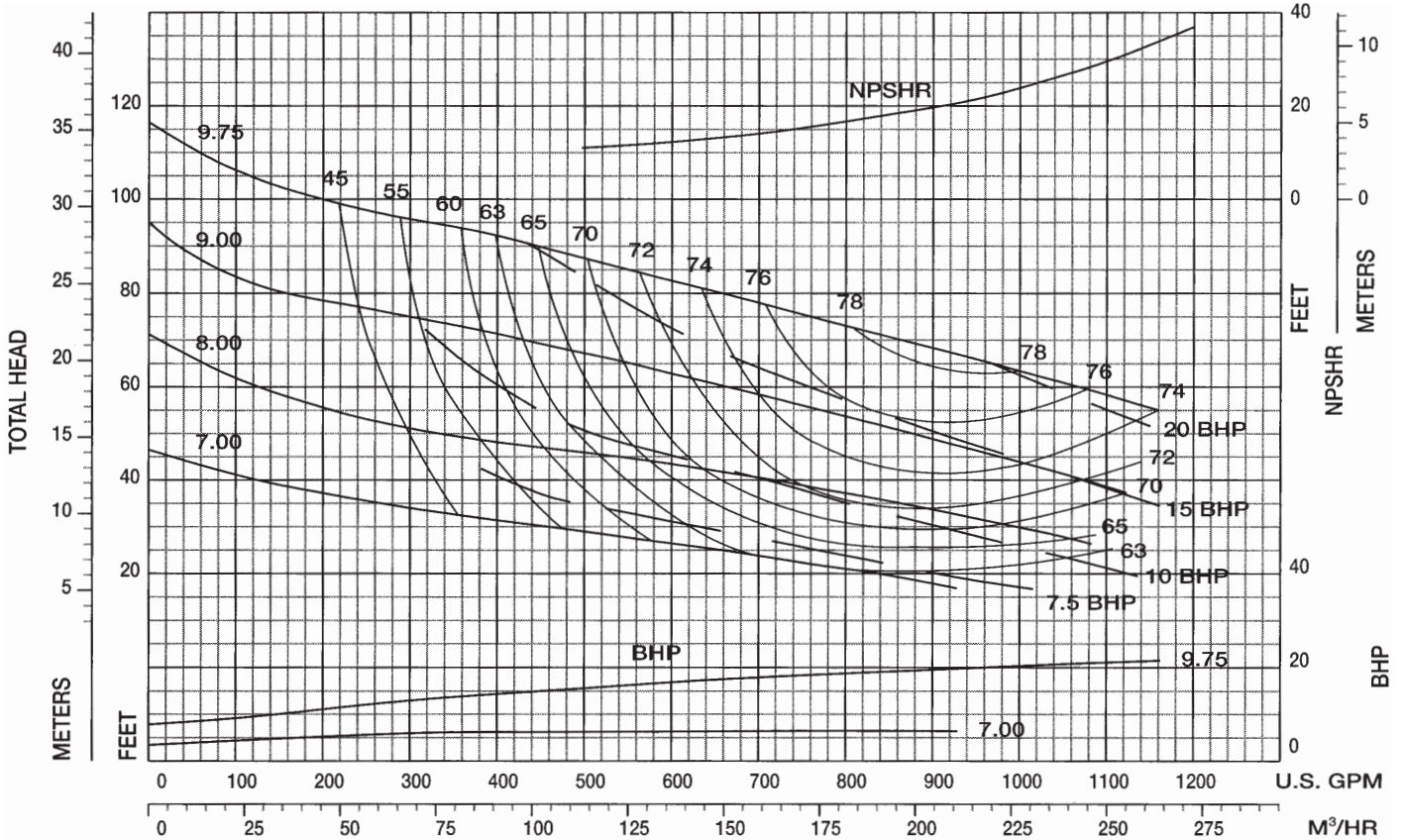

Performance Curve - 3" 5433 MTK, MVK, WK, WDK

RPM: 1750 SOLIDS: 2"

IMPELLER: T3C1T, BLADELESS SUCTION: 3" (WDK: 3" or 4") INLET: 11.77 in²

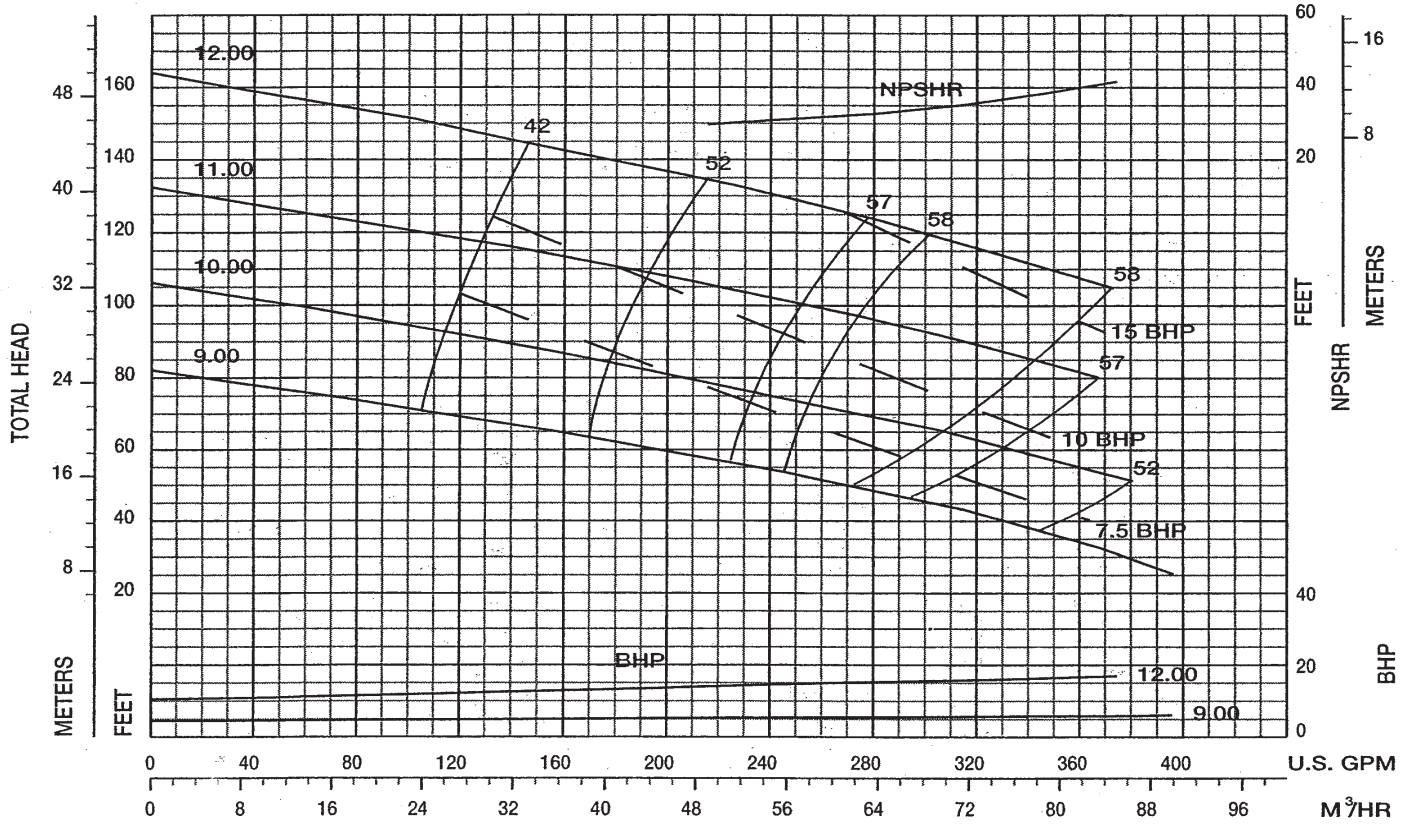

Performance Curve - 3" 5433 MT, MV, W, WD

RPM: 1760 SOLIDS: 2"

IMPELLER: T3C1A, 2 VANE SUCTION: 3" (WD: 3" or 4") INLET: 23.52 in²

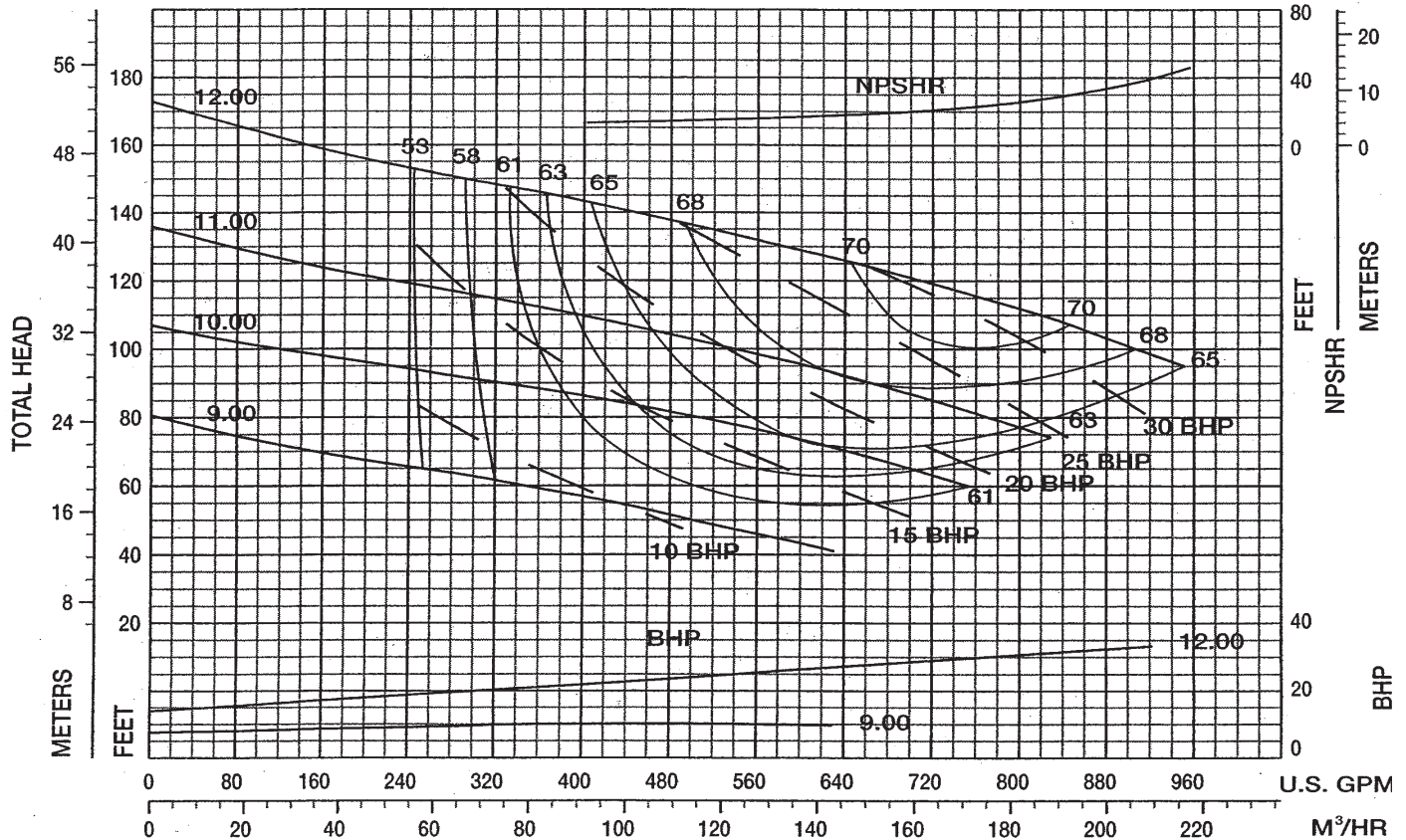

Performance Curve - 4" 5433 MTK, WK, WDK, CWDK

RPM: 1770 SOLIDS: 3"

IMPELLER: T4C1AA, BLADELESS SUCTION: 4" (WDK: 4" or 6") INLET: 23.77 in²

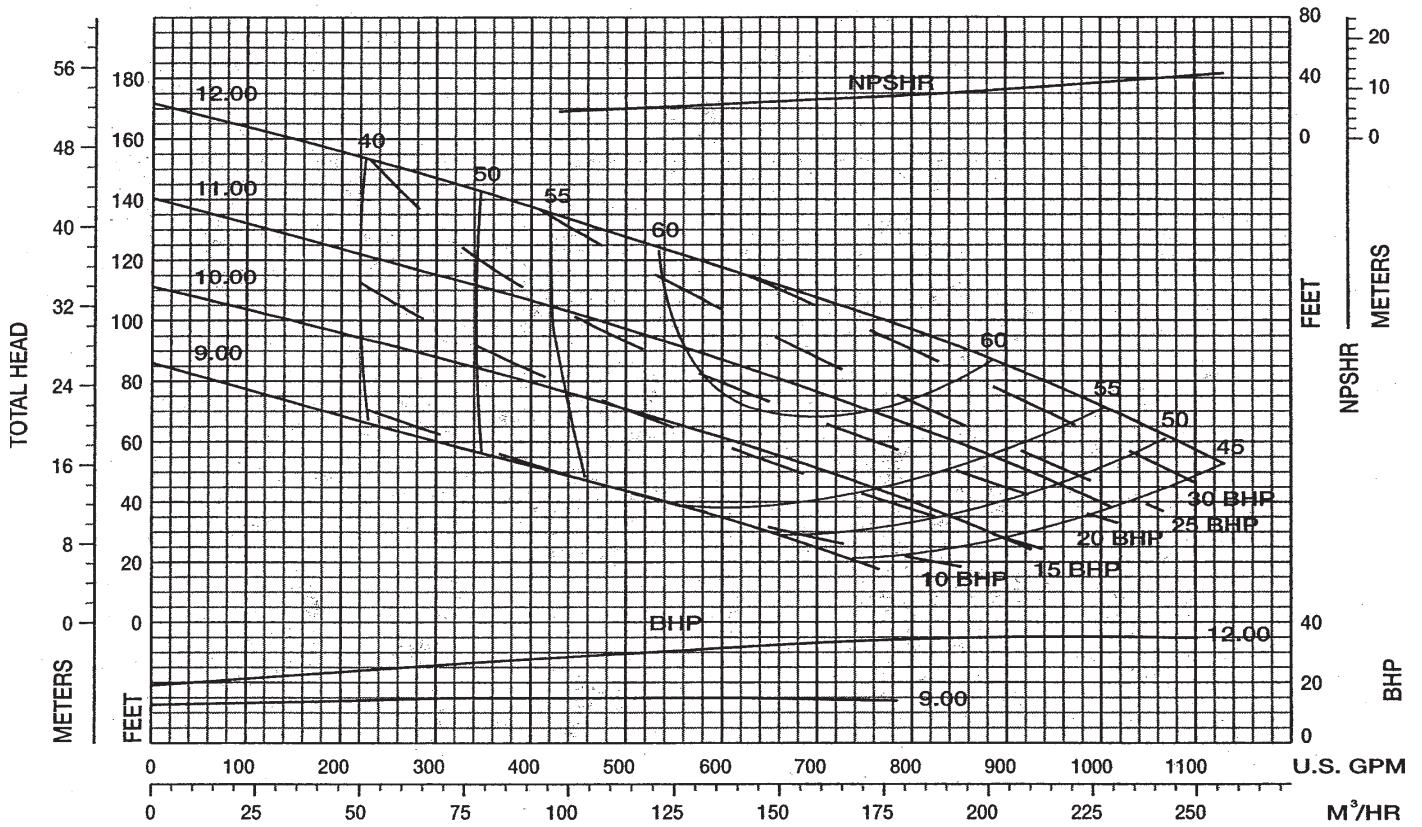

Performance Curve - 4" 5433 MT, W, WD, CWD

RPM: 1770 SOLIDS: 3"

IMPELLER: T4C1A, 2 VANE SUCTION: 4" (WD: 4" or 6") INLET: 37.50 in²

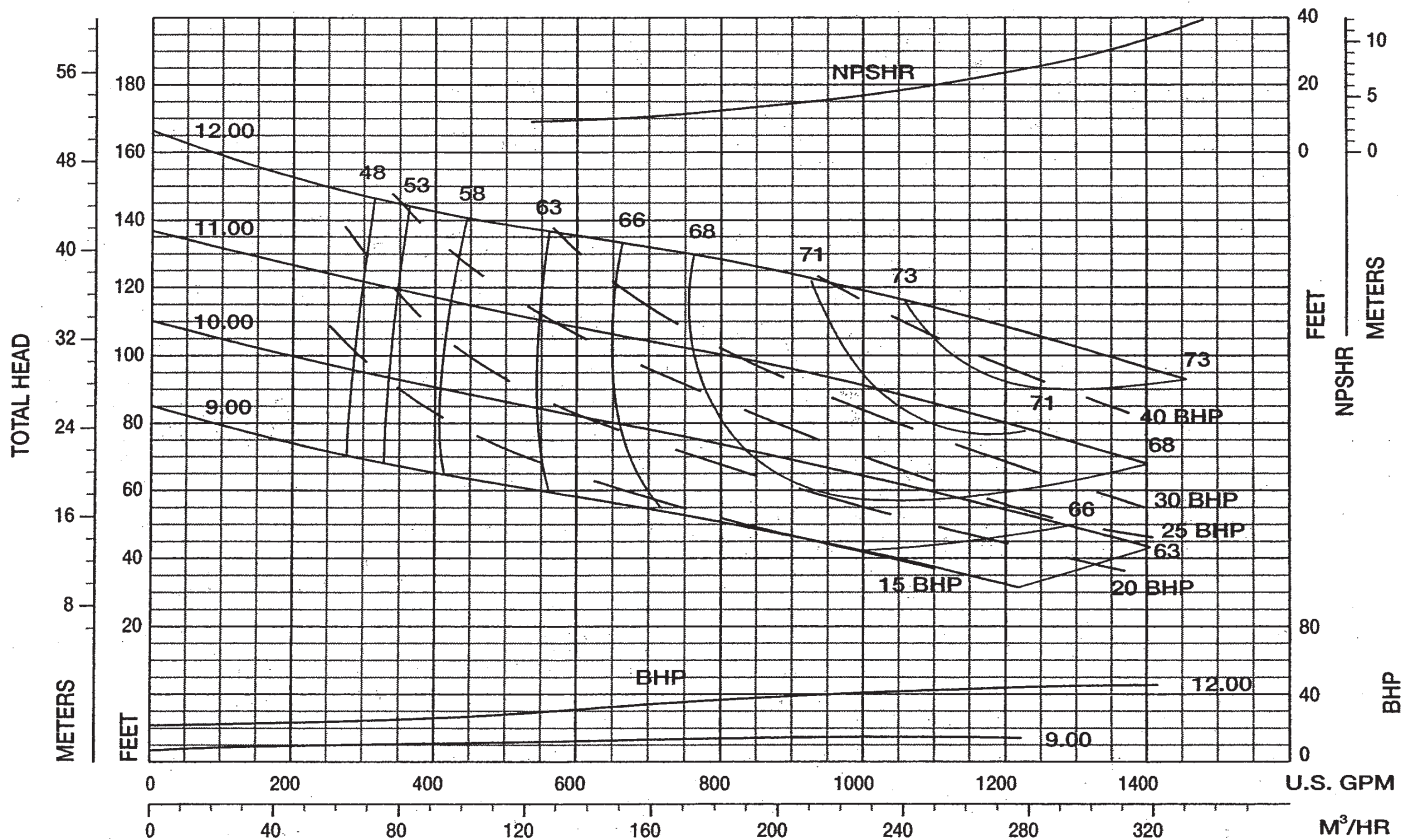

Performance Curve - 4" 5433 MVK

RPM: 1770 SOLIDS: 3"

IMPELLER: T4C1AA, BLADELESS SUCTION: 4" INLET: 23.77 in²

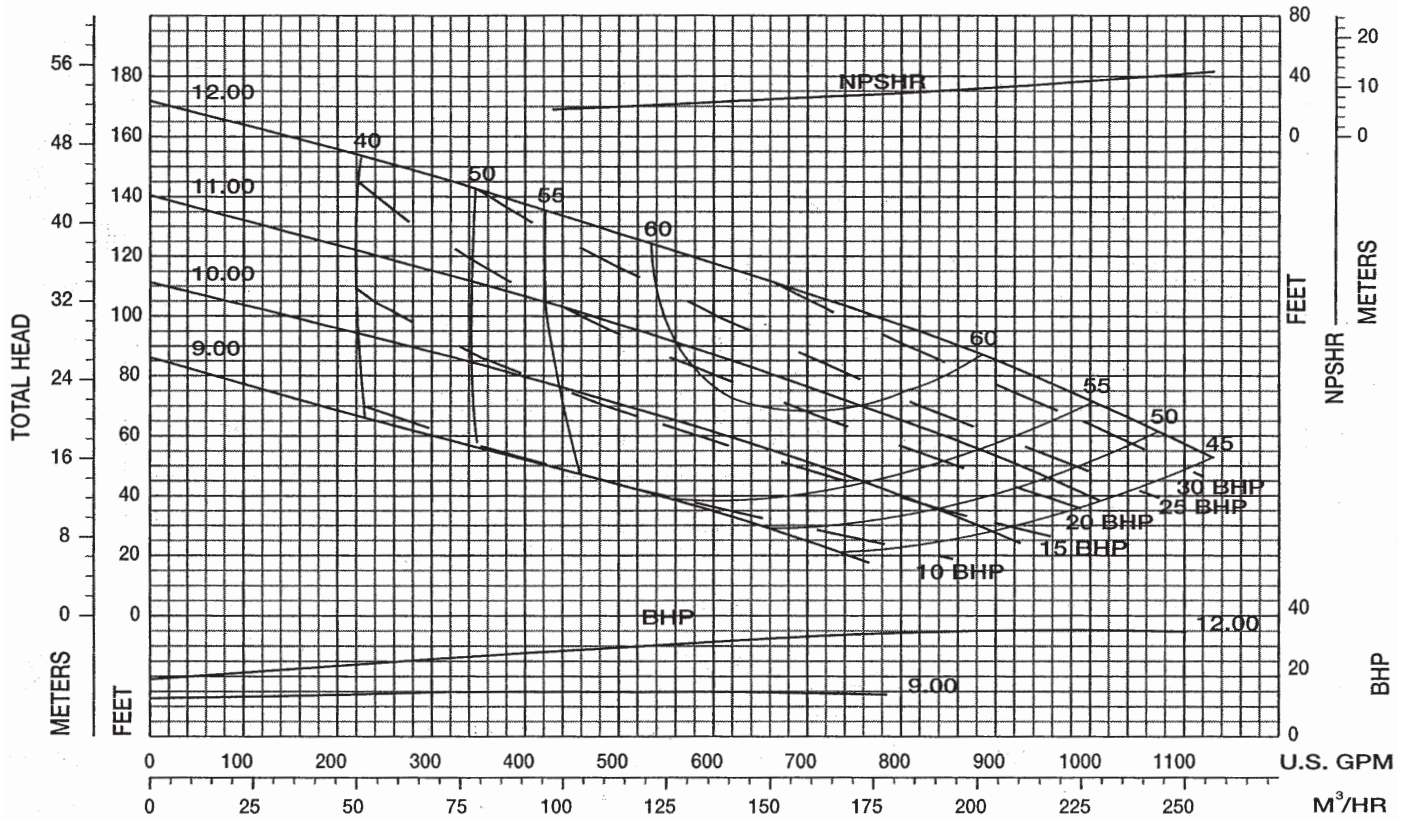

Performance Curve - 4" 5433 MV

RPM: 1770 SOLIDS: 3"

IMPELLER: T4C1A, 2 VANE SUCTION: 4" INLET: 26.22 in²

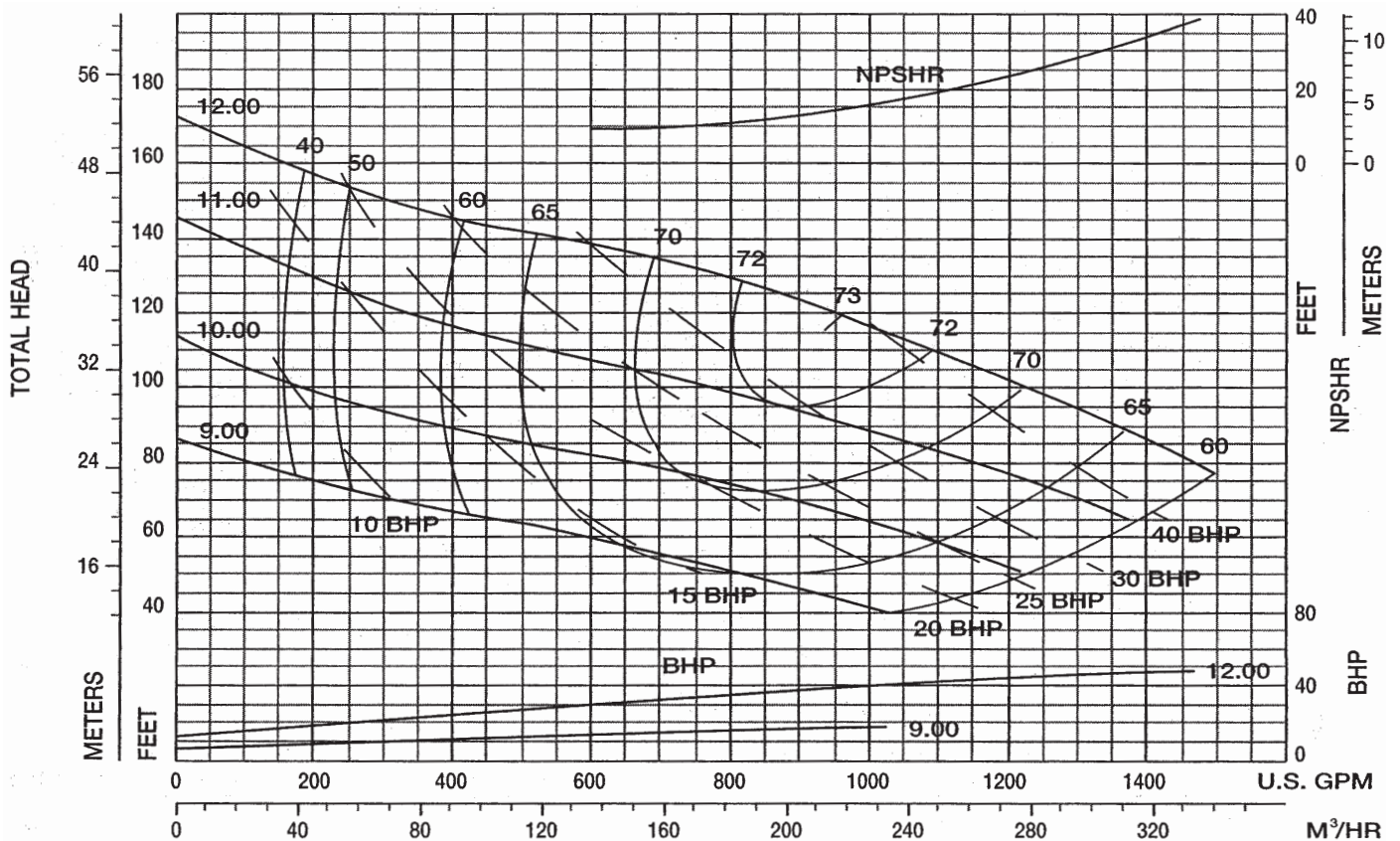

Performance Curve - 4" D5433 MV

RPM: 1770 SOLIDS: 3"

IMPELLER: T4C1NA, 2 VANE SUCTION: 4" INLET: 26.22 in²

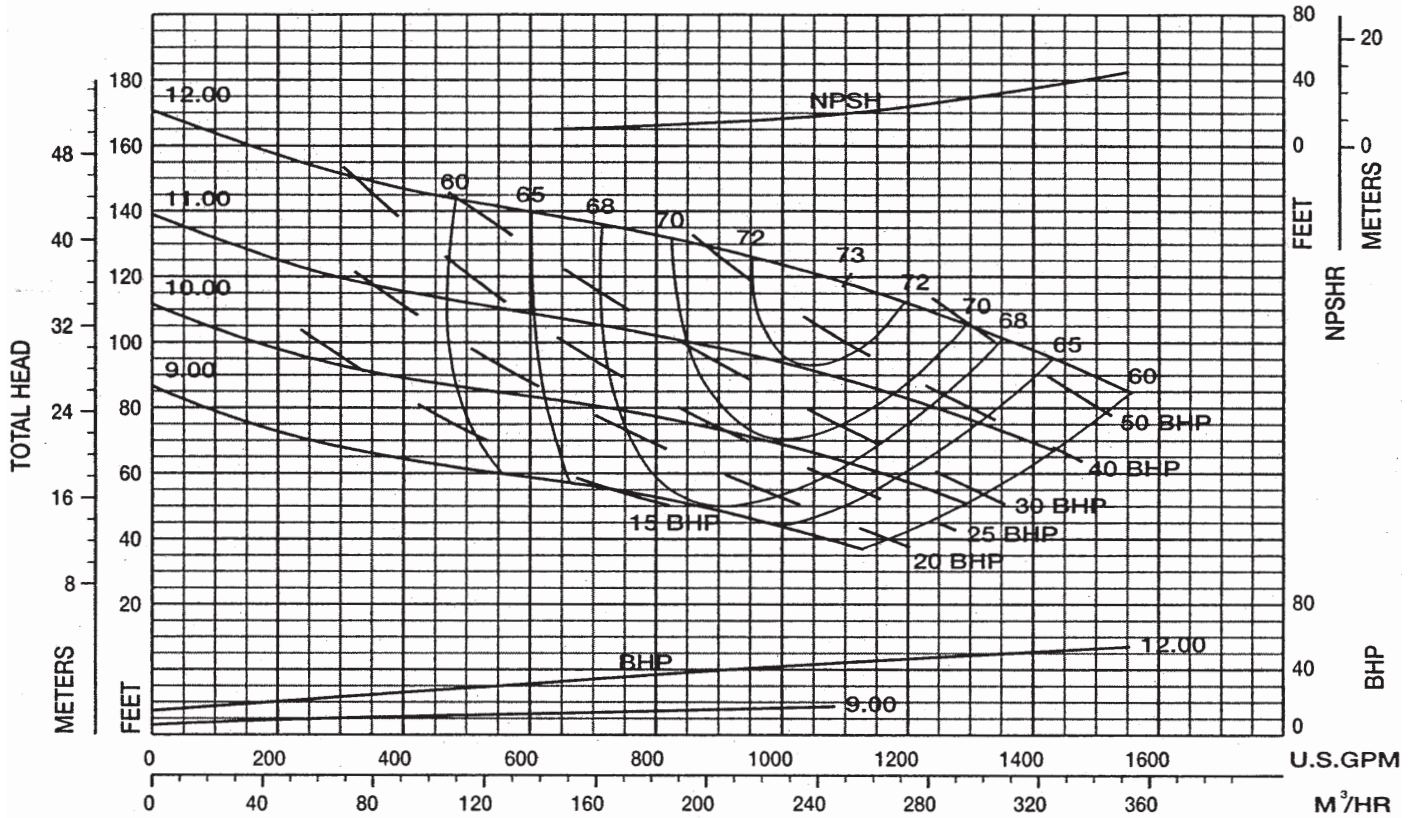

Performance Curve - 5" 5433 MVK, MTK, WK, WDK

RPM: 1770 SOLIDS: 3-1/2"

IMPELLER: T5C1AG, BLADELESS SUCTION: 5" (WDK: 5" or 6") INLET: 37.69 in²

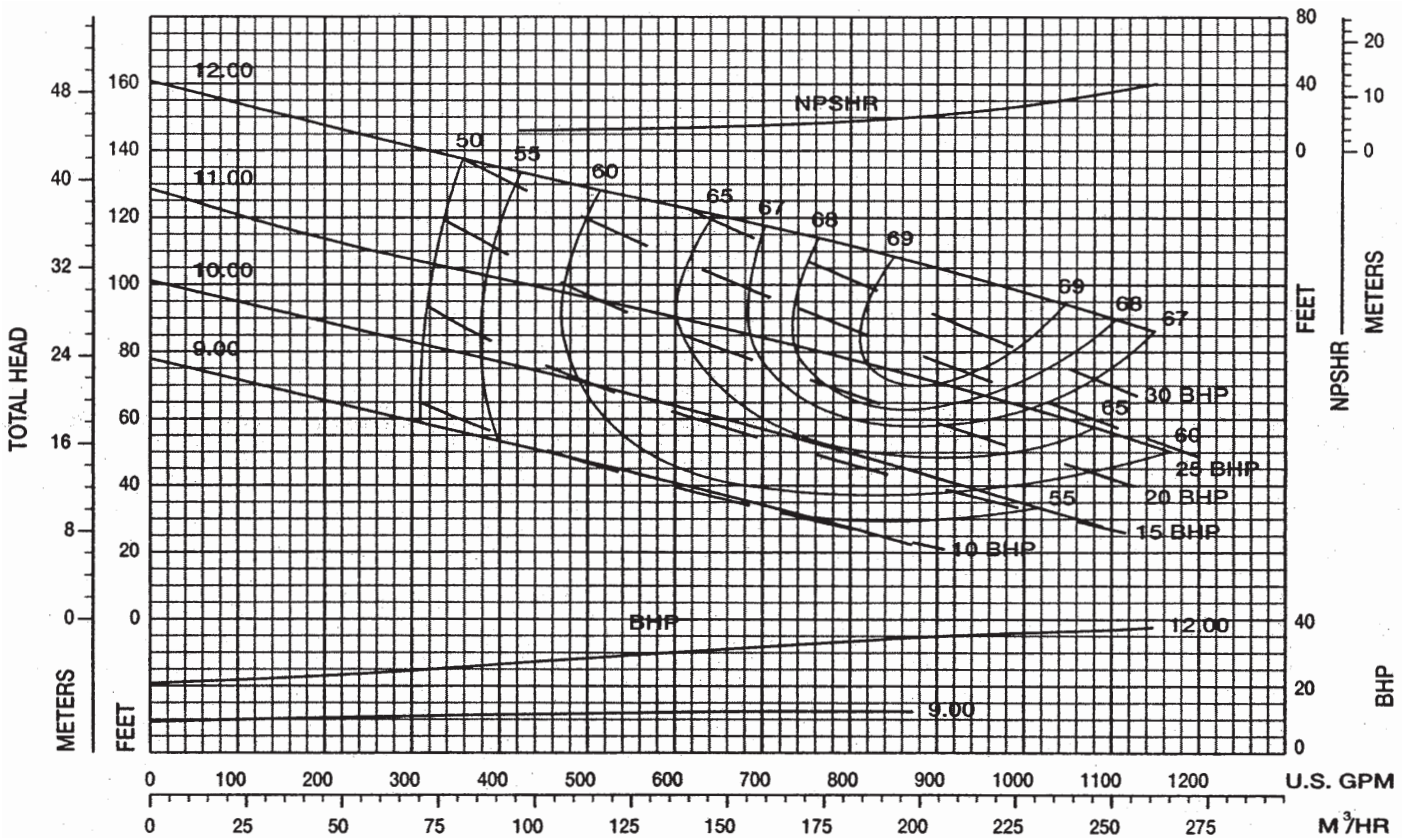

Performance Curve – 5" 5433 MV, MT, W, WD

RPM: 1770 SOLIDS: 3-1/2"

IMPELLER: T5C1A, 2 VANE SUCTION: 5" (WD: 5", 6" or 8") INLET: 46.43 in²

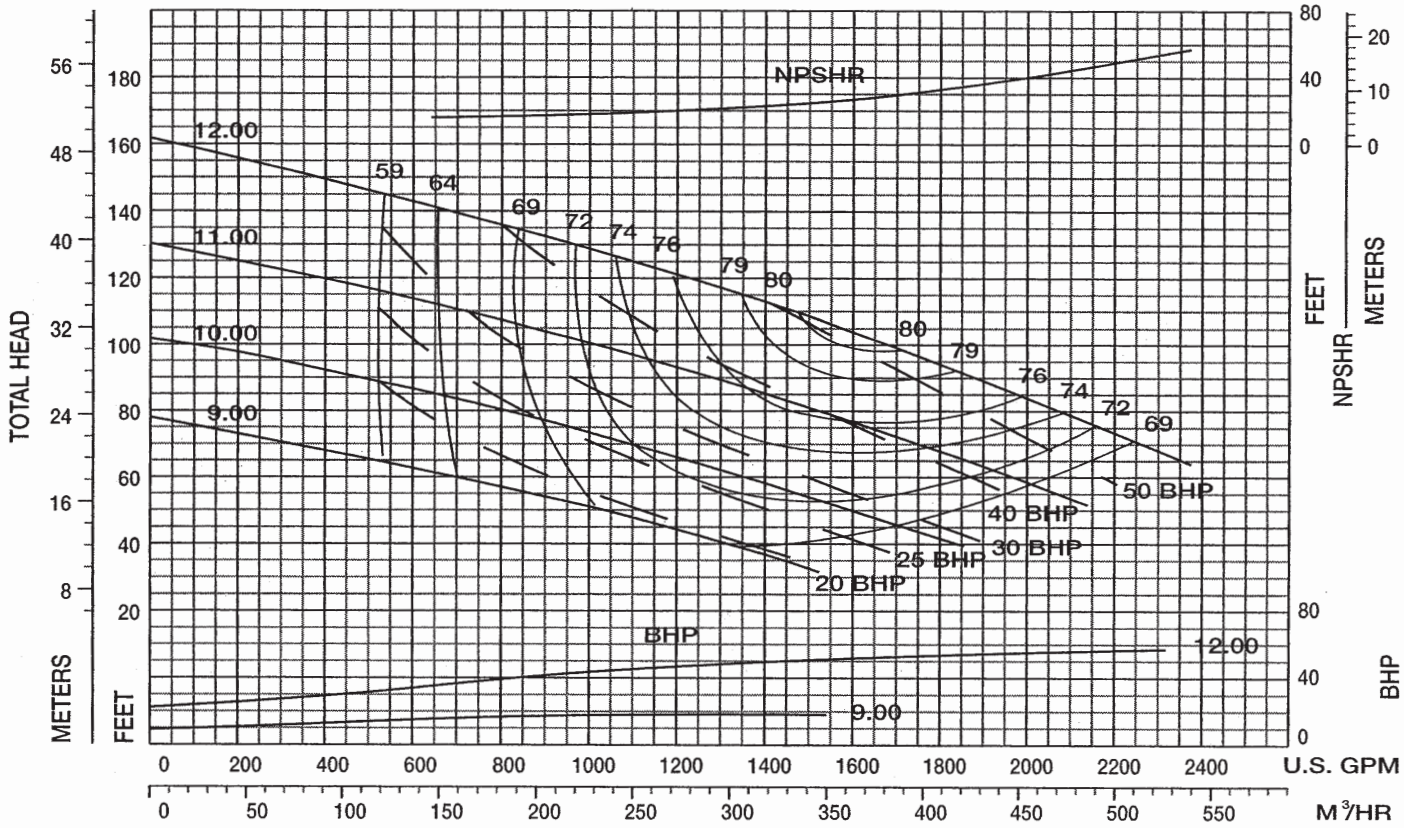

Performance Curve – 6" 5433 MT, W, WD

RPM: 1770 SOLIDS: 3"

IMPELLER: T6C1C, 2 VANE SUCTION: 8" (WD: 6" or 8") INLET: 52.88 in²

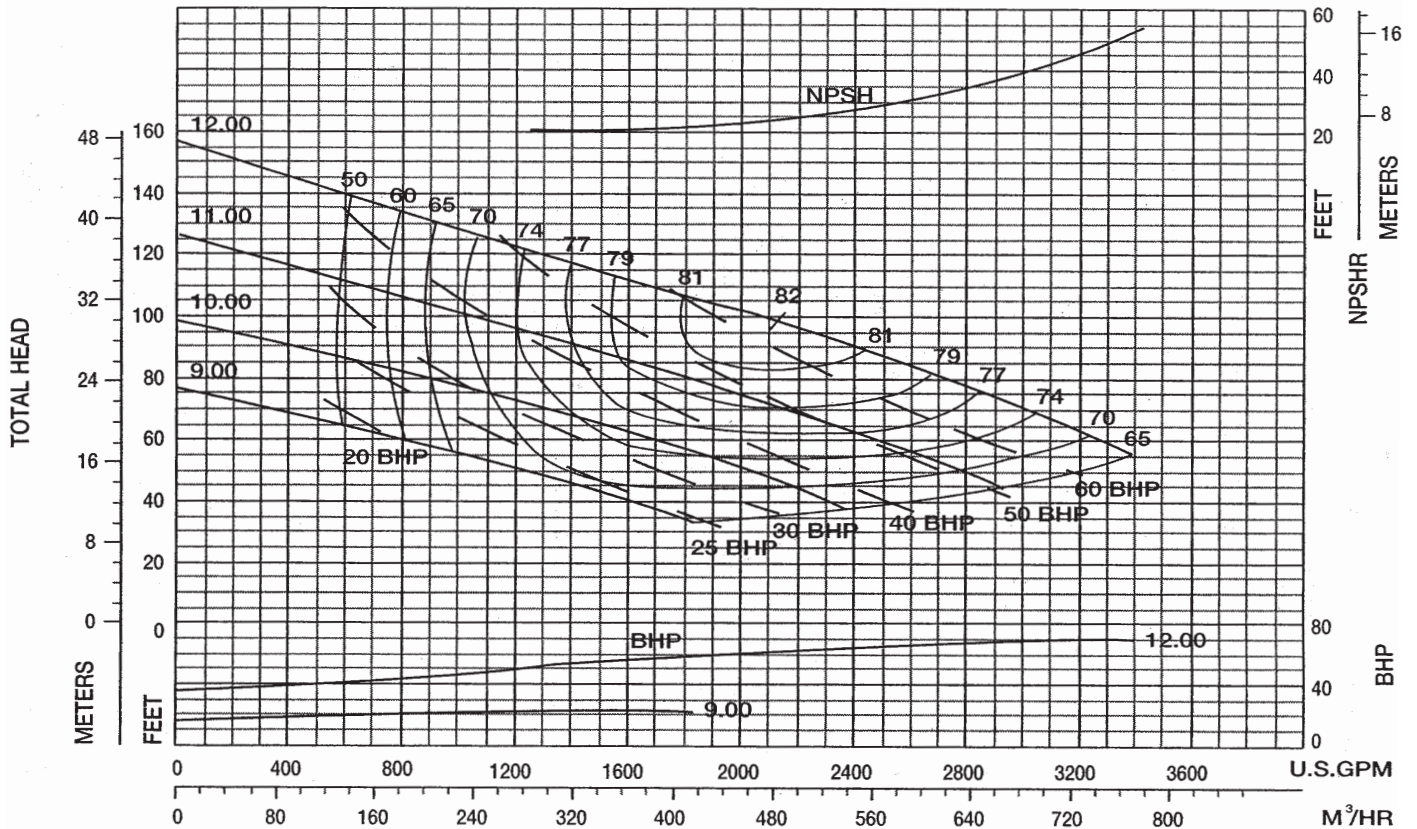

Performance Curve - 6" 5433 MV

RPM: 1770 SOLIDS: 3"

IMPELLER: T6C1C, 2 VANE SUCTION: 6" INLET: 52.88 in²

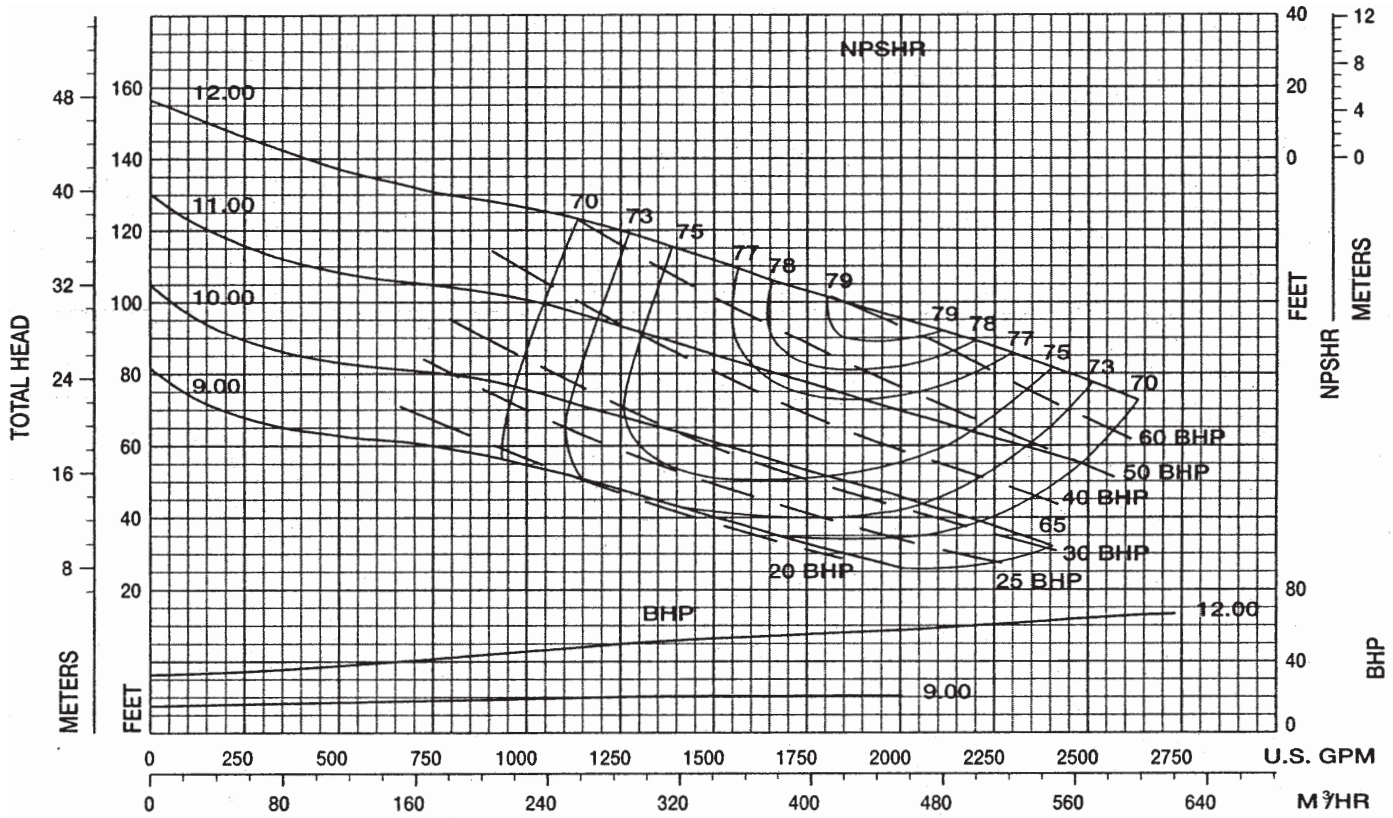

Performance Curve - 4" 5434 MT, W, WD

RPM: 1785 SOLIDS: 3"

IMPELLER: T4D1B, 2 VANE SUCTION: 5" (WD: 5", 6" or 8") INLET: 47.01 in²

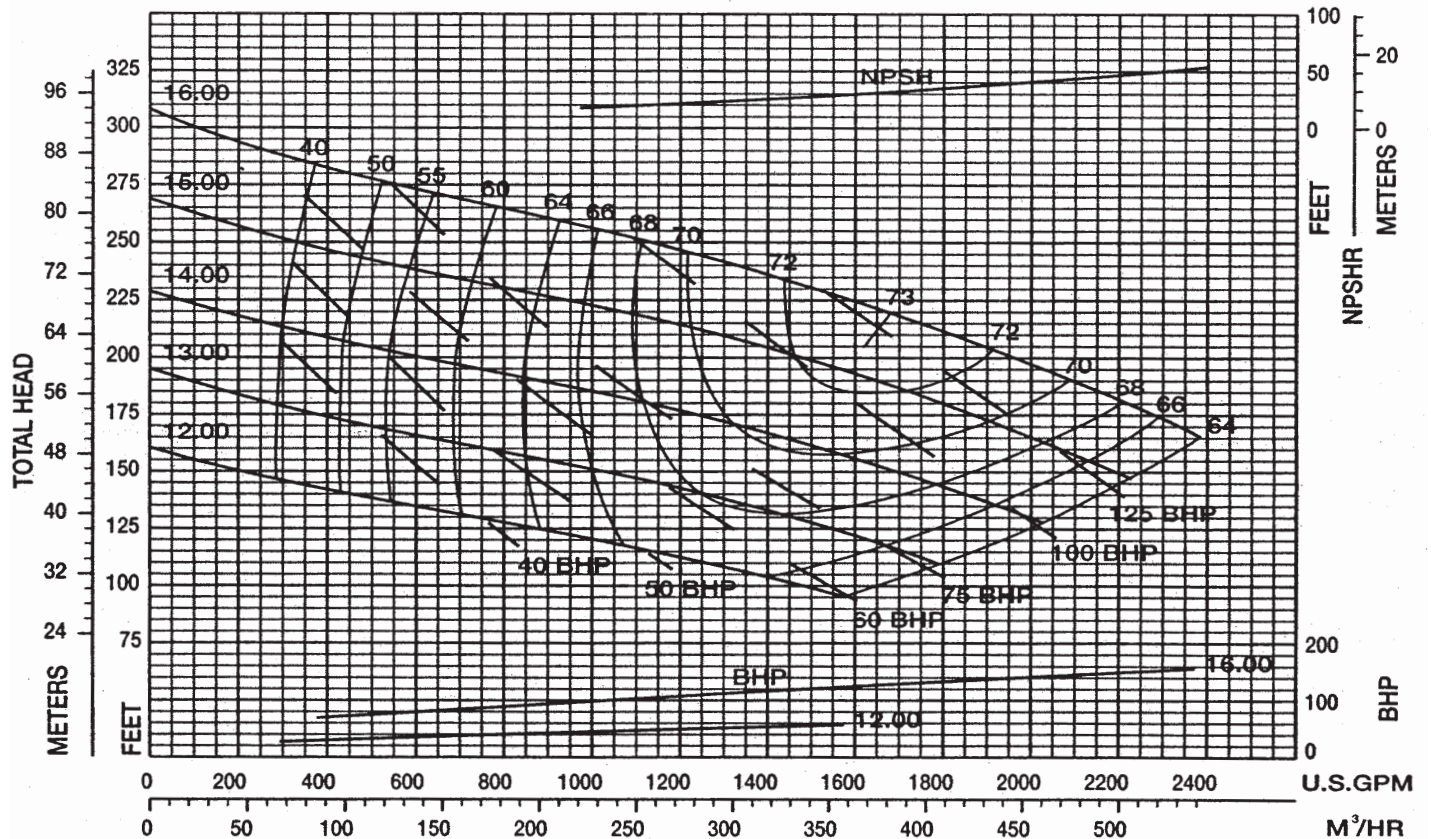

Performance Curve – 4" 5434 MV

RPM: 1780 SOLIDS: 3"

IMPELLER: T4D1B, 2 VANE SUCTION: 4" INLET: 47.01 in²

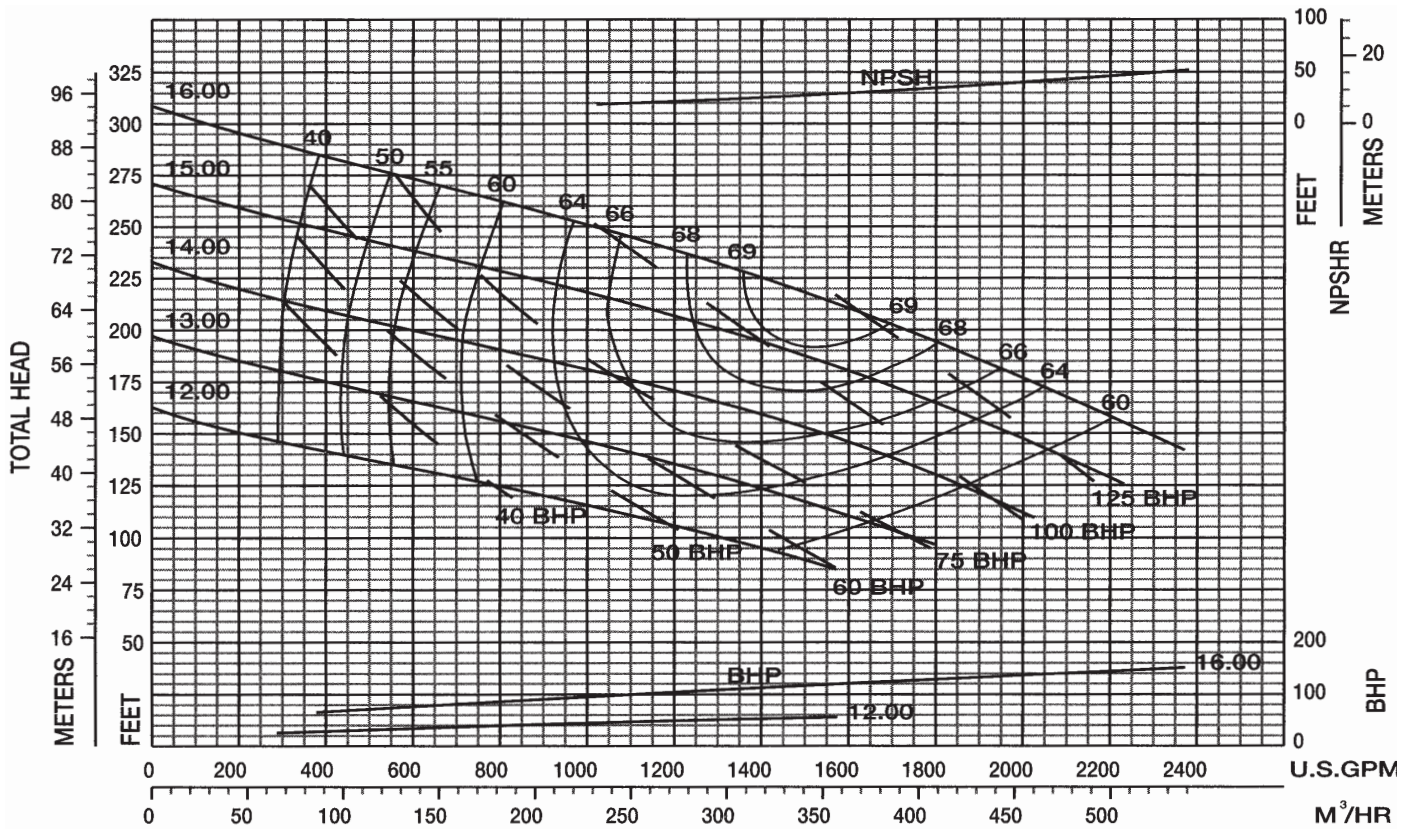

Performance Curve – 4" 5435 MT, W, WD

RPM: 1770 SOLIDS: 3"

IMPELLER: T4E1E, 2 VANE SUCTION: 4" (WD: 4" or 6") INLET: 35.65 in²

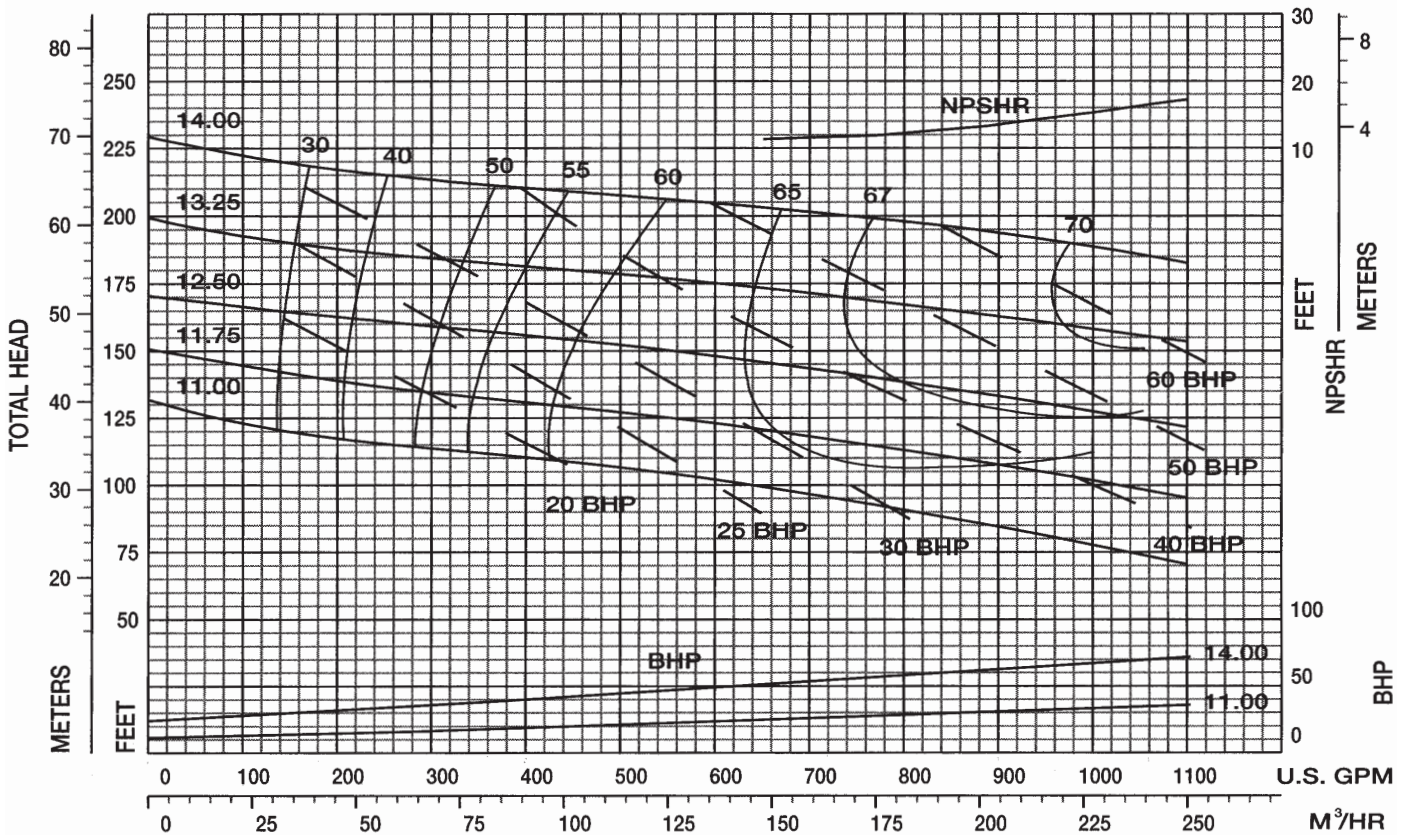

Performance Curve – 4" 5435 MV

RPM: 1780 SOLIDS: 3"

IMPELLER: T4E1E, 2 VANE SUCTION: 4" INLET: 35.65 in²

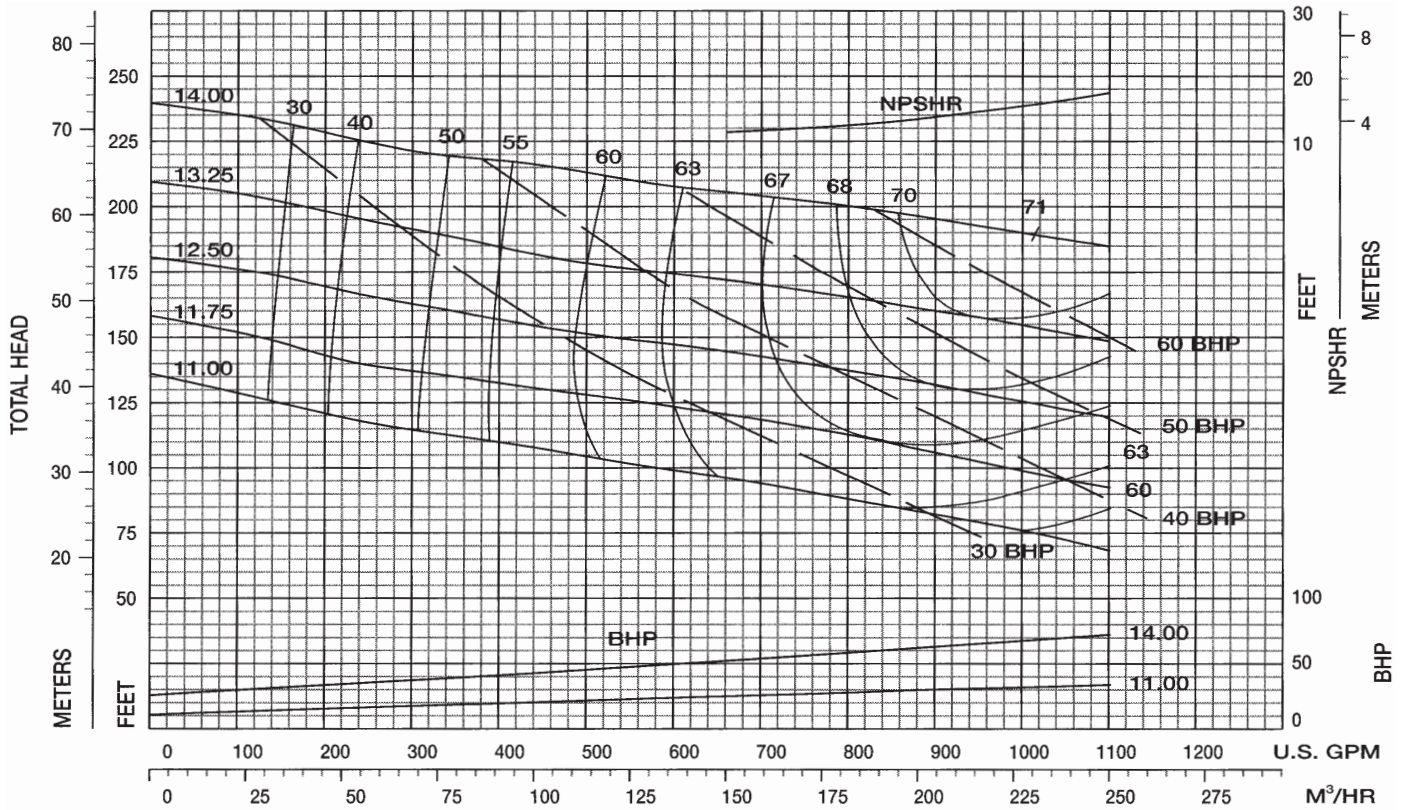

Performance Curve – 5" 5436 MT, W, WD

RPM: 1780 SOLIDS: 3"

IMPELLER: T5D1AS, 2 VANE SUCTION: 8" (WD: 8" or 10") INLET: 52.05 in²

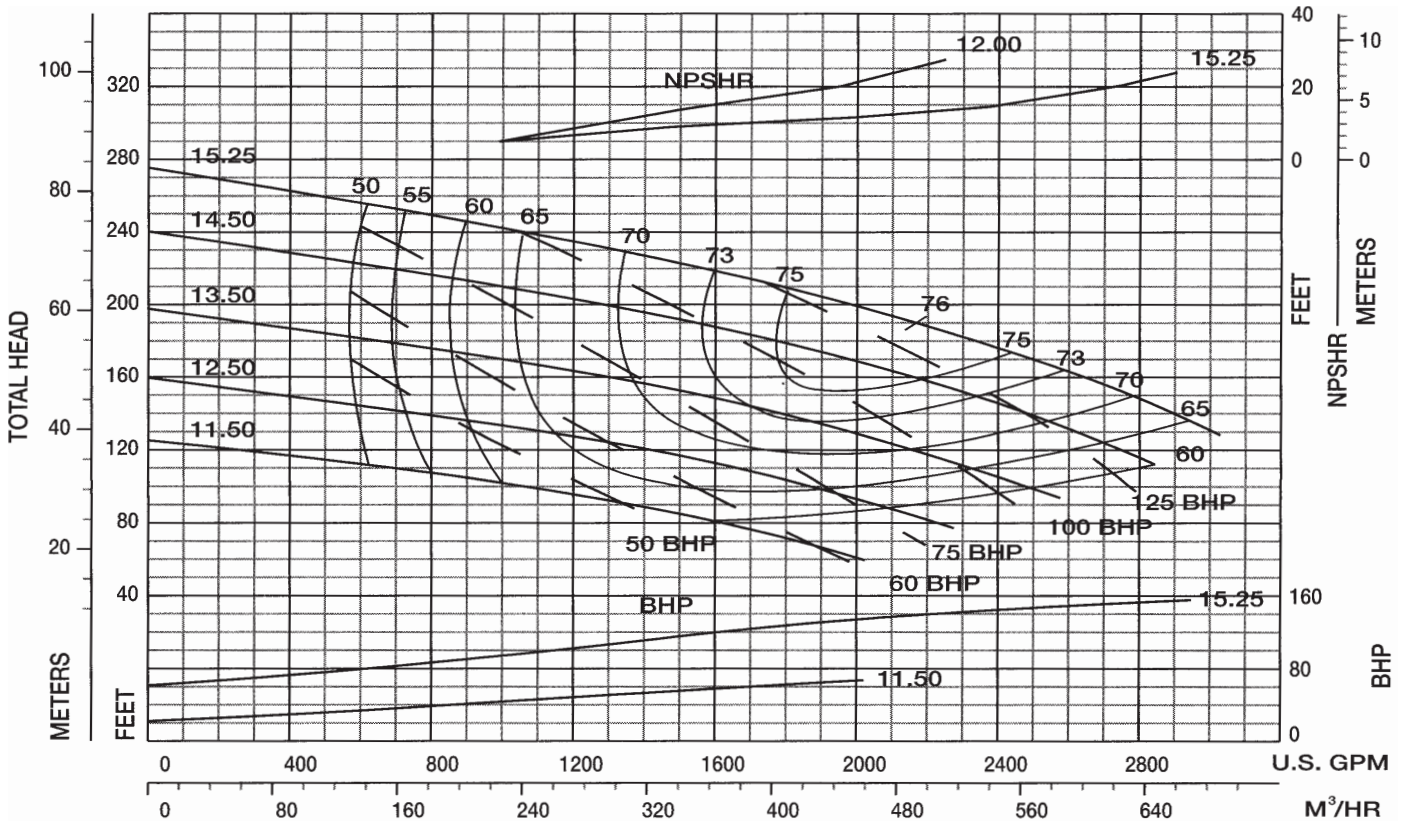

Performance Curve – 5" 5436 MV

RPM: 1780 SOLIDS: 3"

IMPELLER: T5D1AS, 2 VANE SUCTION: 5" INLET: 52.05 in²

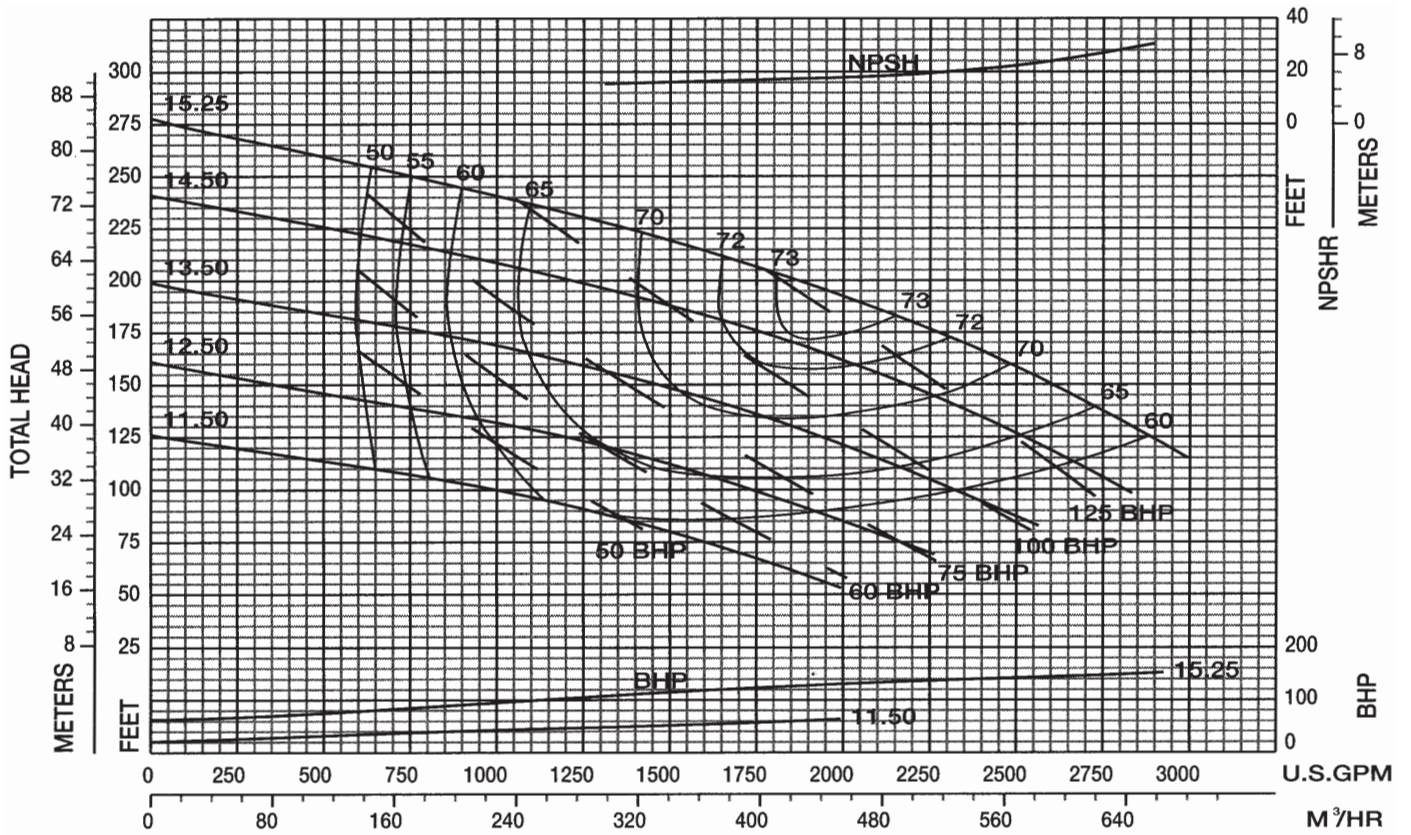

Performance Curve – 6" 5436L W, WD

RPM: 1785 SOLIDS: 3"

IMPELLER: T6F1C, 3 VANE SUCTION: 10" INLET: 93.30 in²

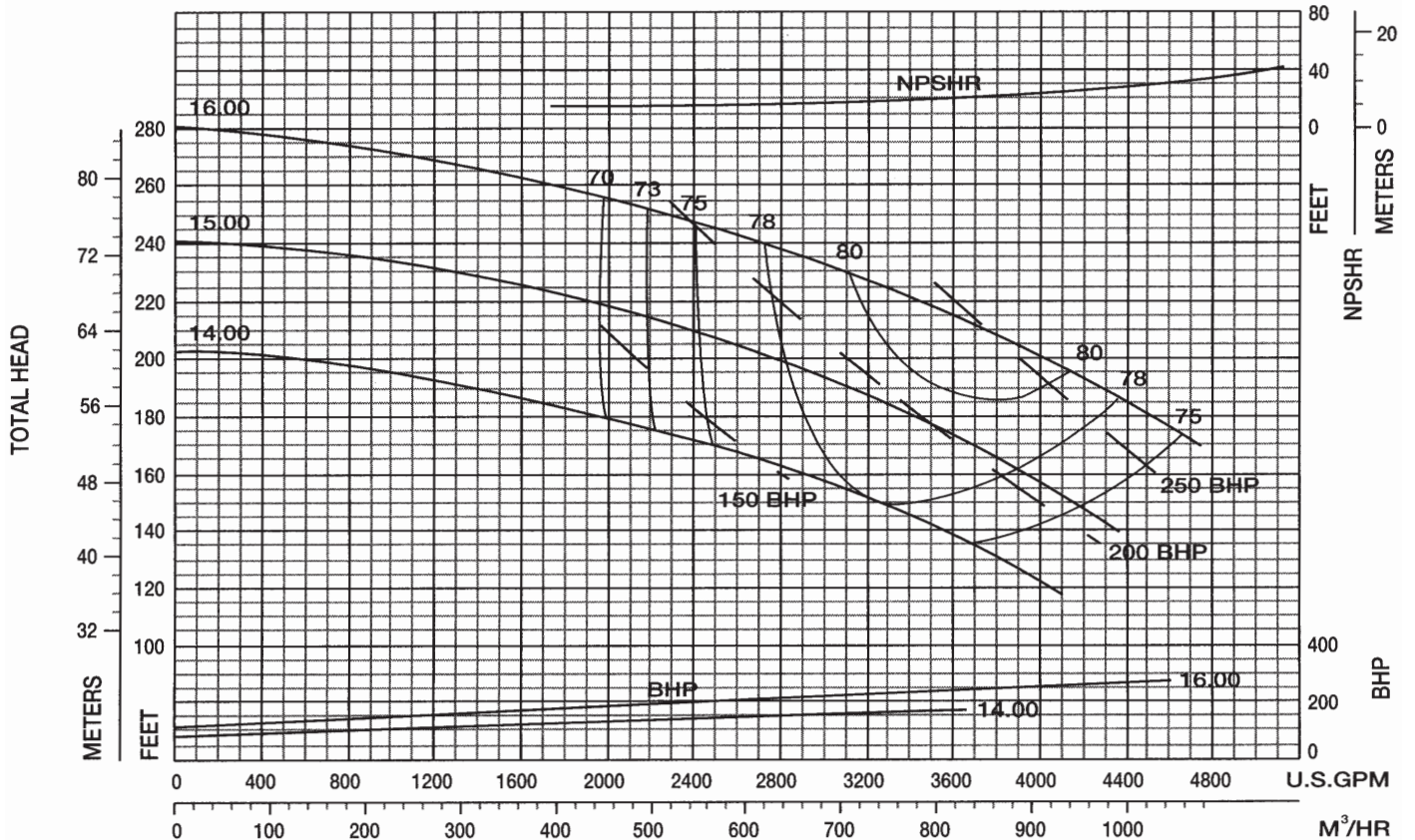

Performance Curve – 8" 5436S MT, W, WD

RPM: 1785 SOLIDS: 3"

IMPELLER: T8F1C, 3 VANE SUCTION: 10" INLET: 93.30 in²

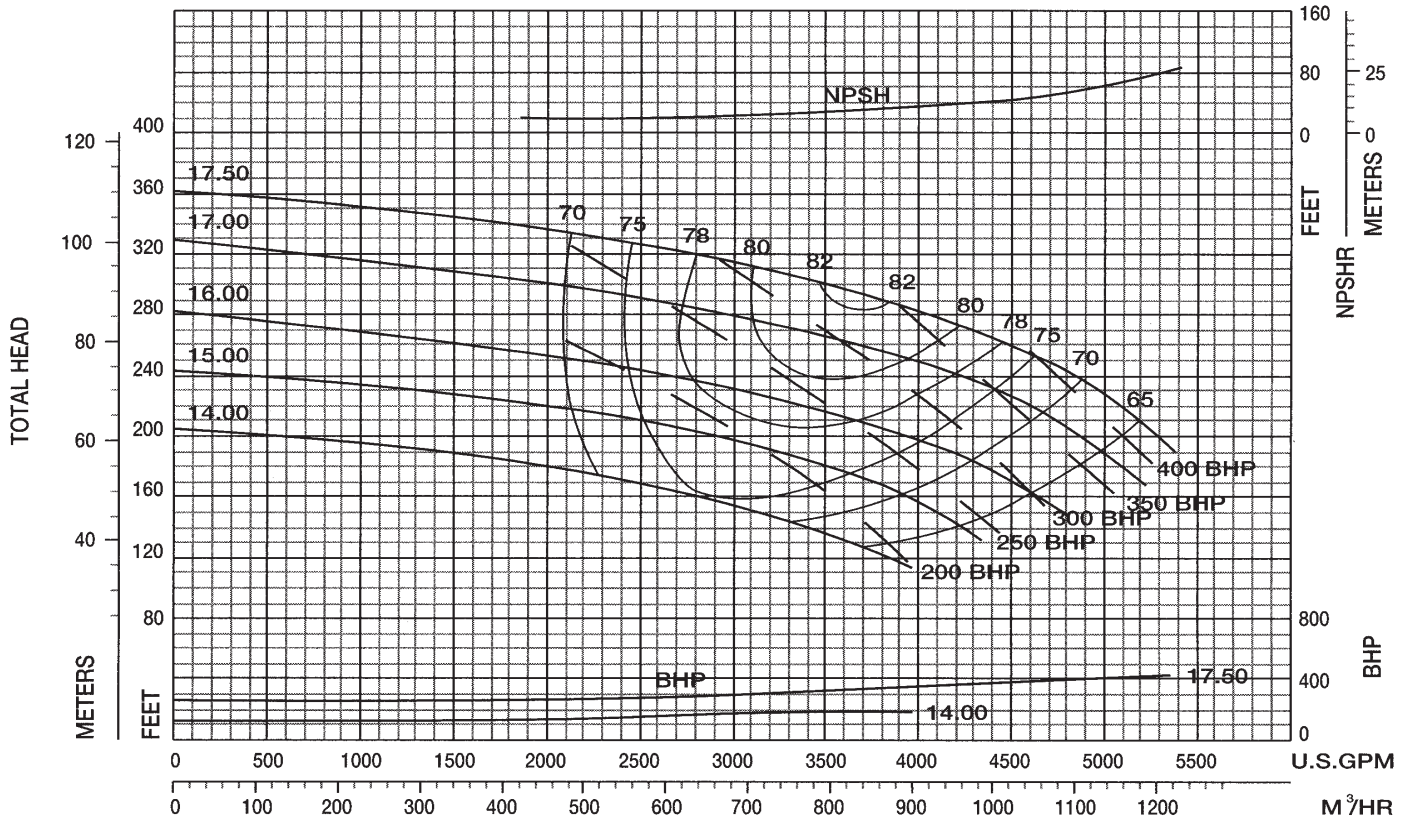

Performance Curve – 8" 5436S MV

RPM: 1785 SOLIDS: 3"

IMPELLER: T8F1C, 3 VANE SUCTION: 8" INLET: 93.30 in²

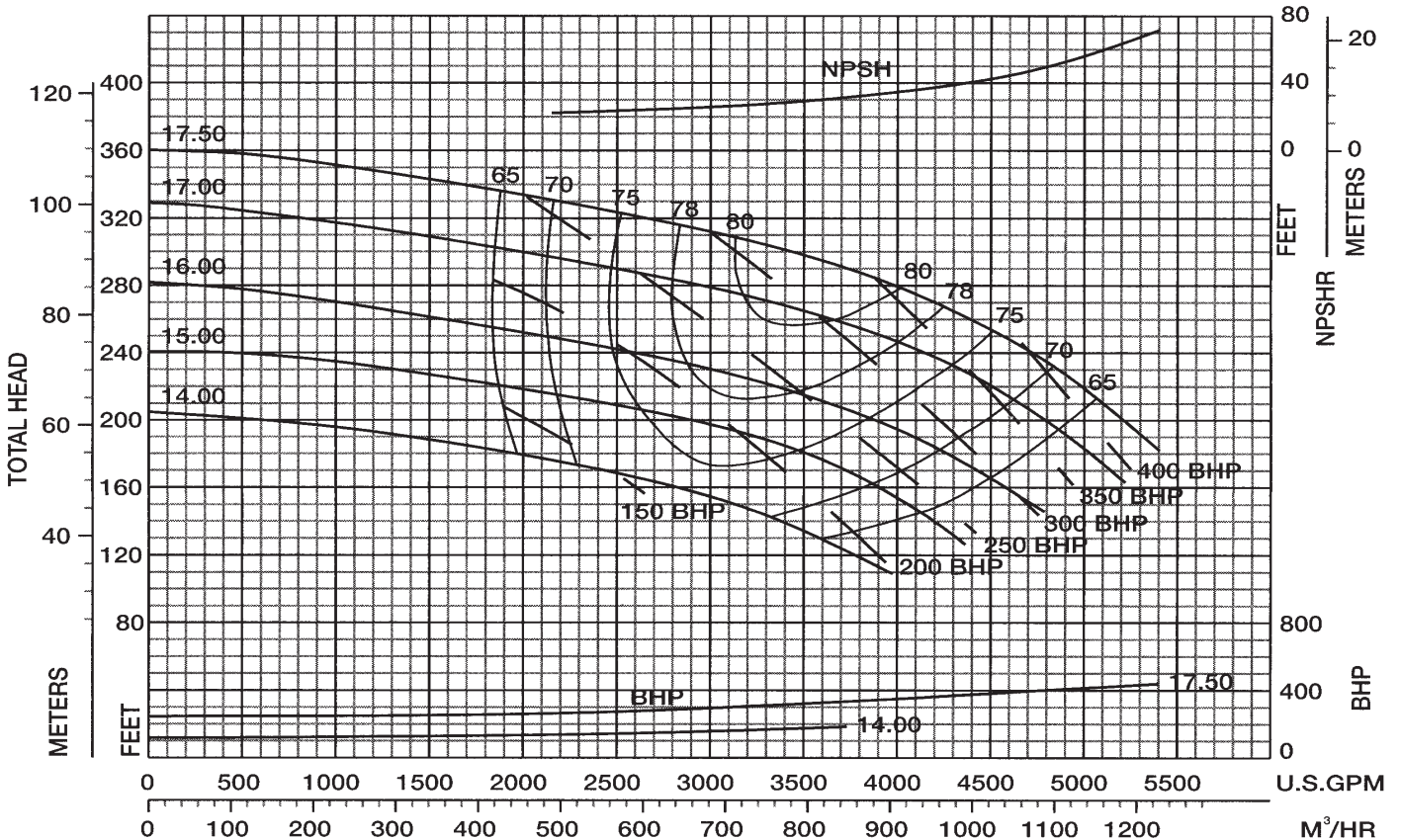

Performance Curve – 2" 5431 MTK, WK, WDK

RPM: 1150 SOLIDS: 1-1/2"

IMPELLER: T2A1X, BLADELESS SUCTION: 2" INLET: 6.51 in²

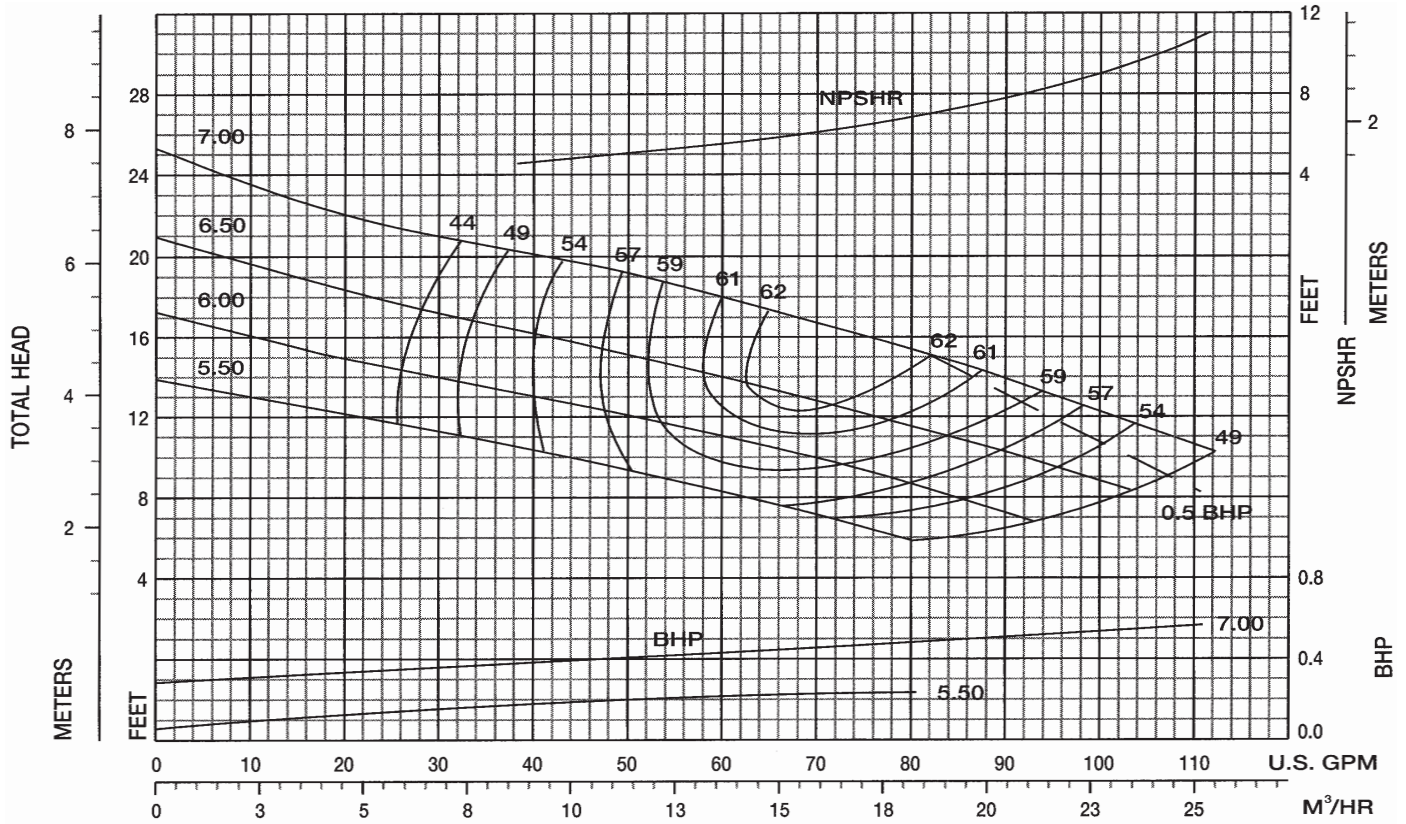

Performance Curve – 2" 5431 MT, W, WD

RPM: 1130 SOLIDS: 1-1/2"

IMPELLER: T2A1A, 2 VANE SUCTION: 2" INLET: 9.28 in²

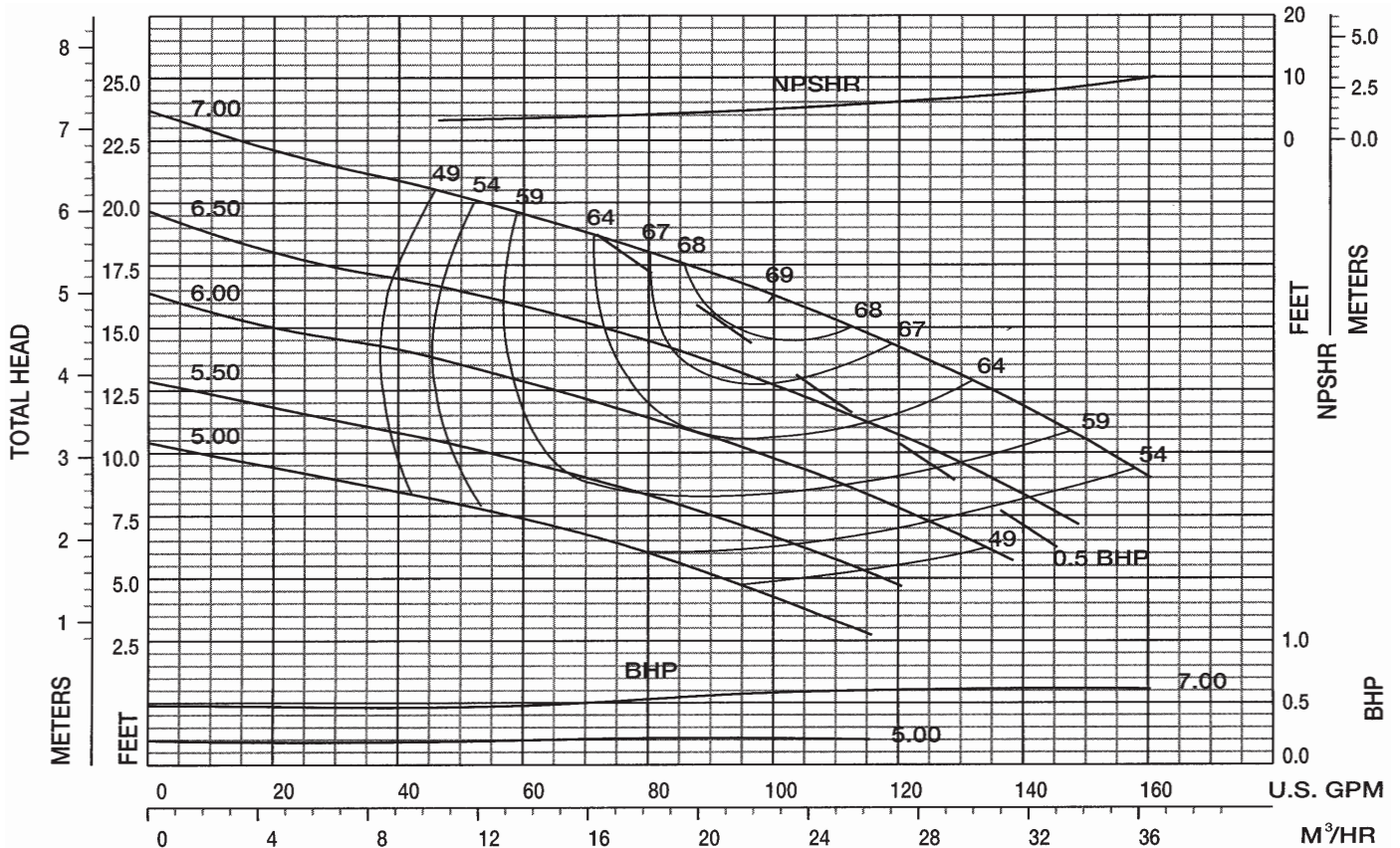

Performance Curve – 3" 5431 MTK, WK, WDK

RPM: 1130 SOLIDS: 2"

IMPELLER: T3A1X, BLADELESS SUCTION: 3" (WDK: 3" or 4") INLET: 11.41 in²

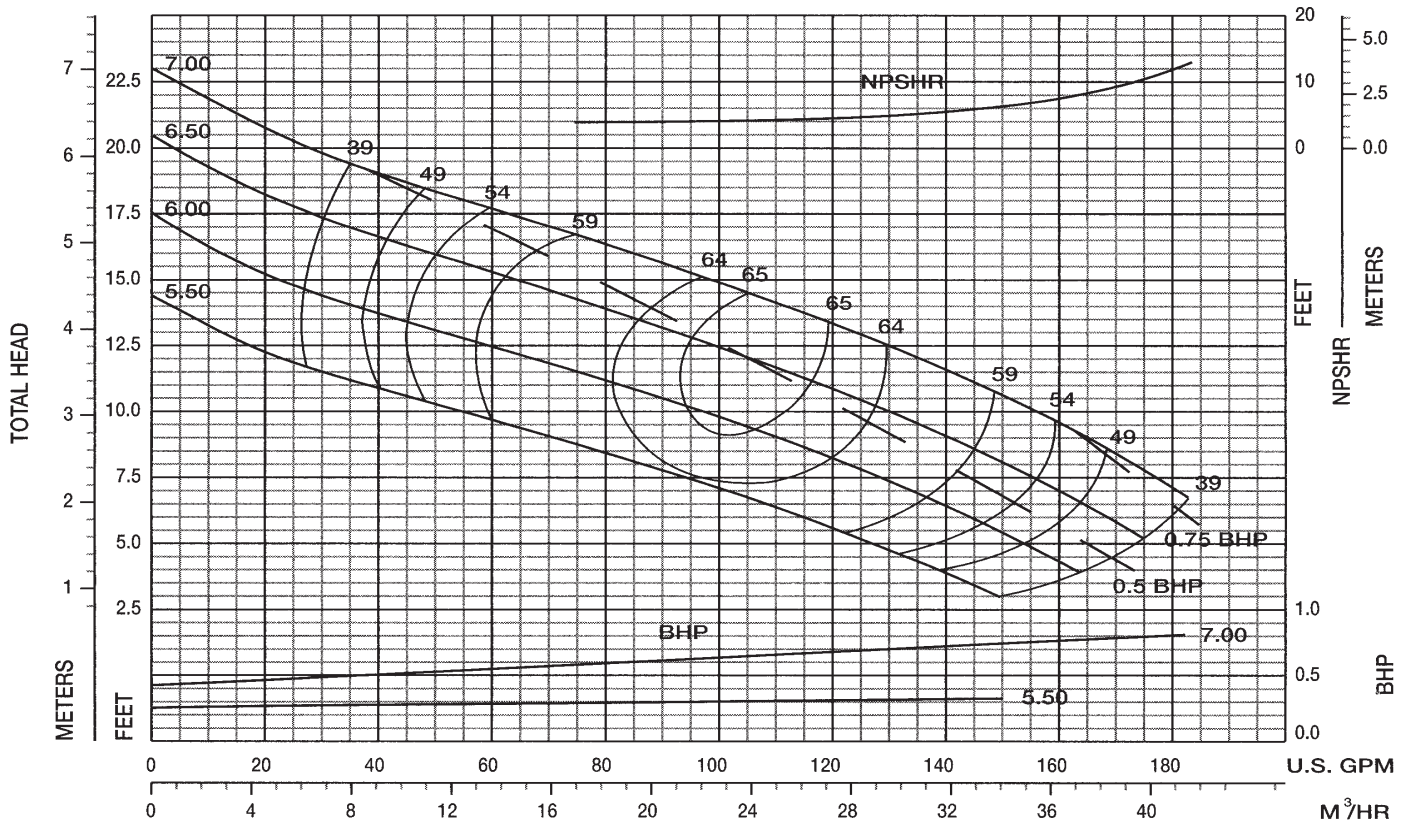

Performance Curve – 3" 5431 MT, W, WD

RPM: 1130 SOLIDS: 2"

IMPELLER: T3A1A, 2 VANE SUCTION: 3" (WD: 3" or 4") INLET: 13.20 in²

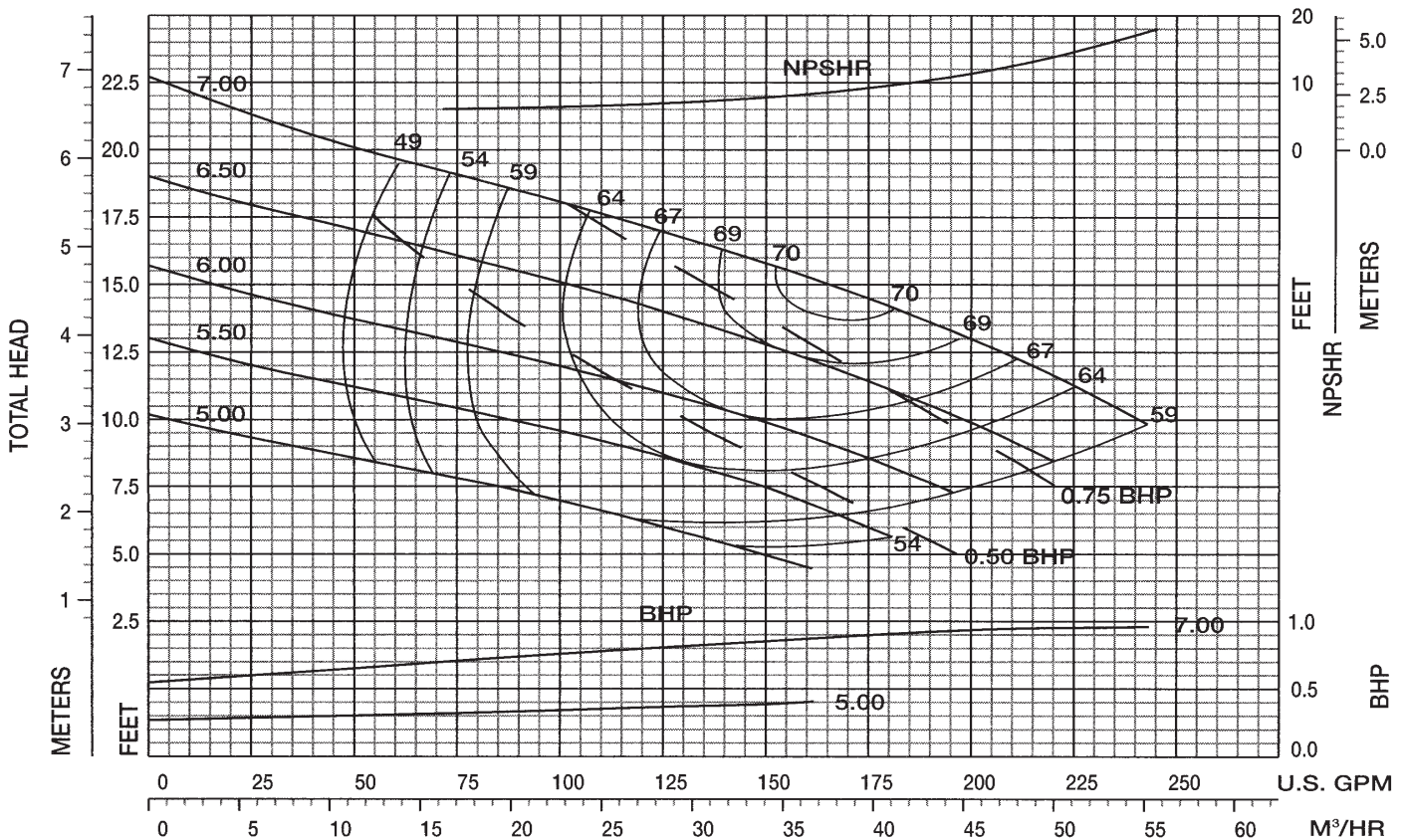

Performance Curve – 4" 5431 MTK, WK, WDK, CWDK

RPM: 1130 SOLIDS: 2-1/2"

IMPELLER: T4A1C, BLADELESS SUCTION: 4" (WDK: 4" or 6") INLET: 20.57 in²

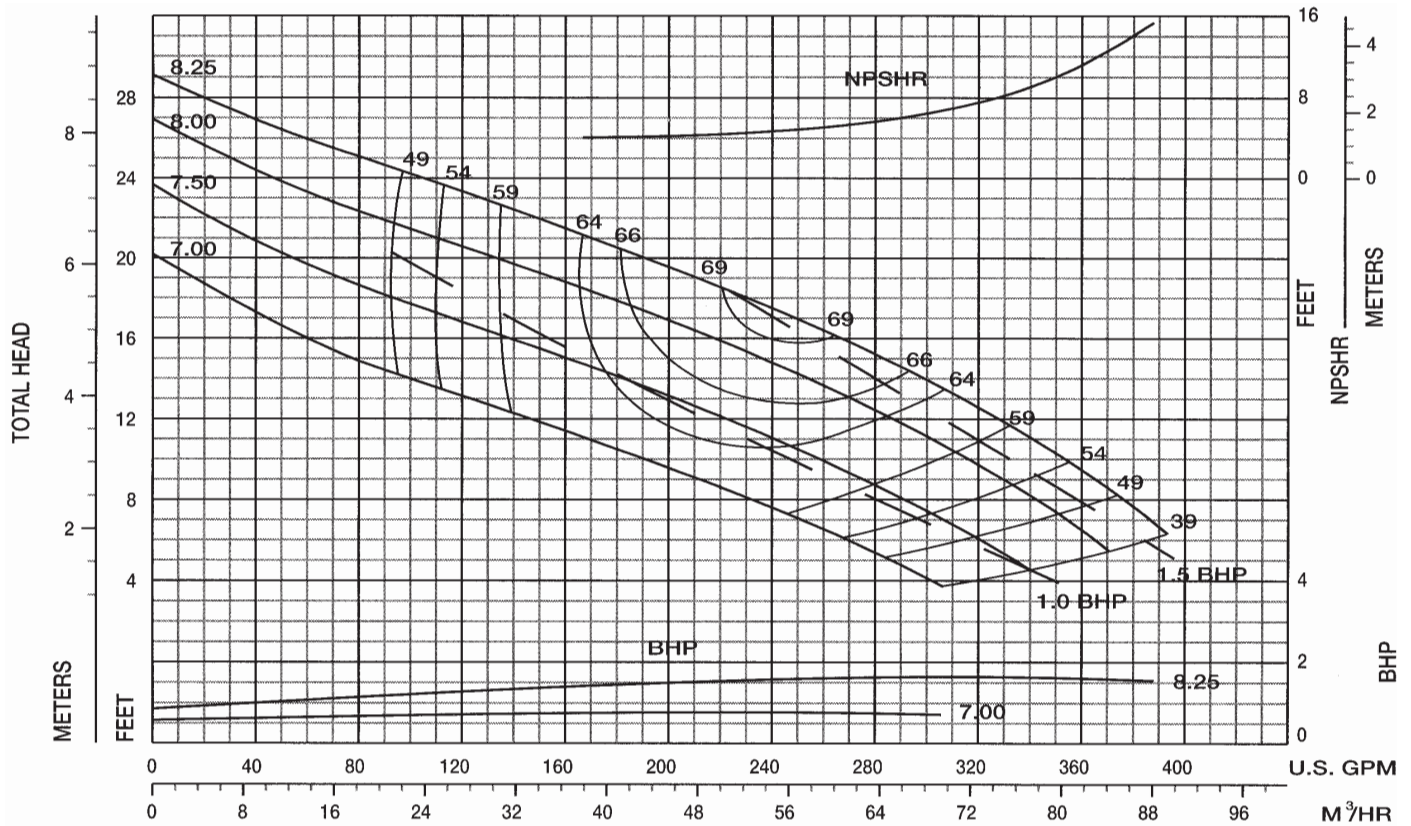

Performance Curve – 4" 5431 MT, W, WD, CWD

RPM: 1155 SOLIDS: 2-1/2"

IMPELLER: T4A1A, 2 VANE SUCTION: 4" (WD: 4" or 6") INLET: 23.49 in²

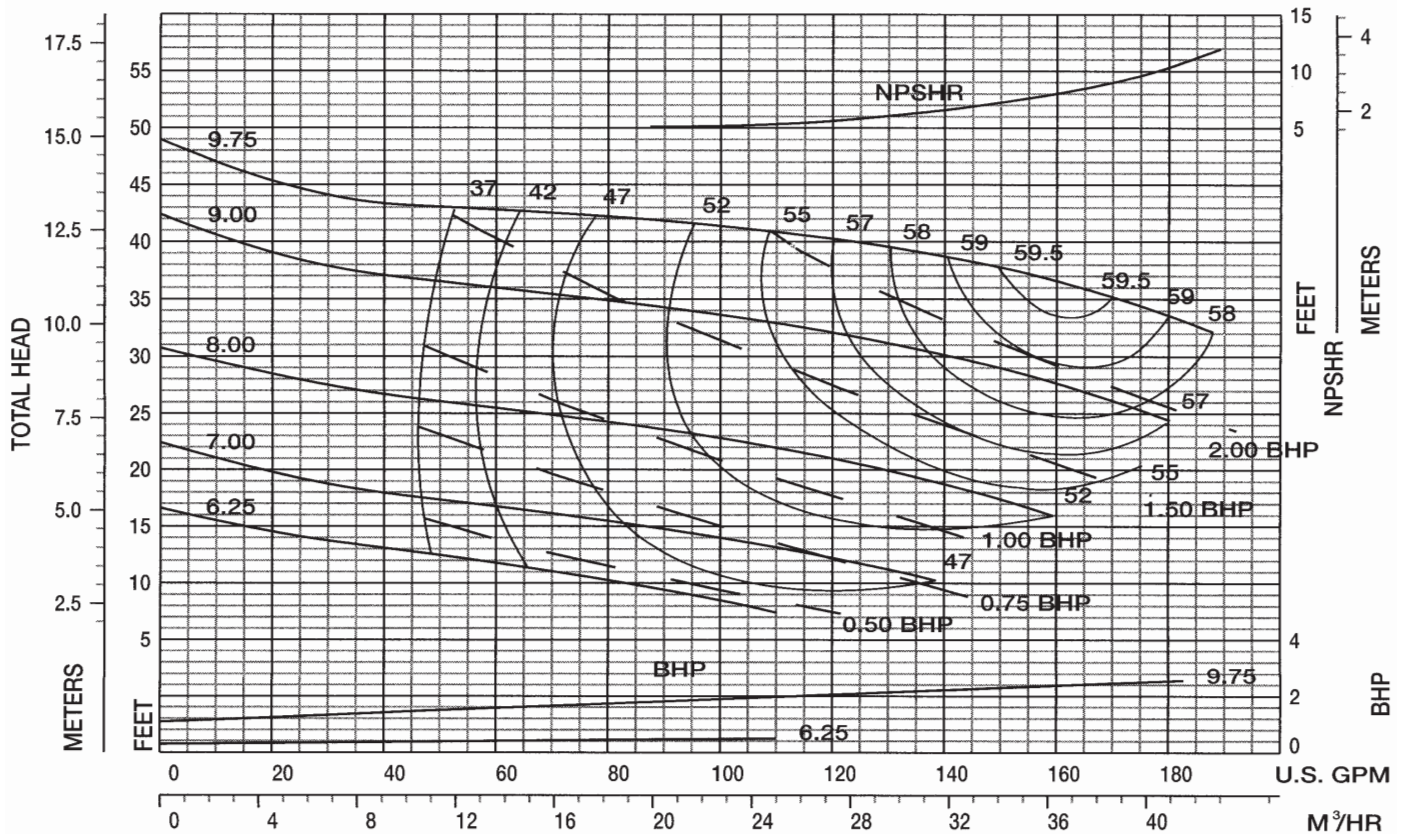

Performance Curve – 2" 5432 MTK, WK, WDK

RPM: 1130 SOLIDS: 1-1/2"

IMPELLER: T2B1AE, BLADELESS SUCTION: 2" INLET: 5.09 in²

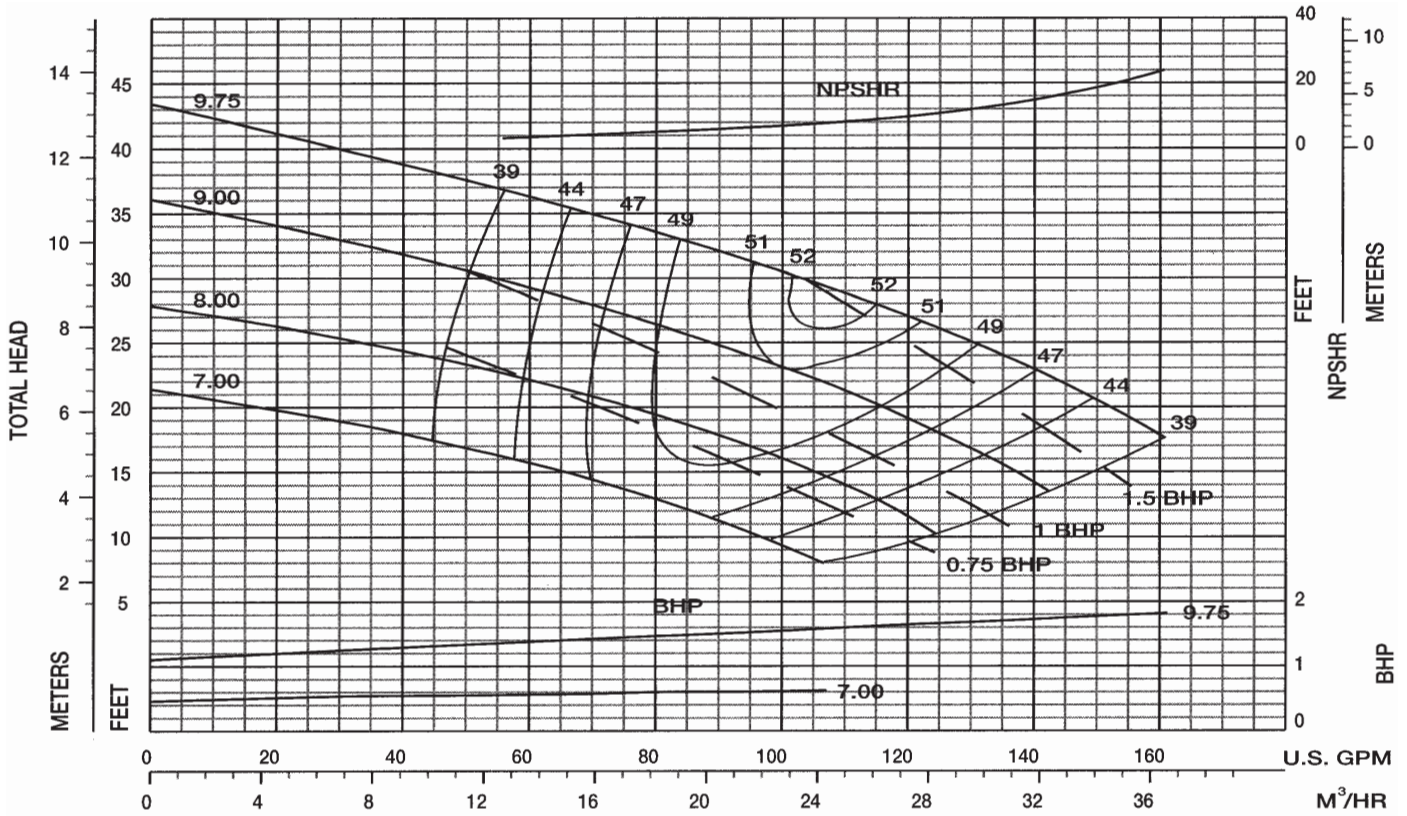

Performance Curve – 2" 5432 MT, W, WD

RPM: 1155 SOLIDS: 1-1/2"

IMPELLER: T2B1A, 2 VANE SUCTION: 2" INLET: 14.91 in²

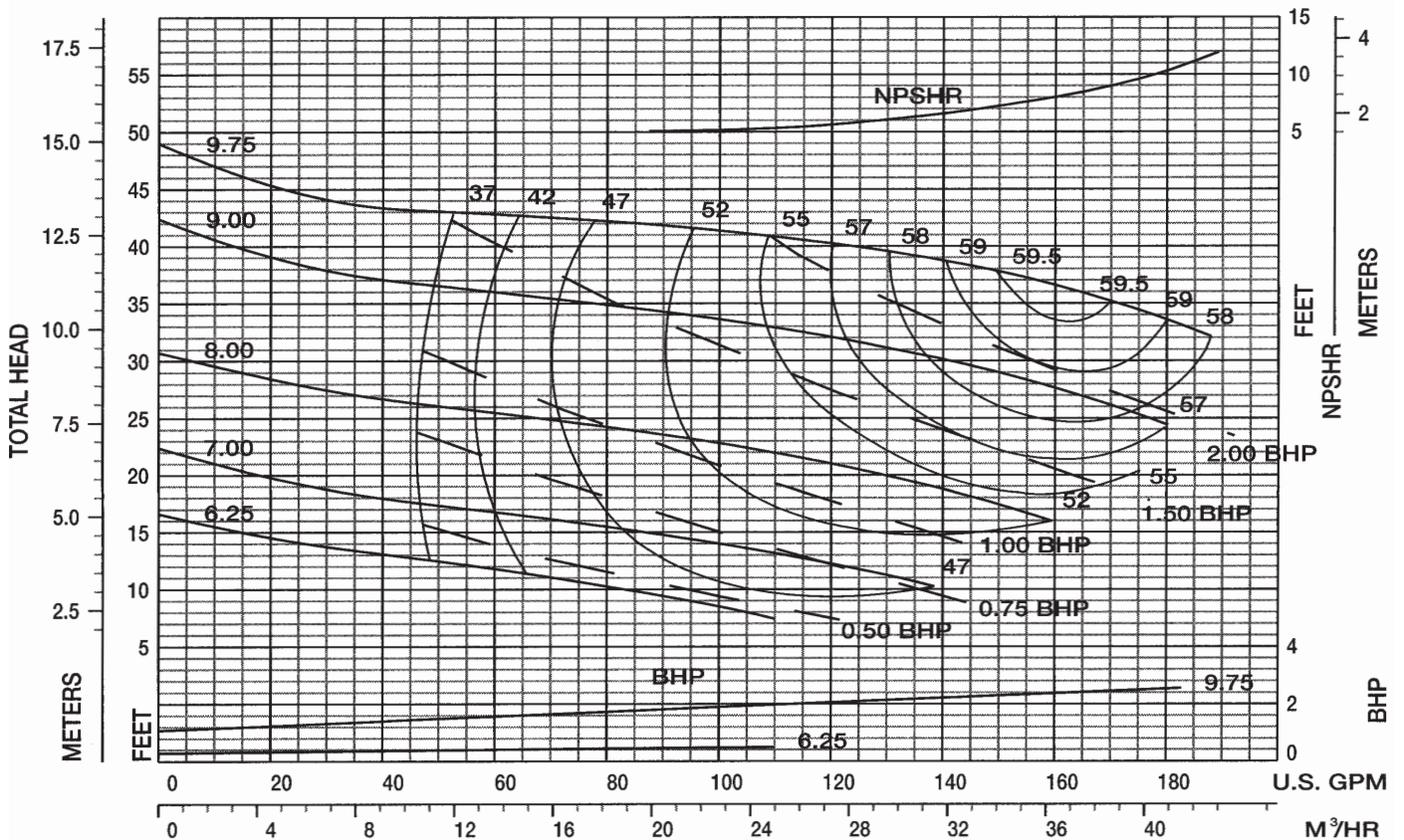

Performance Curve – 3" 5432 MTK, MVK, WK, WDK

RPM: 1155 SOLIDS: 2"

IMPELLER: T3B1AH, BLADELESS SUCTION: 3" (WDK: 3" or 4") INLET: 11.46 in²

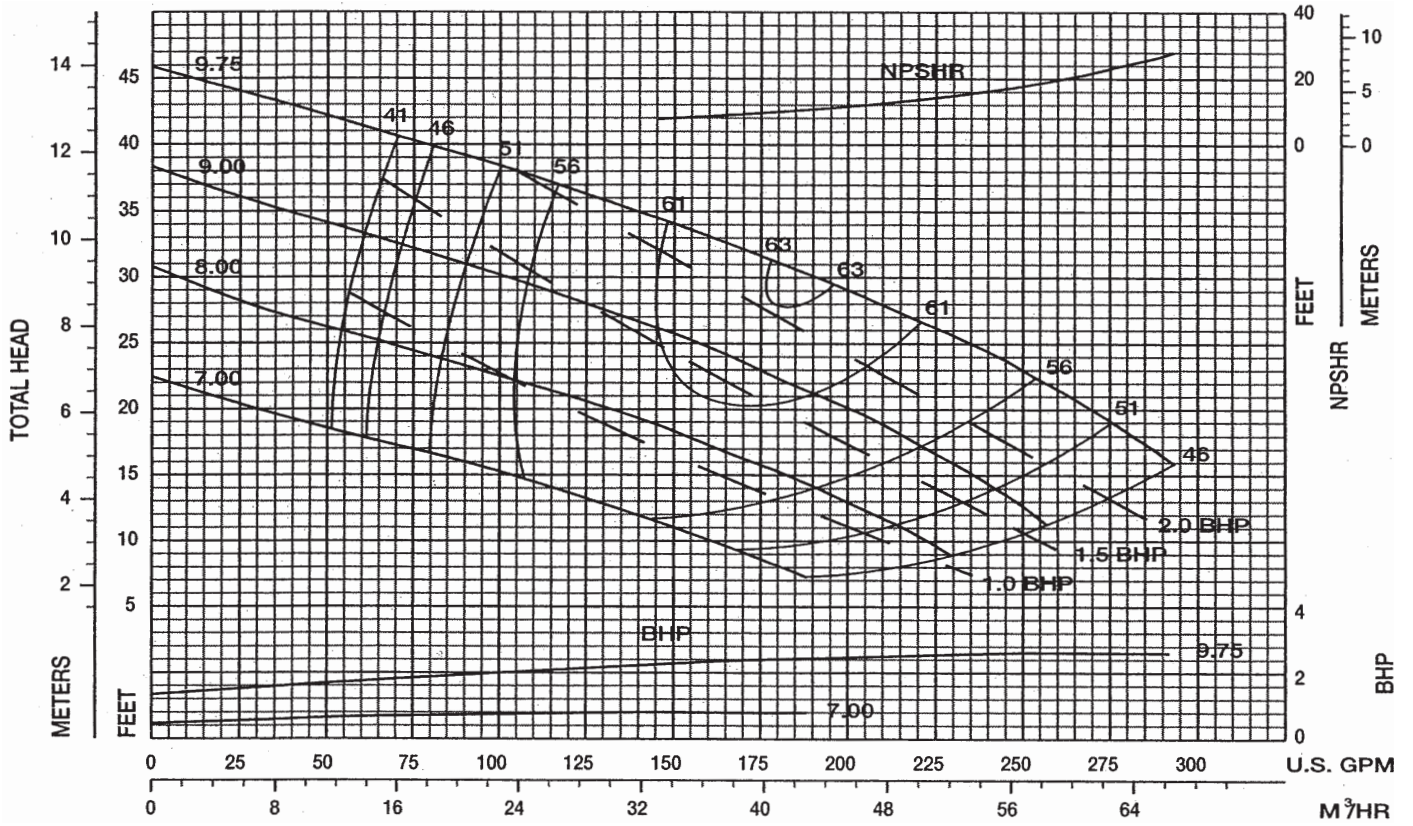

Performance Curve – 3" 5432 MT, MV, W, WD

RPM: 1155 SOLIDS: 2"

IMPELLER: T3B1A, 2 VANE SUCTION: 3" (WD: 3" or 4") INLET: 20.39 in²

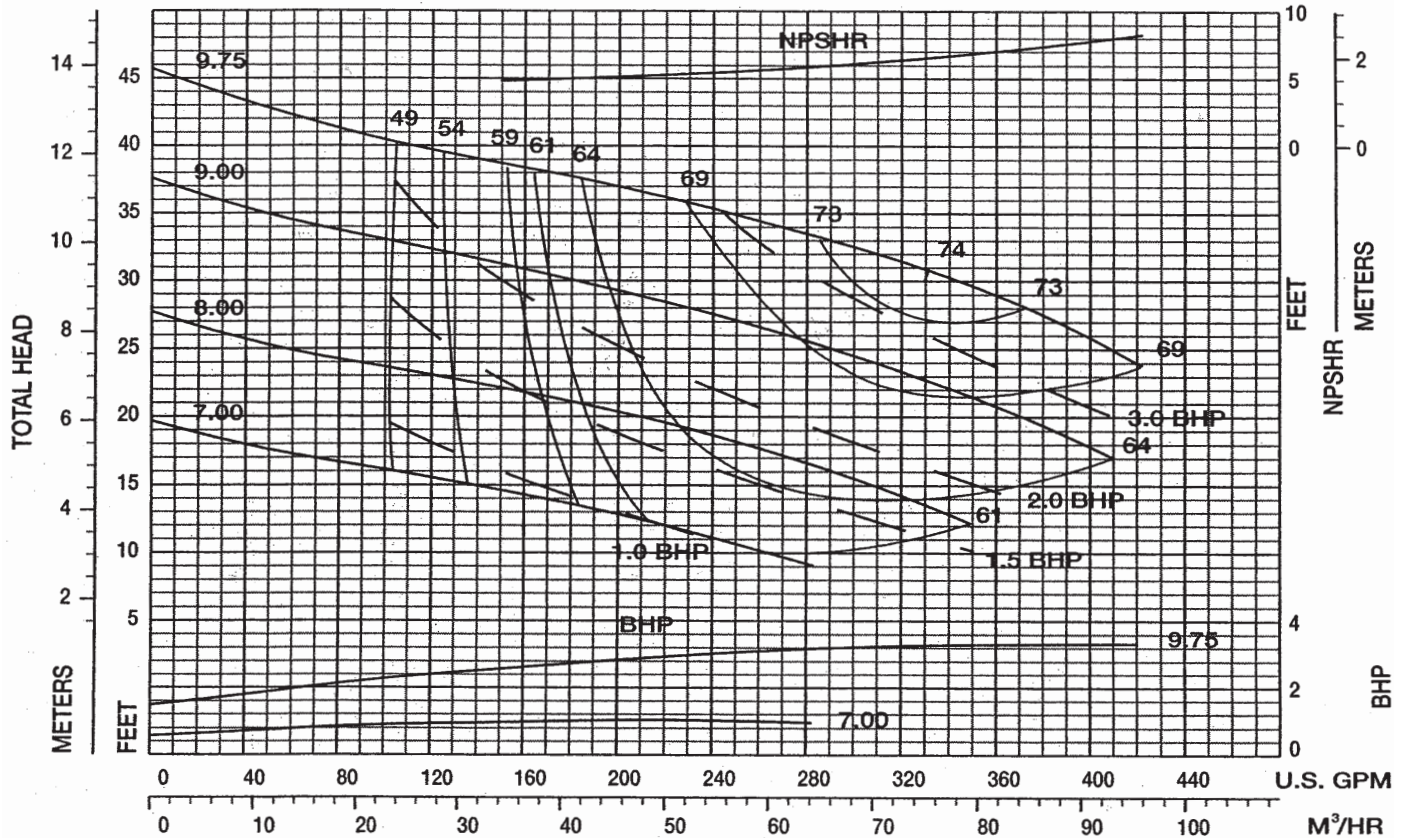

Performance Curve - 4" 5432 MTK, WK, WDK

RPM: 1155 SOLIDS: 3"

IMPELLER: T4B1AF, BLADELESS SUCTION: 4" (WDK: 4" or 6") INLET: 26.72 in²

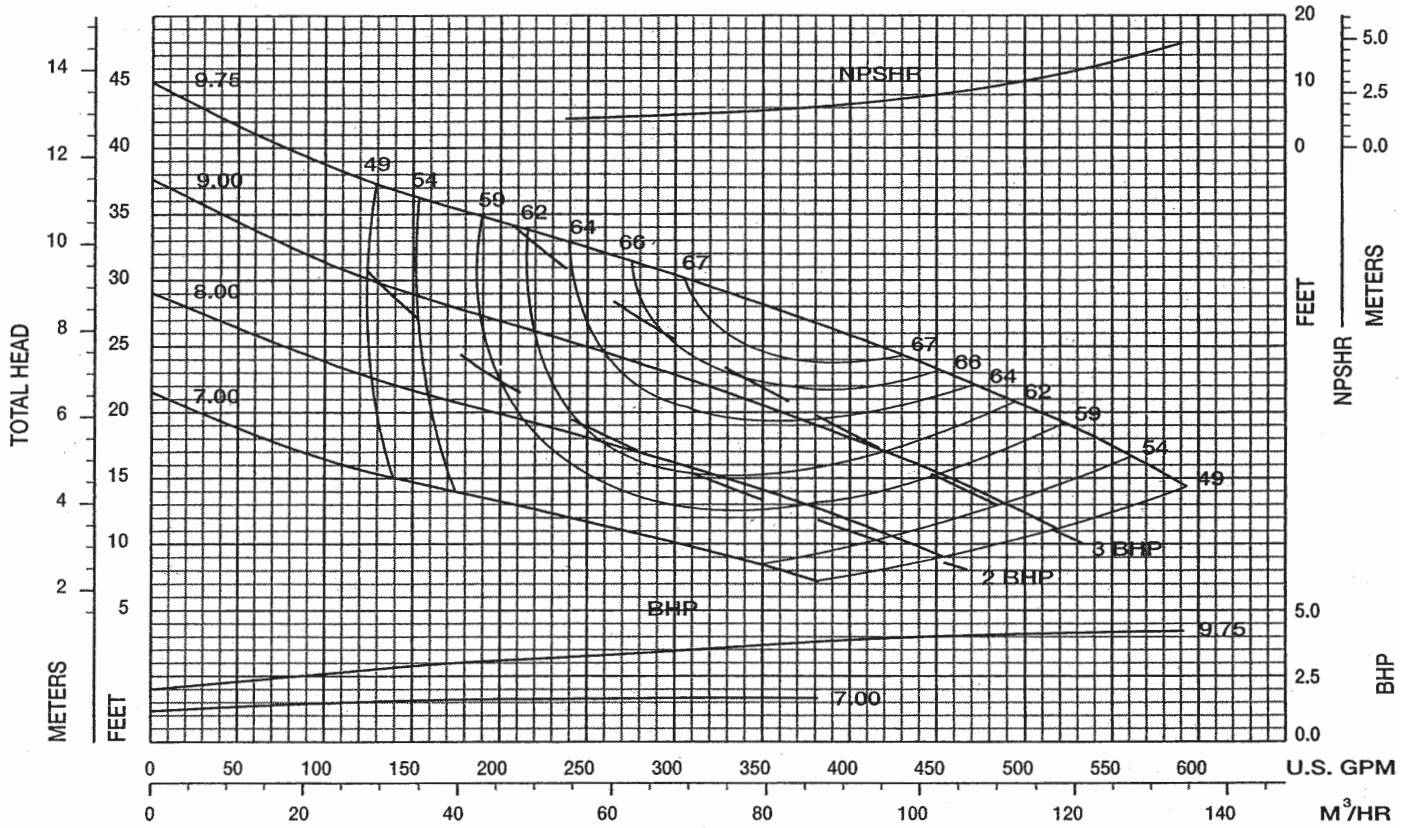

Performance Curve - 4" 5432 MT, W, WD, CWD

RPM: 1155 SOLIDS: 3"

IMPELLER: T4B1A, 2 VANE SUCTION: 4" (WD: 4" or 6") INLET: 26.22 in²

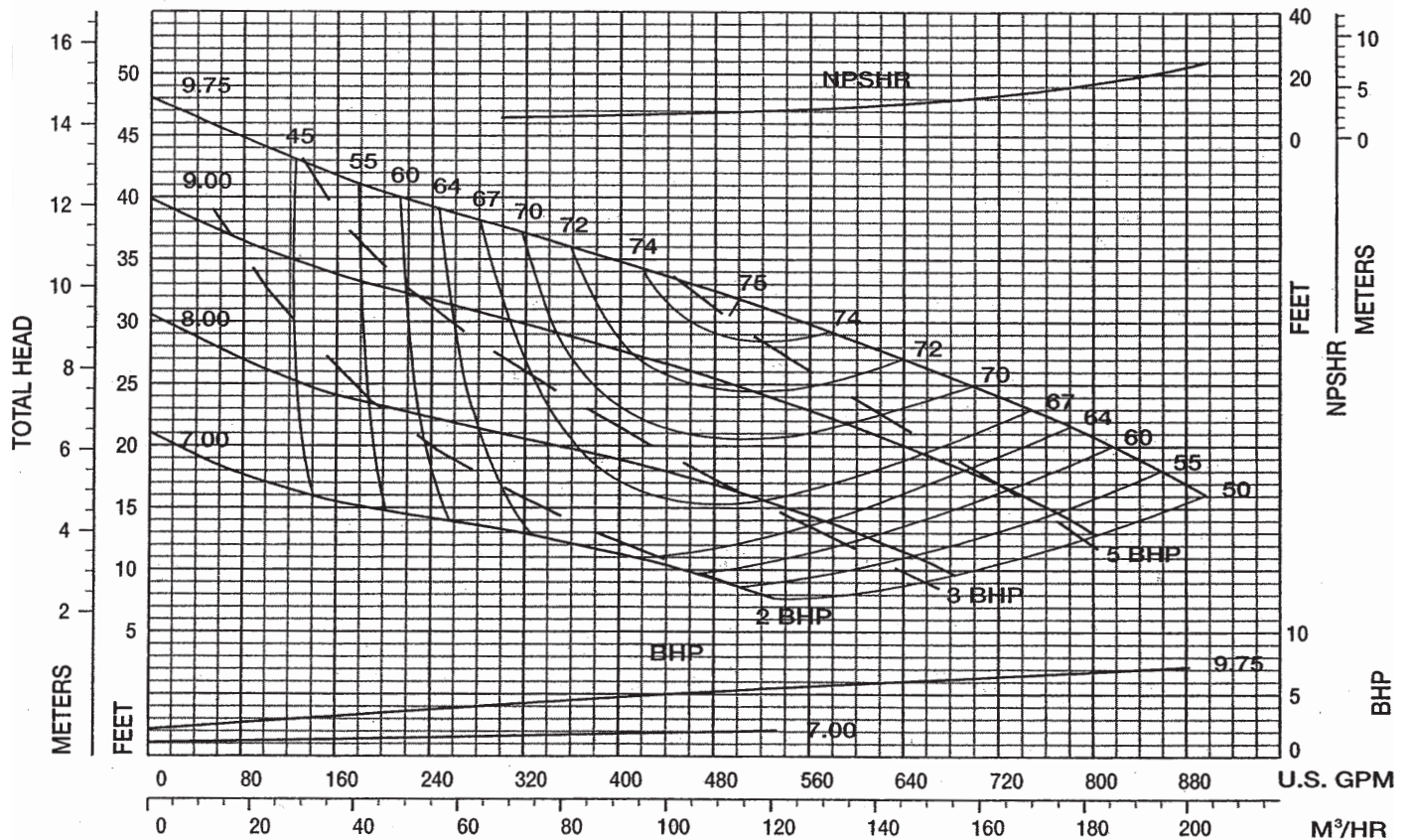

Performance Curve - 4" 5432 MVK

RPM: 1155 SOLIDS: 3"

IMPELLER: T4B1AF, BLADELESS SUCTION: 4" INLET: 26.72 in²

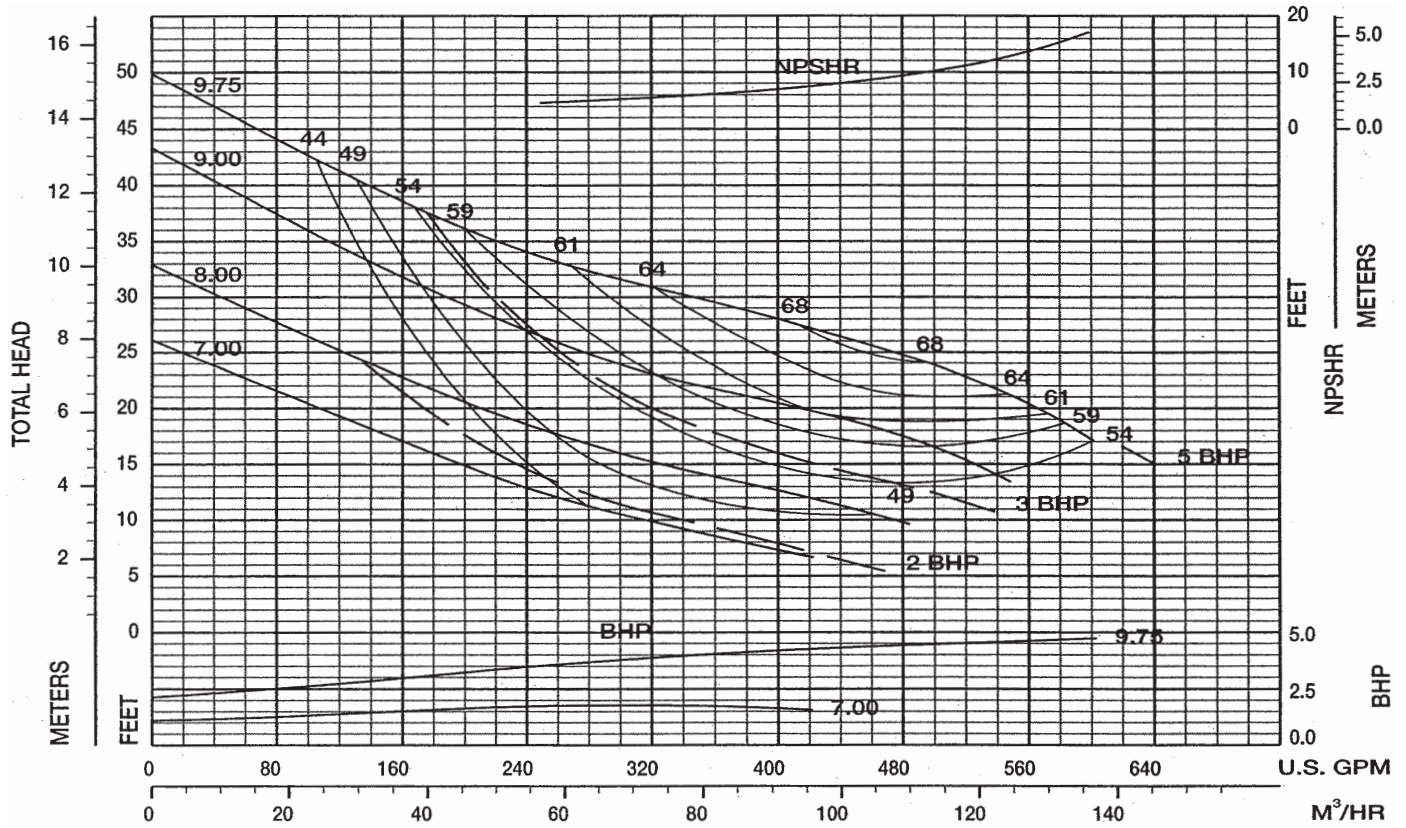

Performance Curve - 4" 5432 MV

RPM: 1170 SOLIDS: 3"

IMPELLER: T4B1A, 2 VANE SUCTION: 4" INLET: 26.22 in²

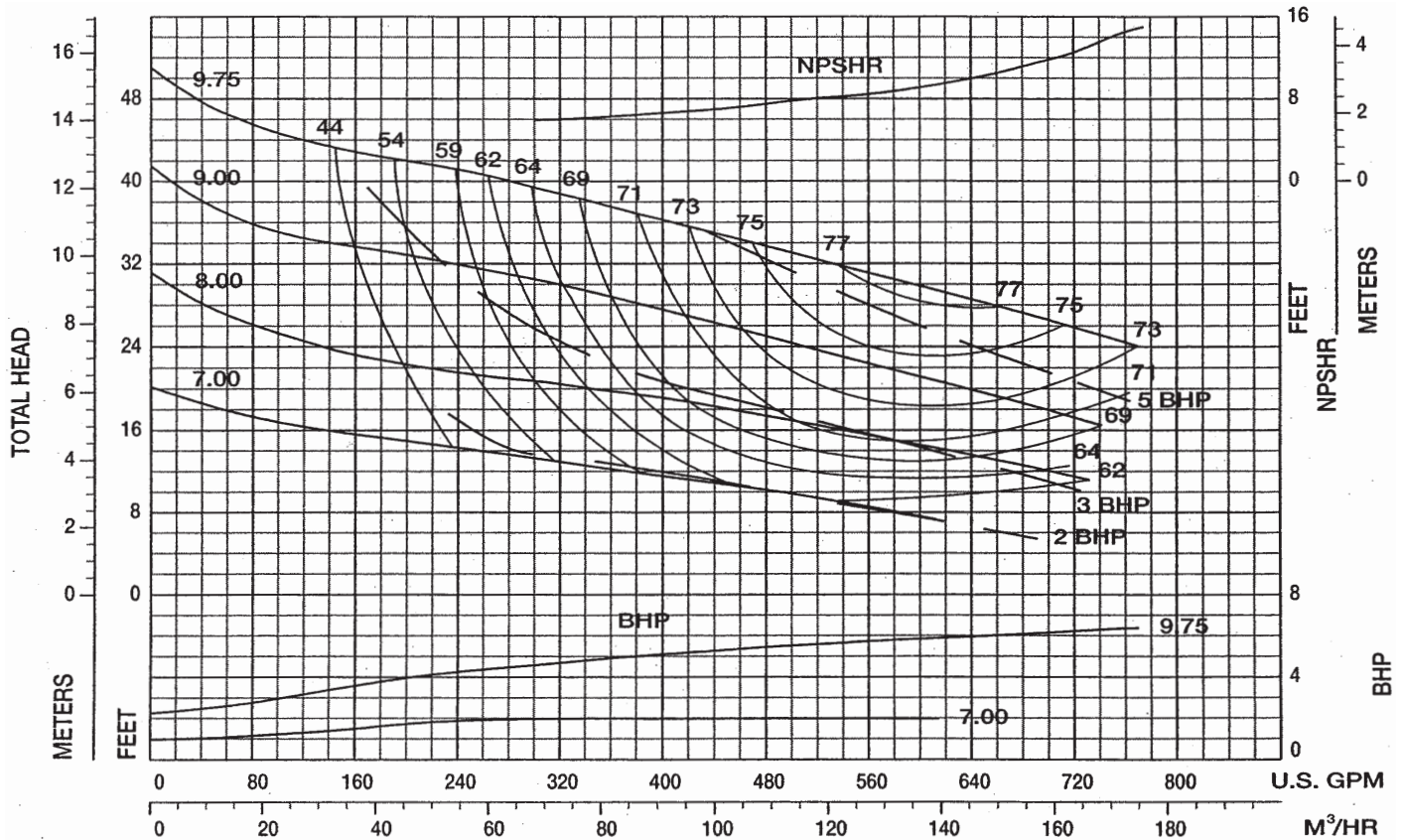

Performance Curve – 3" 5433 MTK, MVK, WK, WDK

RPM: 1150 SOLIDS: 2"

IMPELLER: T3C1T, BLADELESS SUCTION: 3" (WDK: 3" or 4") INLET: 11.77 in²

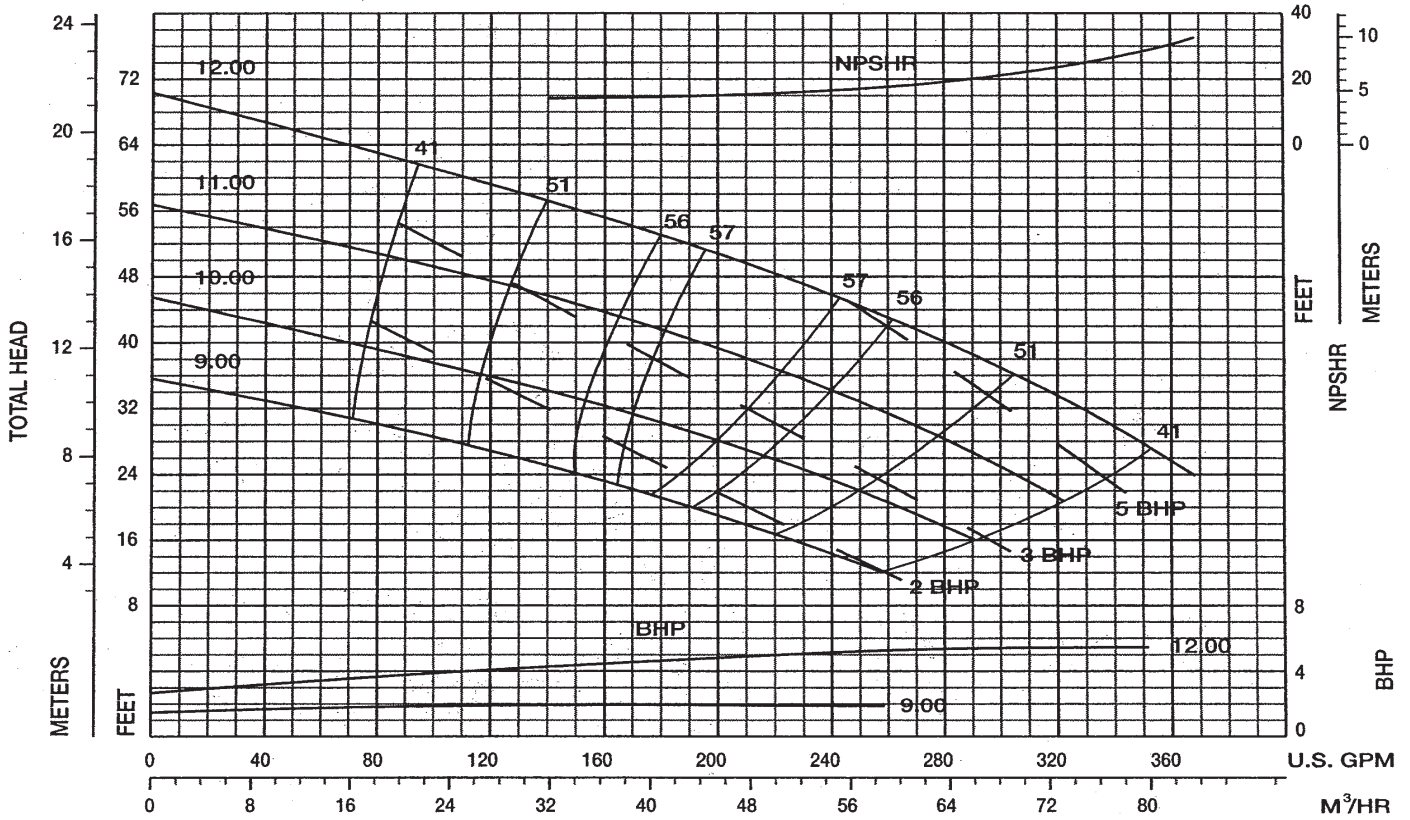

Performance Curve – 3" 5433 MT, MV, W, WD

RPM: 1155 SOLIDS: 2"

IMPELLER: T3C1A, 2 VANE SUCTION: 3" (WD: 3" or 4") INLET: 23.52 in²

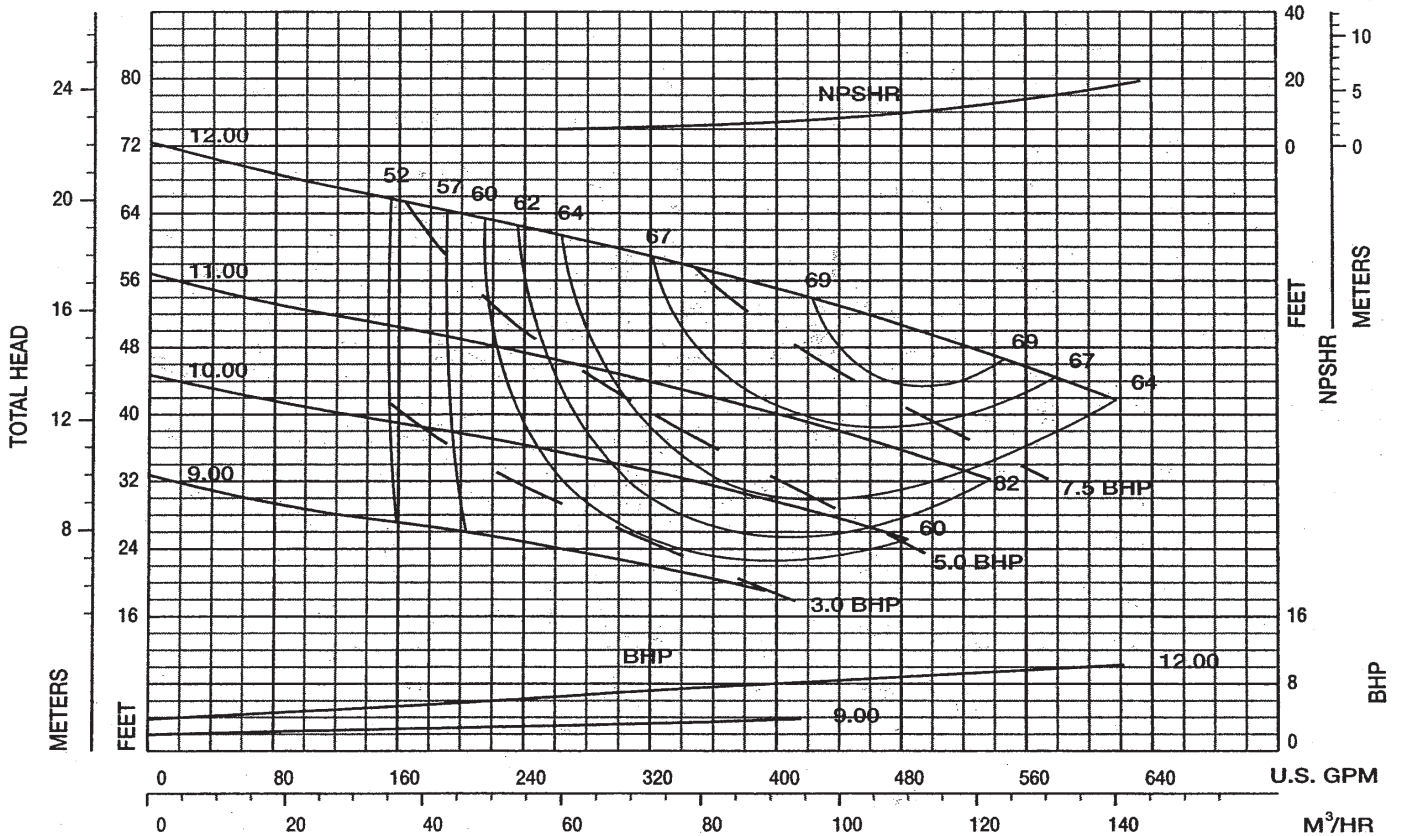

Performance Curve – 4" 5433 MTK, WK, WDK, CWDK

RPM: 1155 SOLIDS: 3"

IMPELLER: T4C1AA, BLADELESS SUCTION: 4" (WDK: 4" or 6") INLET: 23.77 in²

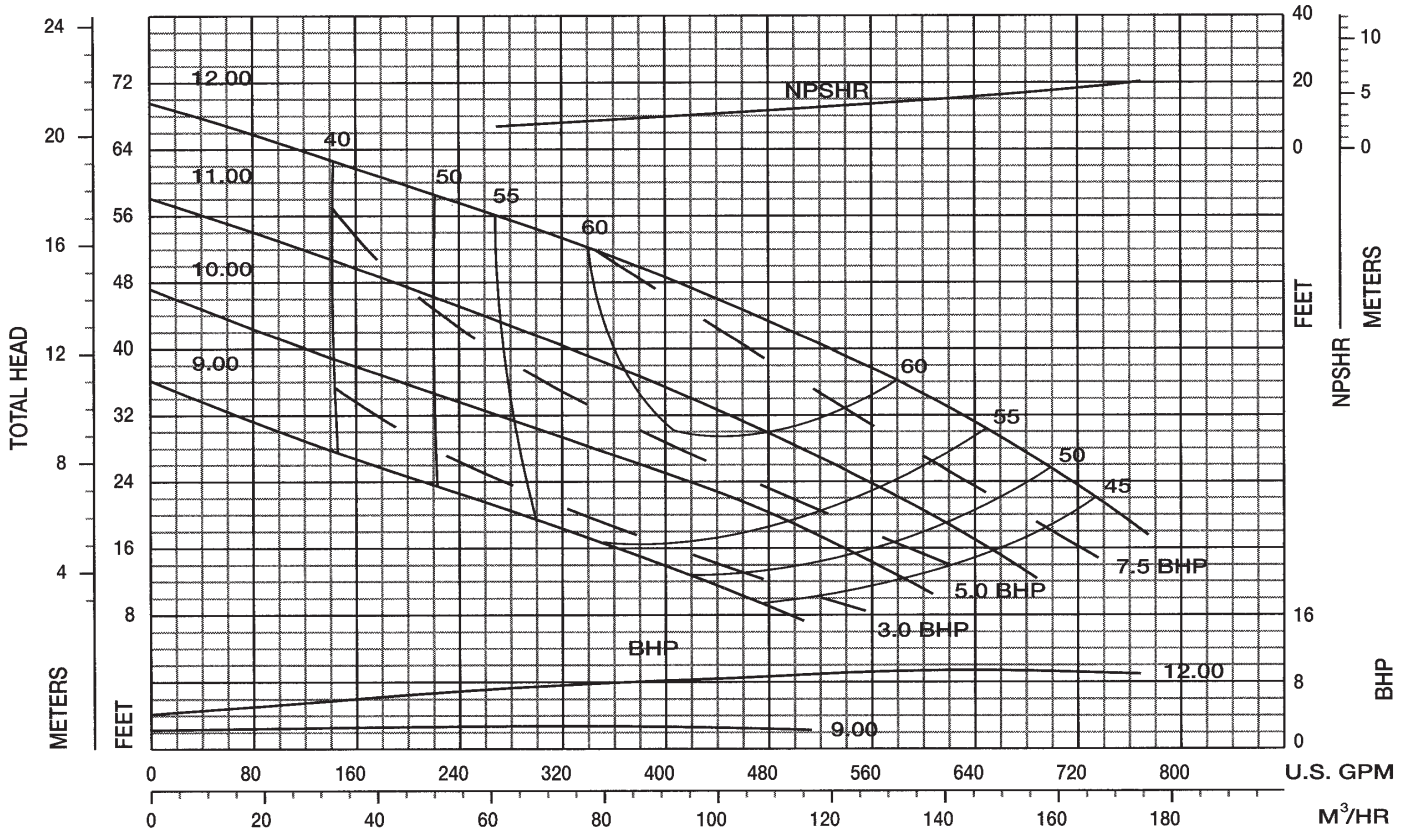

Performance Curve – 4" 5433 MT, W, WD, CWD

RPM: 1155 SOLIDS: 3"

IMPELLER: T4C1A, 2 VANE SUCTION: 4" (WD: 4" or 6") INLET: 37.50 in²

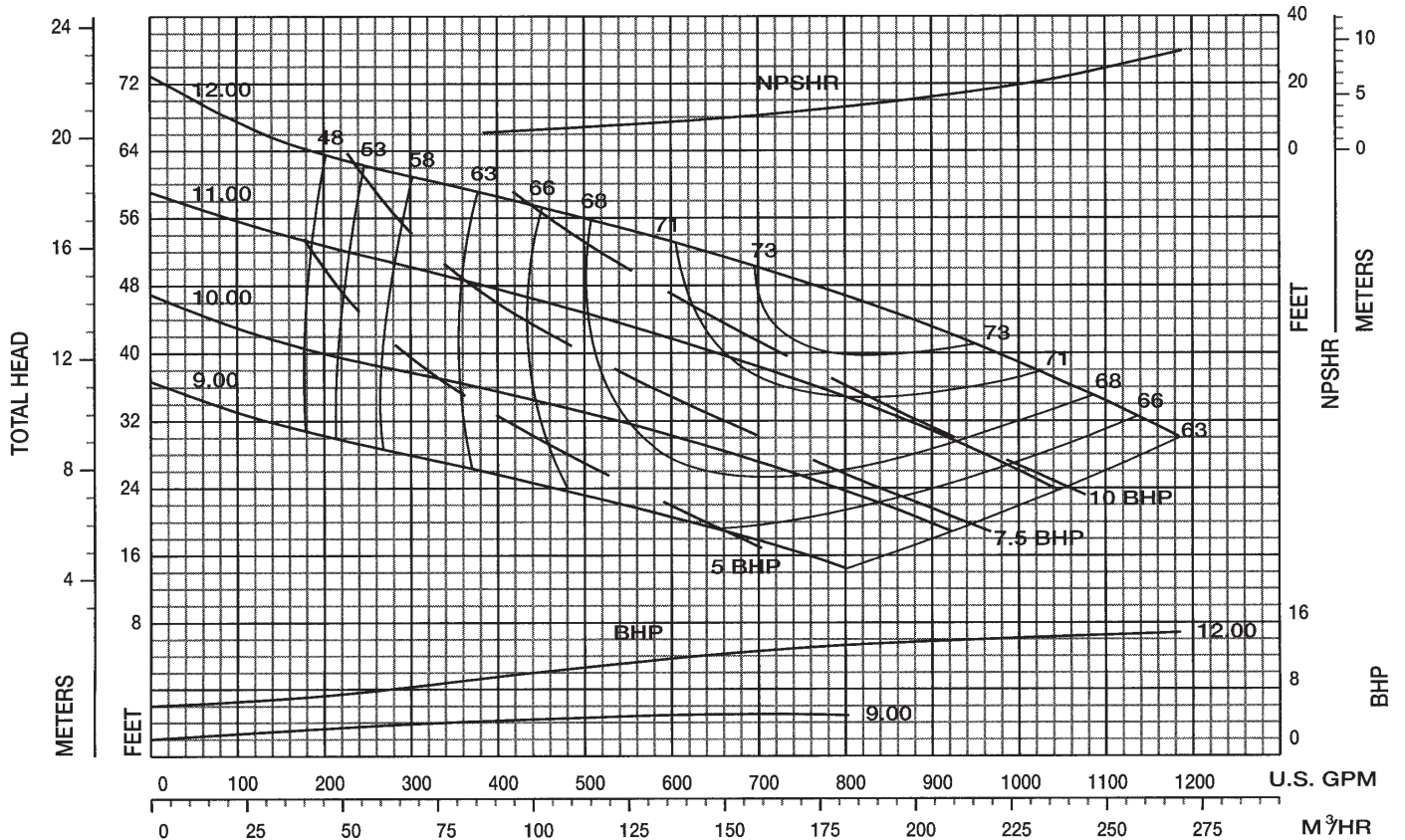

Performance Curve - 4" 5433 MVK

RPM: 1170 SOLIDS: 3"

IMPELLER: T4C1AA, BLADELESS SUCTION: 4" INLET: 23.77 in²

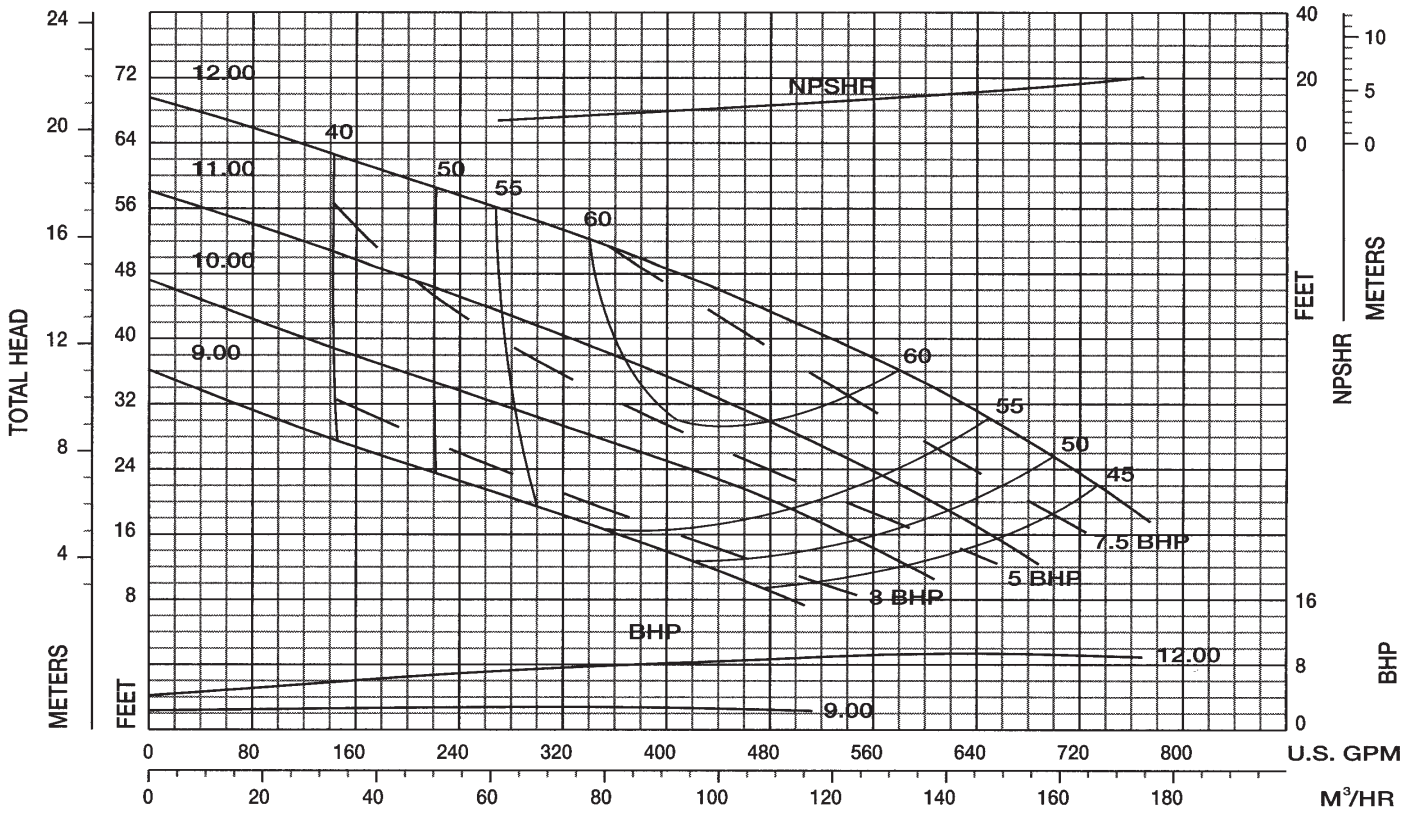

Performance Curve - 4" 5433 MV

RPM: 1155 SOLIDS: 3"

IMPELLER: T4C1A, 2 VANE SUCTION: 4" INLET: 26.22 in²

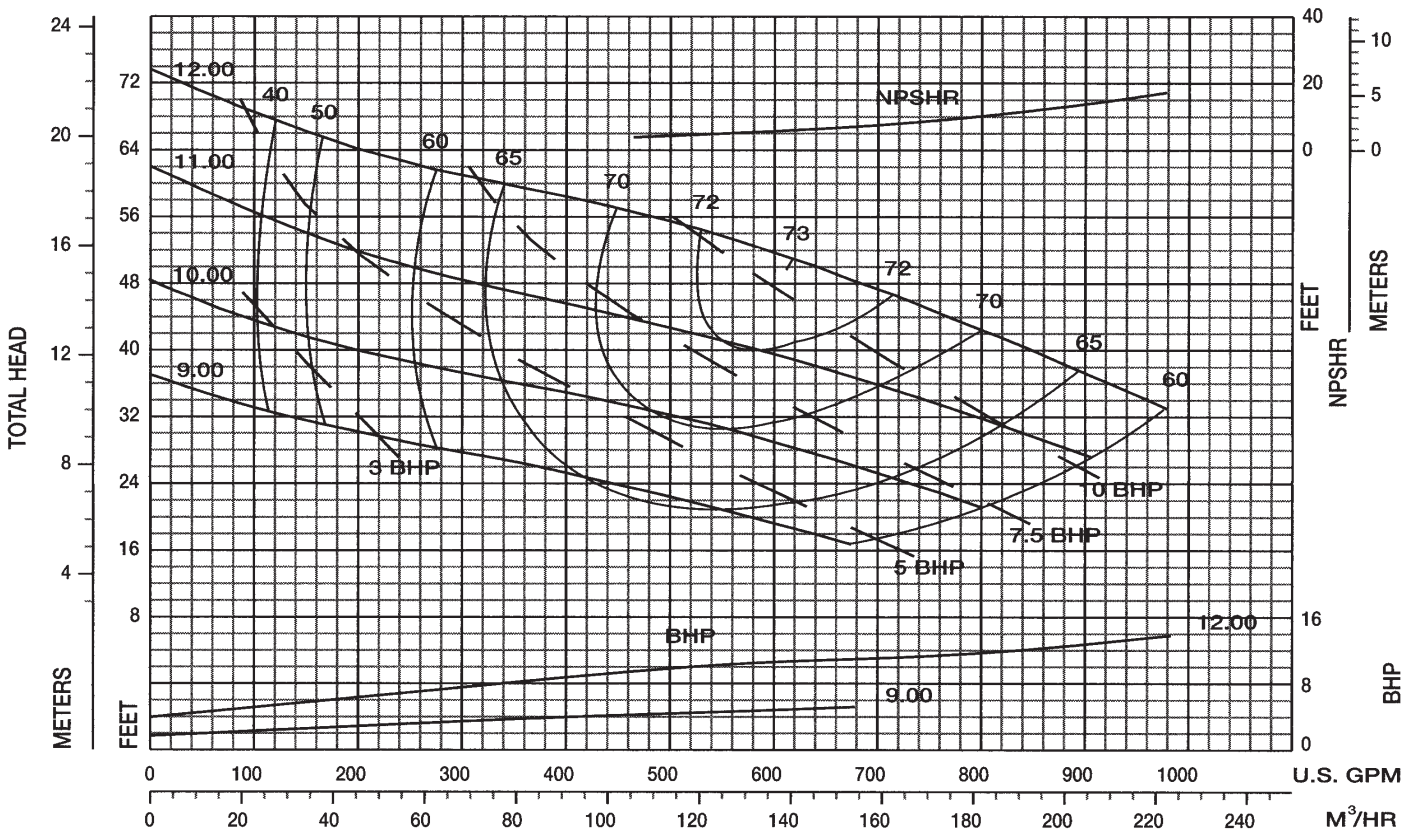

Performance Curve – 4" 5433 MV

RPM: 1155 SOLIDS: 3"

IMPELLER: T4C1NA, 2 VANE SUCTION: 4" INLET: 26.22 in²

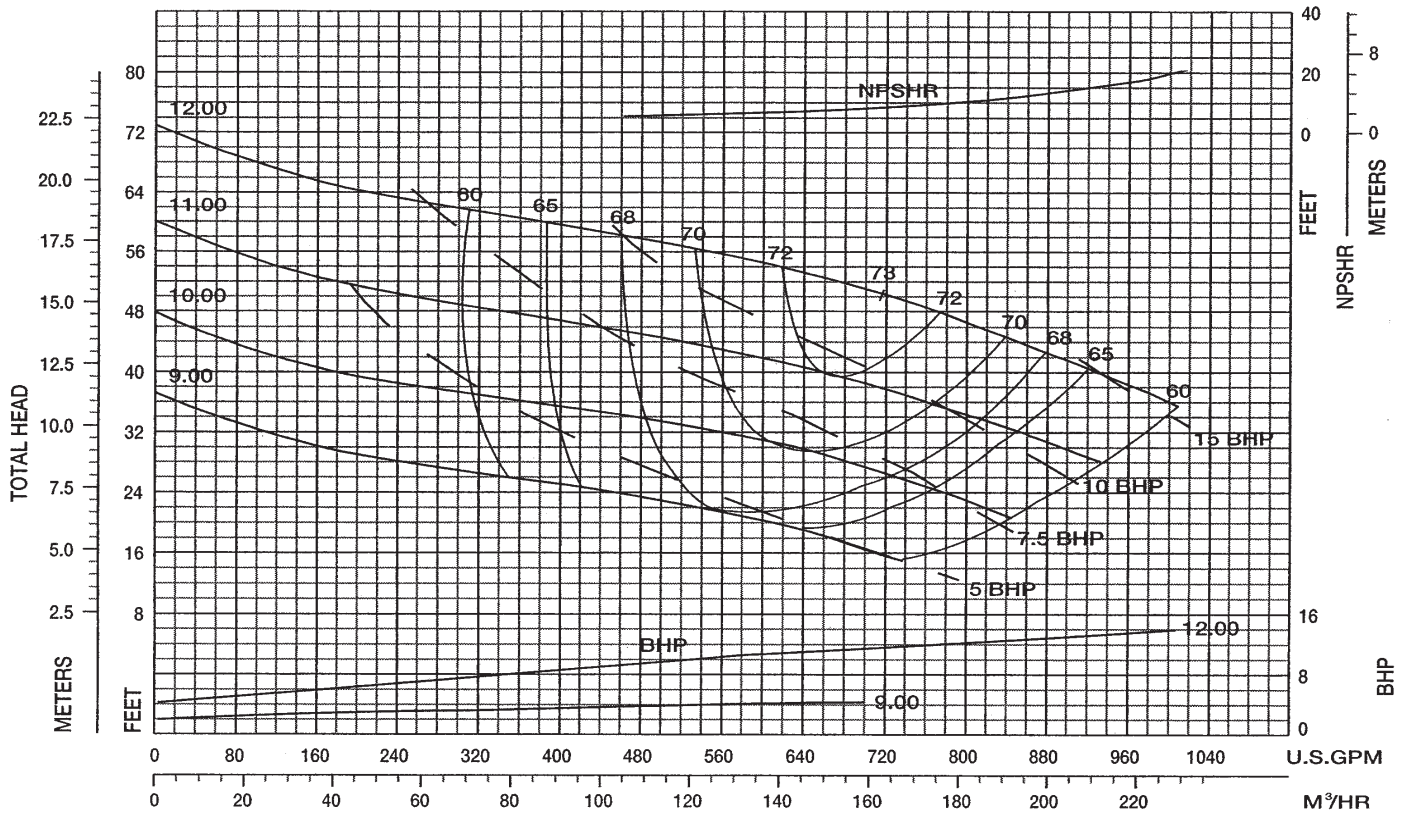

Performance Curve – 5" 5433 MVK, MTK, WK, WDK

RPM: 1155 SOLIDS: 3-1/2"

IMPELLER: T5C1AG, BLADELESS SUCTION: 5" (WDK: 5" or 6") INLET: 37.69 in²

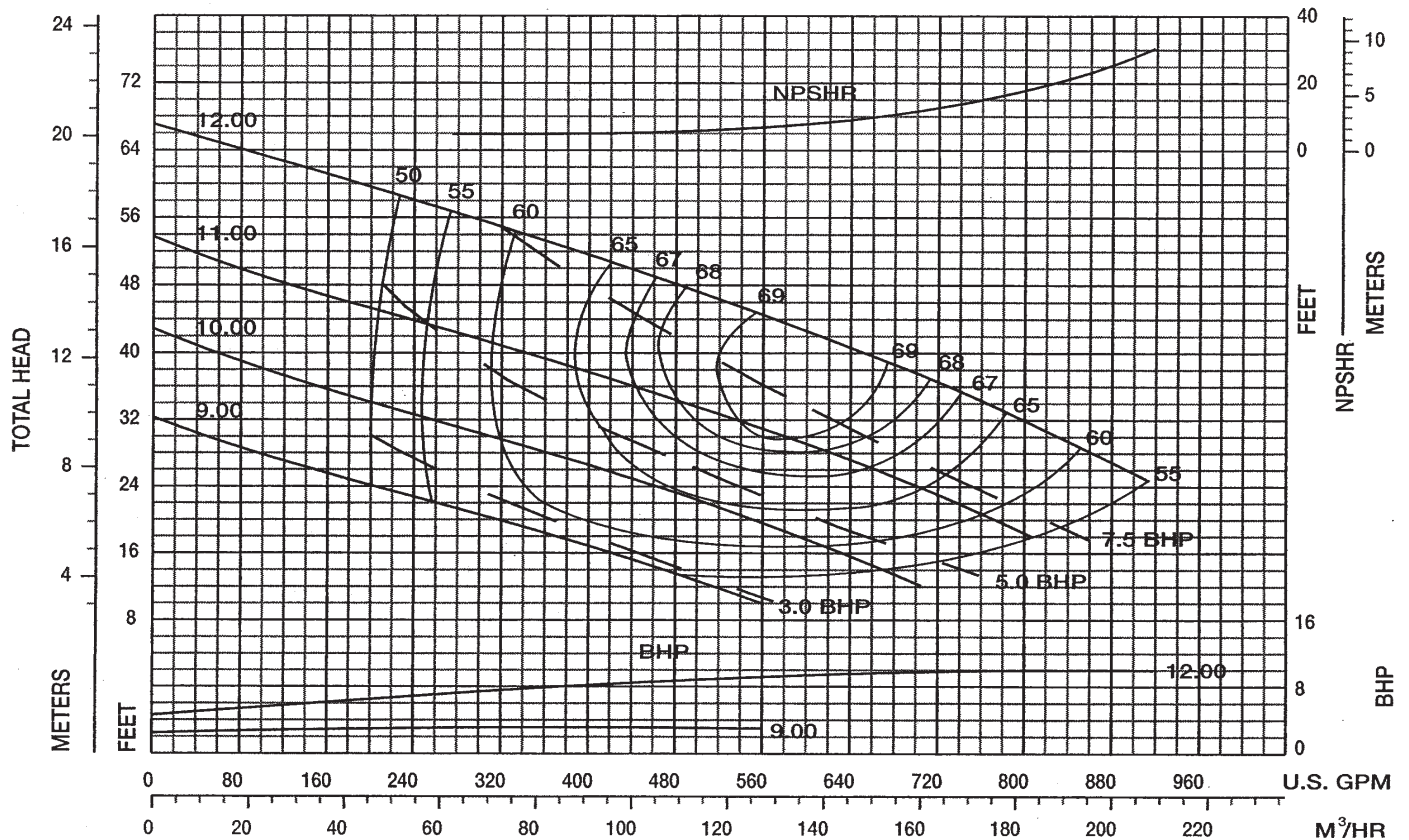

Performance Curve - 5" 5433 MT, W, WD

RPM: 1155 SOLIDS: 3-1/2"

IMPELLER: T5C1A, 2 VANE SUCTION: 5" (WD: 5", 6" or 8") INLET: 46.43 in²

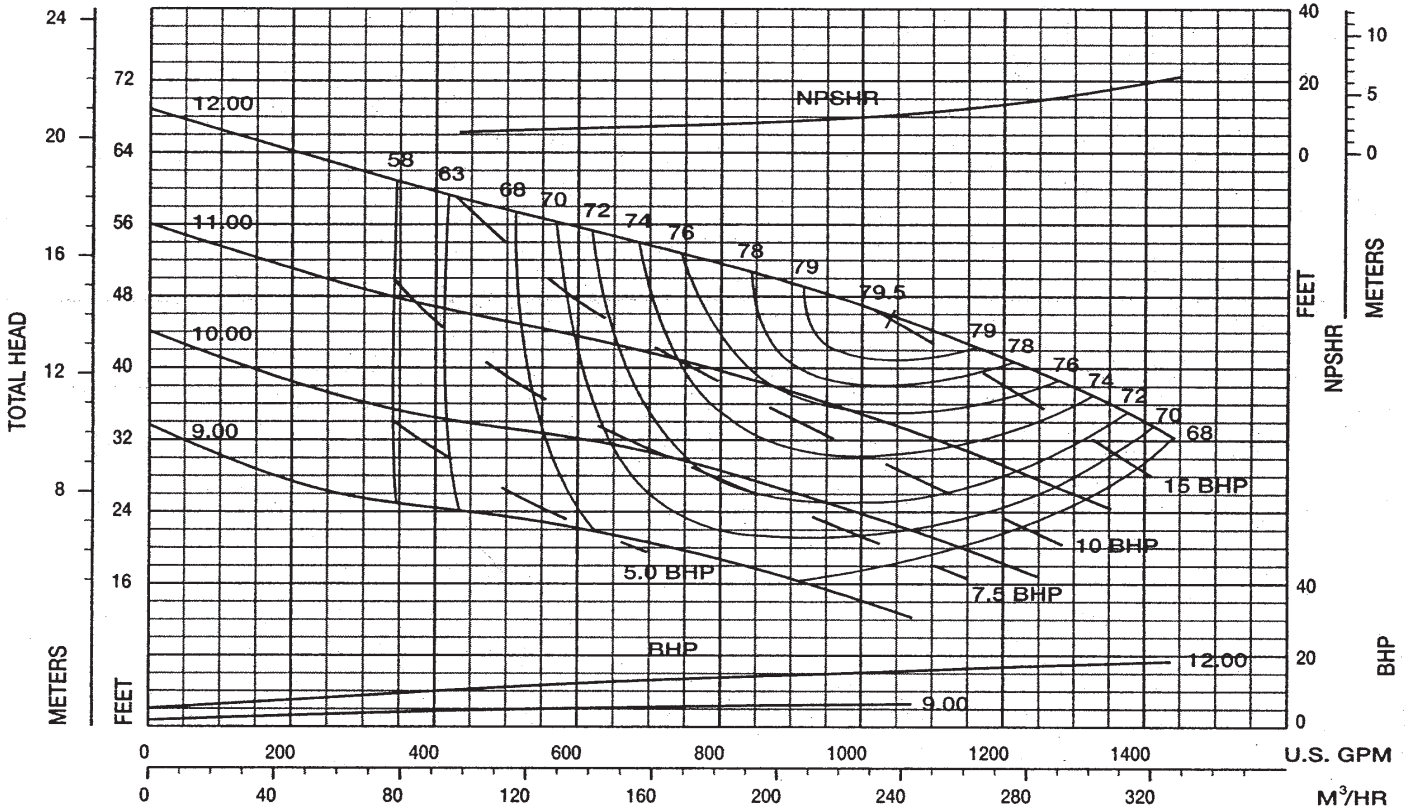

Performance Curve - 6" 5433 MT, W, WD

RPM: 1155 SOLIDS: 3"

IMPELLER: T6C1C, 2 VANE SUCTION: 8" (WD: 6" or 8") INLET: 52.88 in²

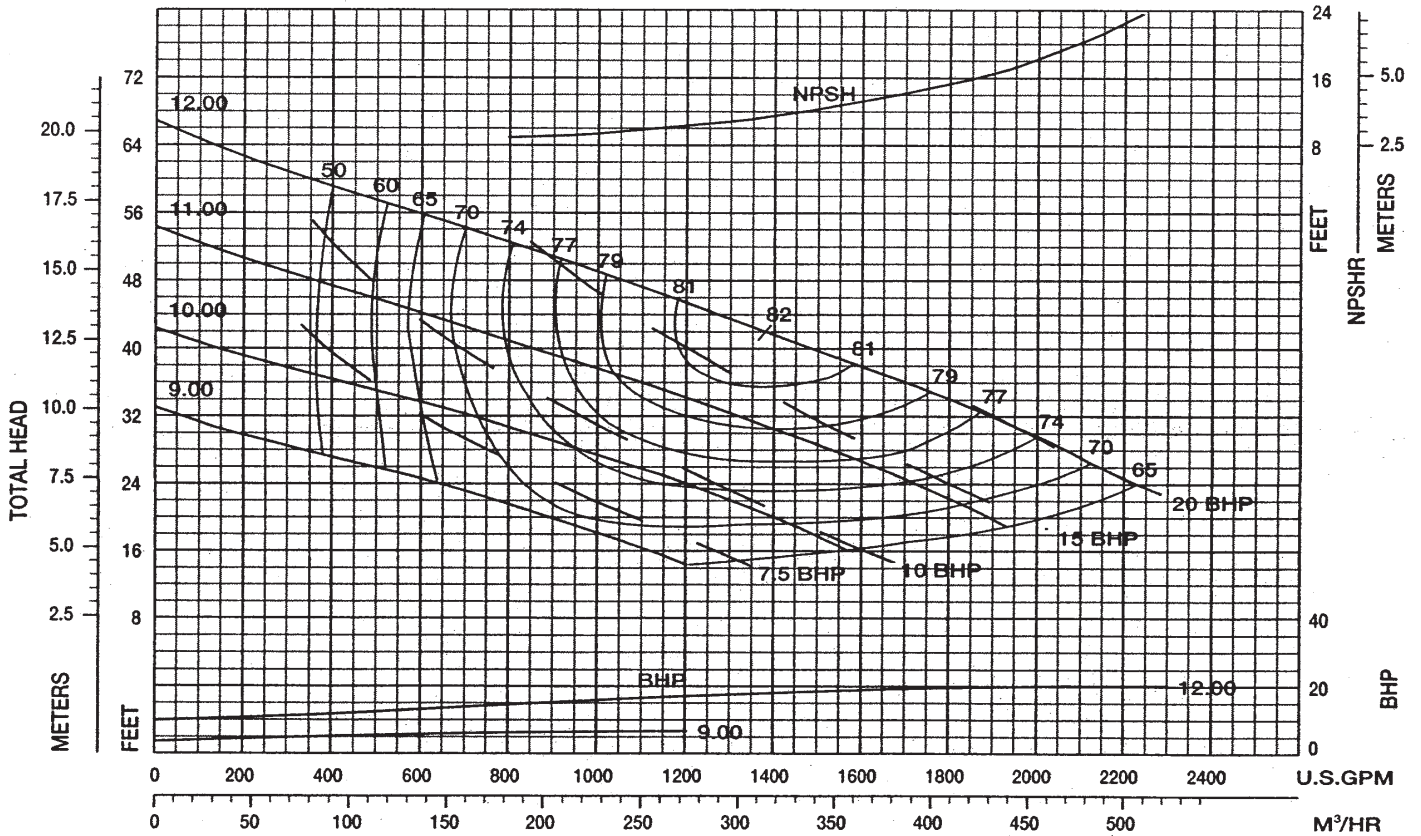

Performance Curve – 6" 5433 MV

RPM: 1155 SOLIDS: 3"

IMPELLER: T6C1C, 2 VANE SUCTION: 6" INLET: 52.88 in²

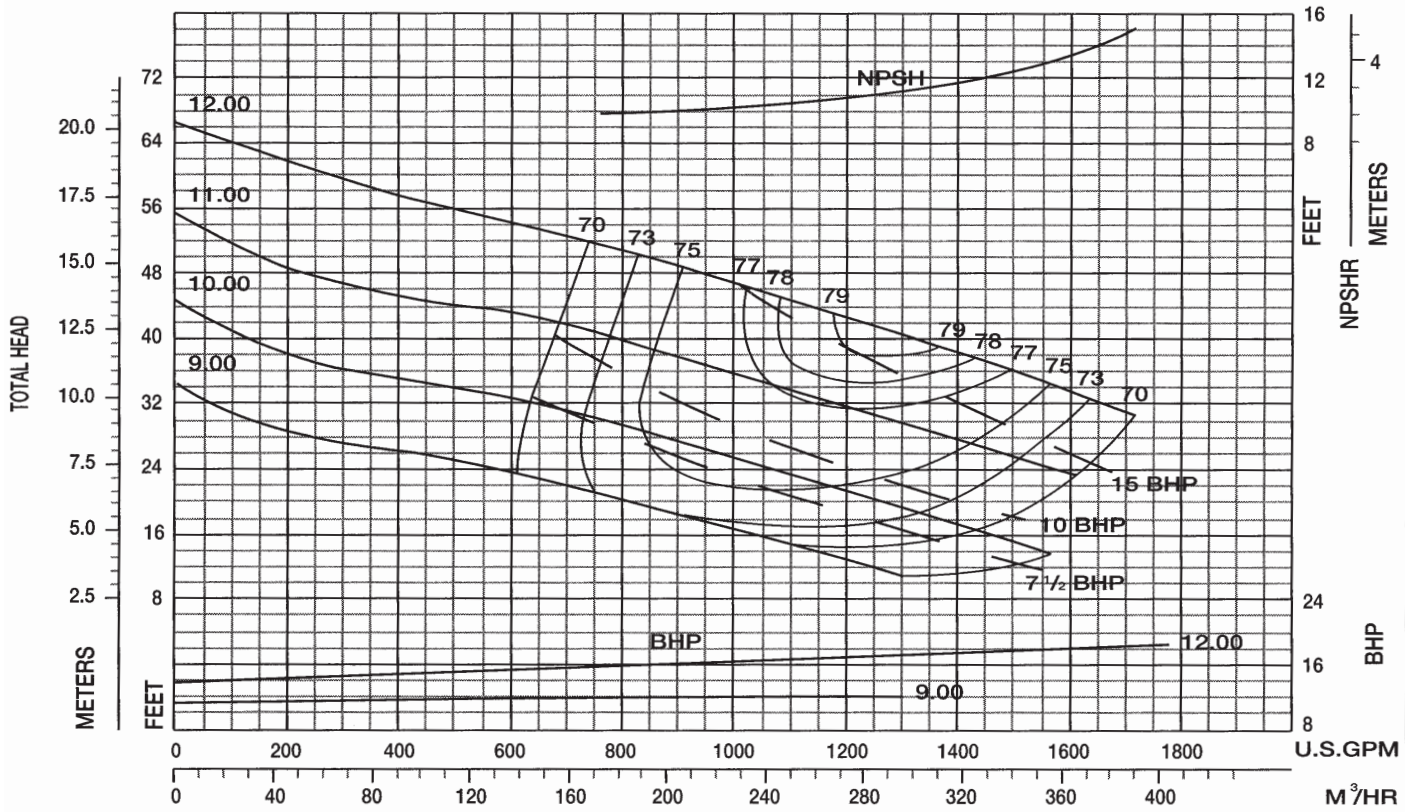

Performance Curve – 4" 5434 MT, W, WD

RPM: 1185 SOLIDS: 3"

IMPELLER: T4D1B, 2 VANE SUCTION: 5" (WD: 5", 6" or 8") INLET: 47.01 in²

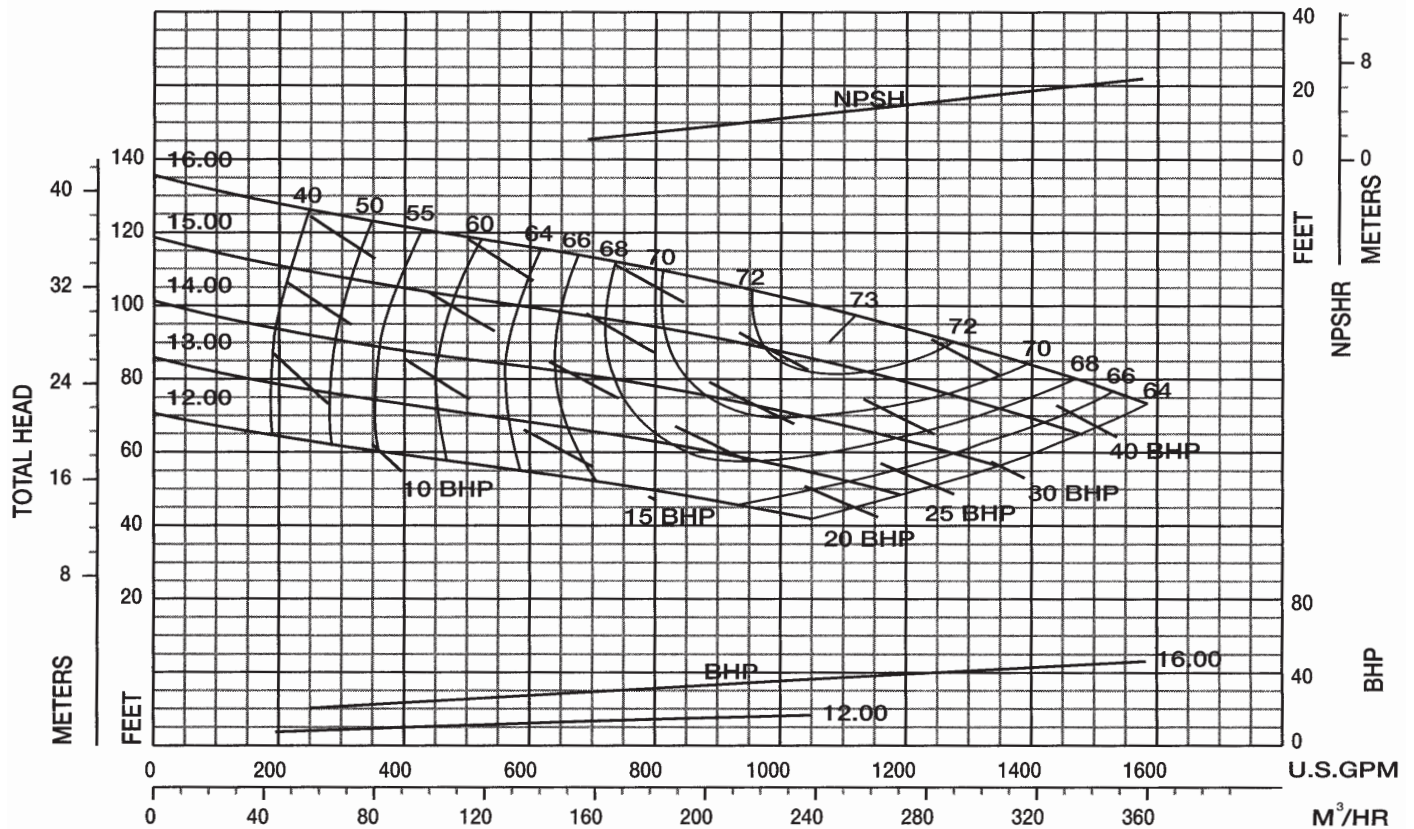

Performance Curve – 4" 5434 MV

RPM: 1180 SOLIDS: 3"

IMPELLER: T4D1B, 2 VANE SUCTION: 4" INLET: 47.01 in²

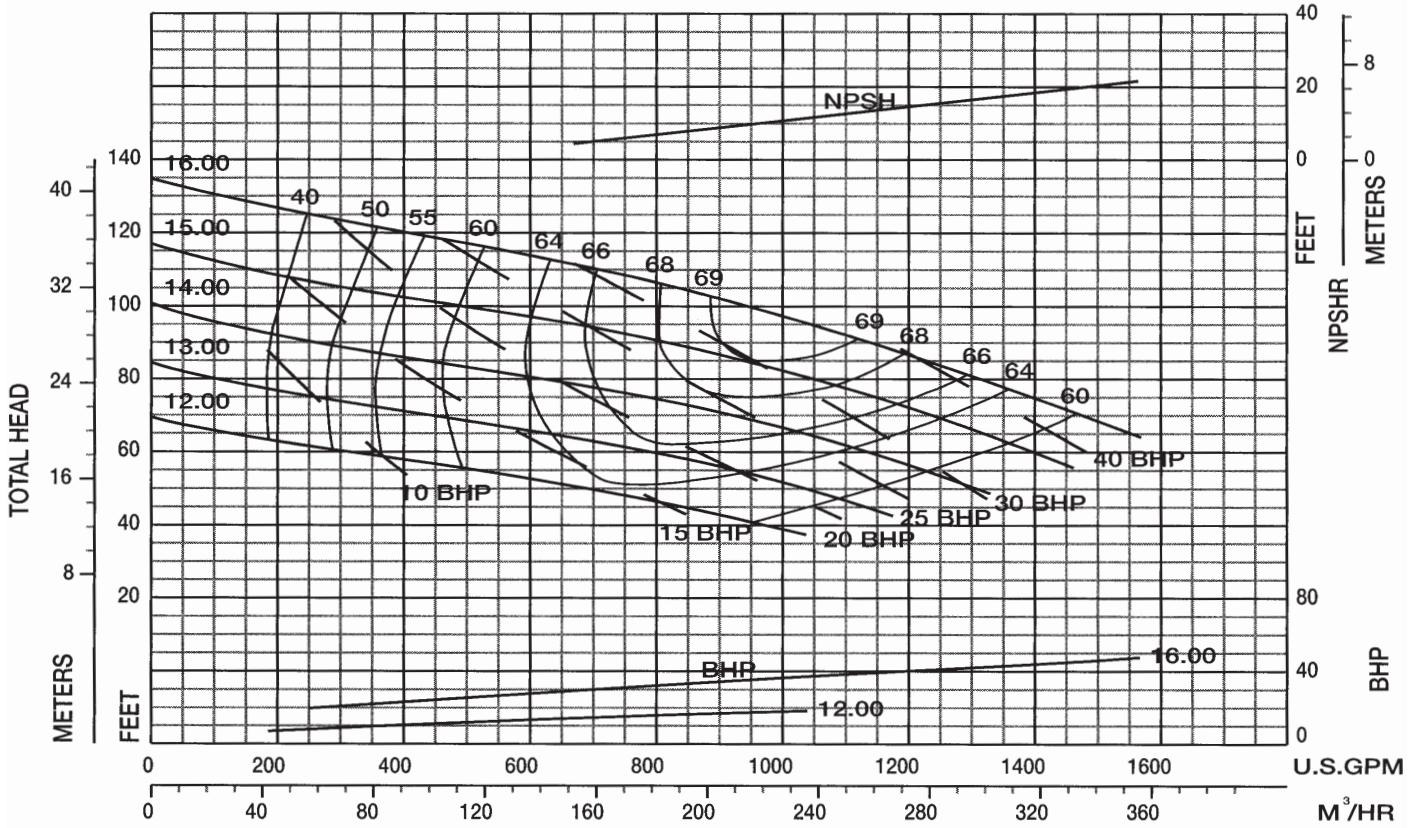

Performance Curve – 5" 5434 MT, W, WD

RPM: 1180 SOLIDS: 4"

IMPELLER: T5D1A, 2 VANE SUCTION: 6" (WD: 6" or 8") INLET: 58.39 in²

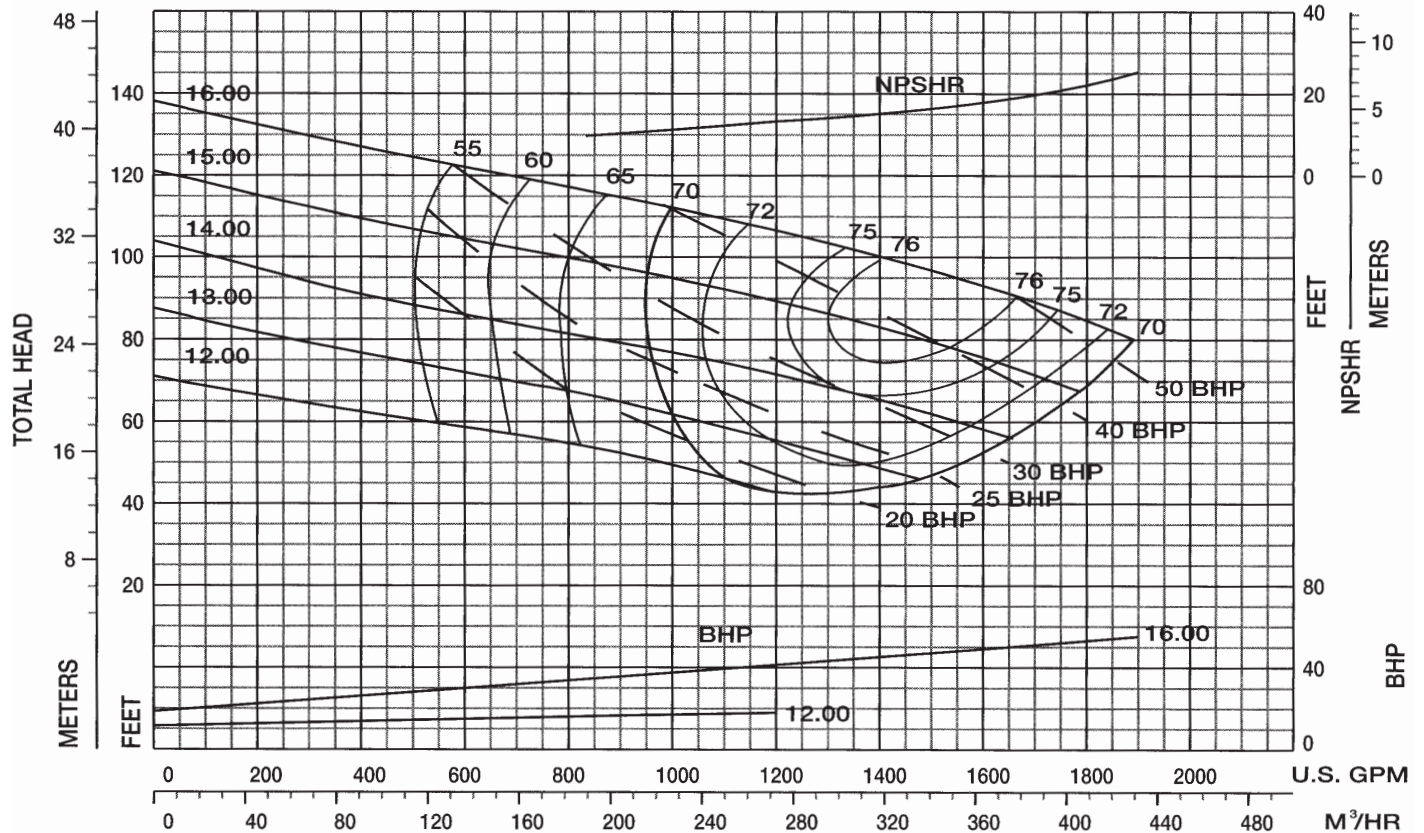

Performance Curve – 6" 5434 MTK, WK, WDK

RPM: 1180 SOLIDS: 4"

IMPELLER: T6D1A, BLADELESS SUCTION: 6" (WDK: 6" or 8") INLET: 36.42 in²

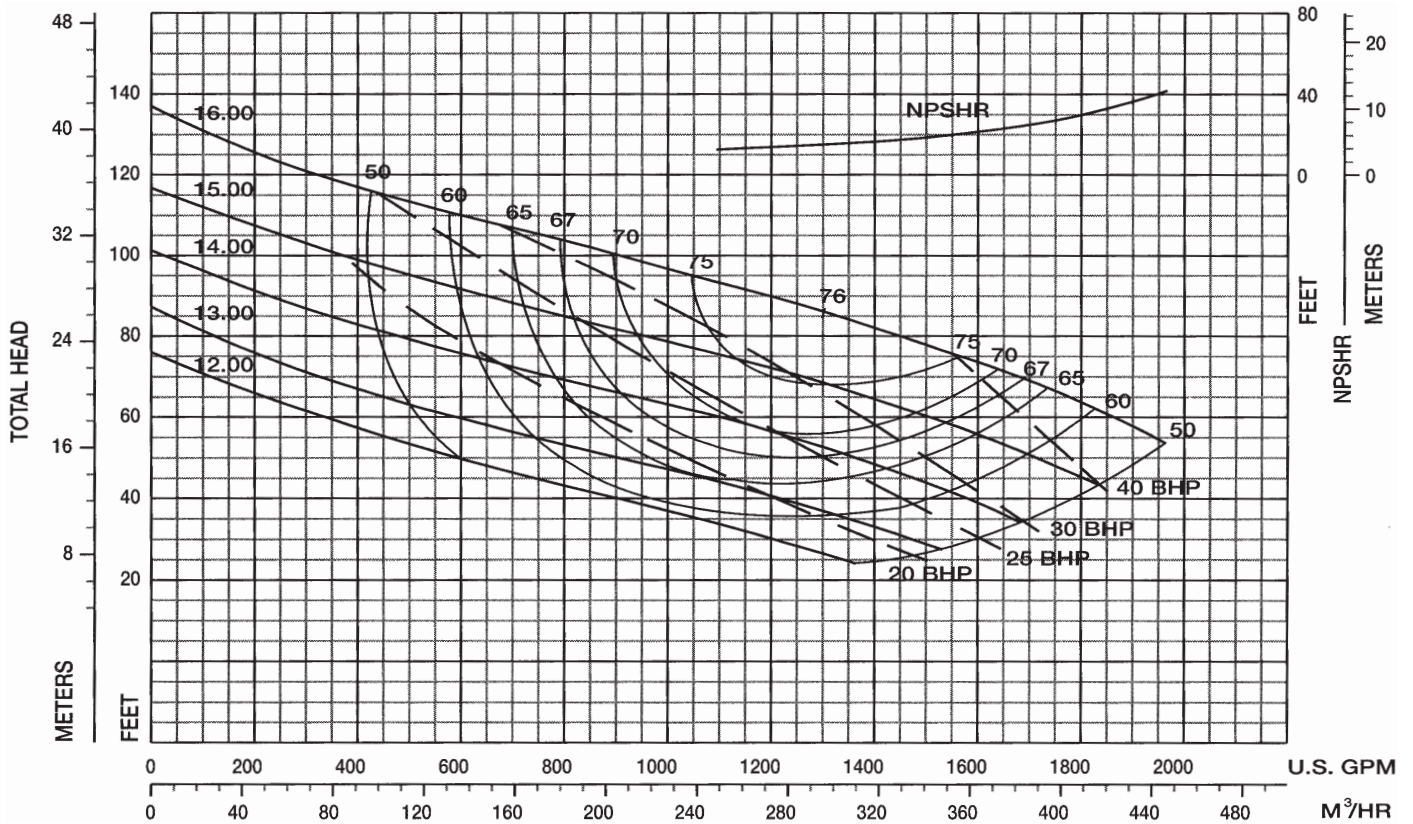

Performance Curve – 6" 5434 MT, W, WD

RPM: 1175 SOLIDS: 3"

IMPELLER: TAJC5BH, 3 VANE SUCTION: 6" (WD: 6" or 8") INLET: 60.58 in²

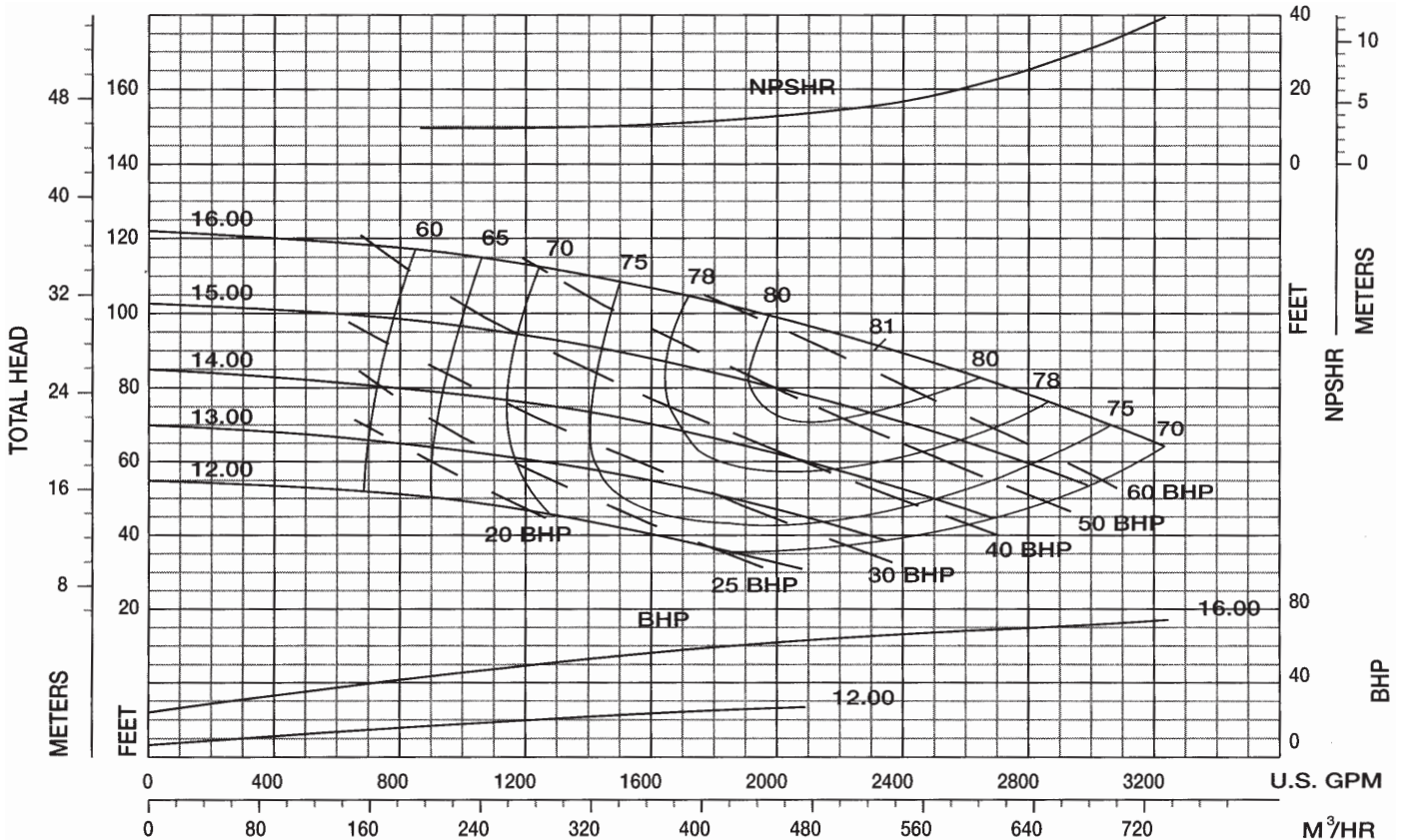

Performance Curve – 6" 5434 MT, W, WD

RPM: 1175 SOLIDS: 4"

IMPELLER: TAJC5DC, 2 VANE SUCTION: 6" (WD: 6" or 8") INLET: 70.85 in²

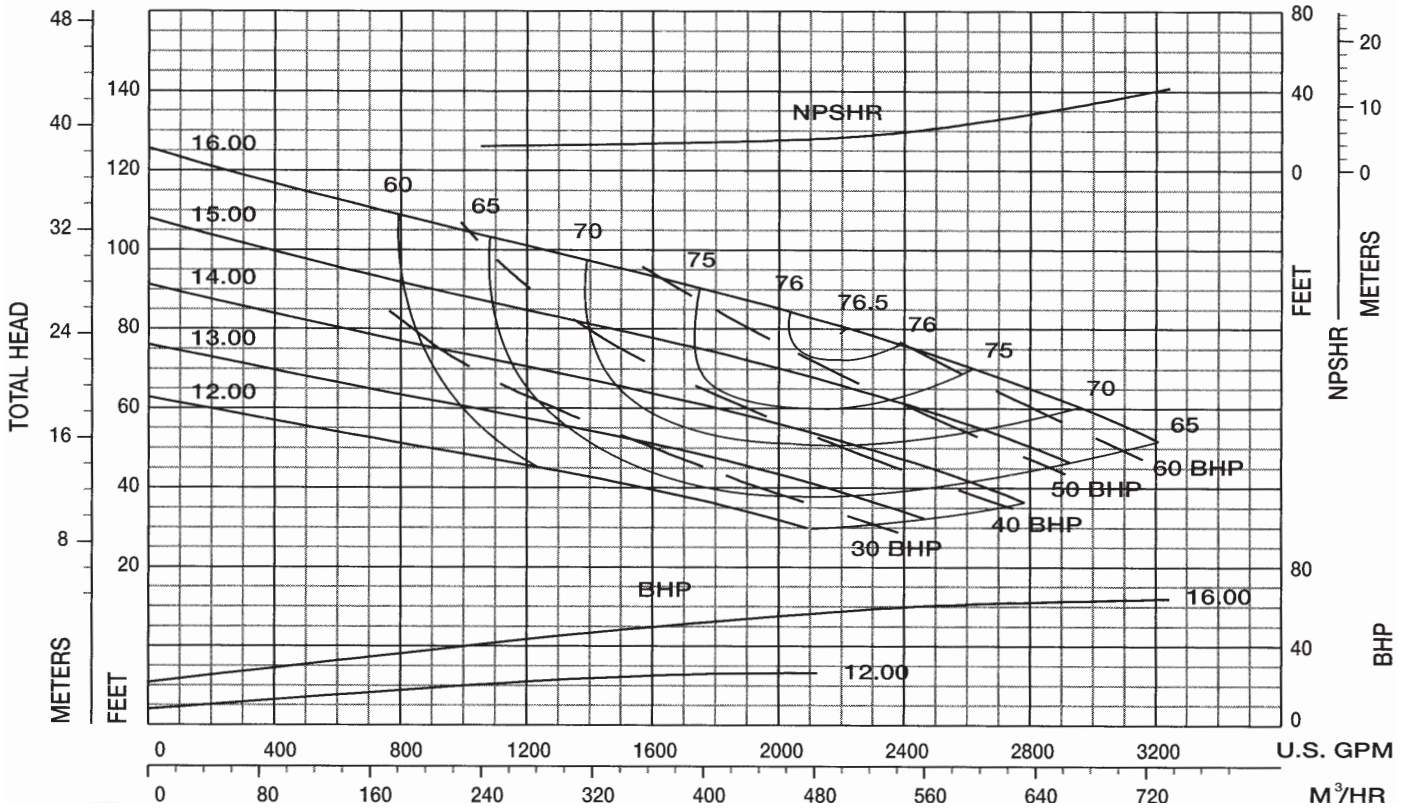

Performance Curve – 6" 5434 MT, W, WD

RPM: 1180 SOLIDS: 3"

IMPELLER: TAJC5BJ, 3 VANE SUCTION: 6" (WD: 6" or 8") INLET: 64.55 in²

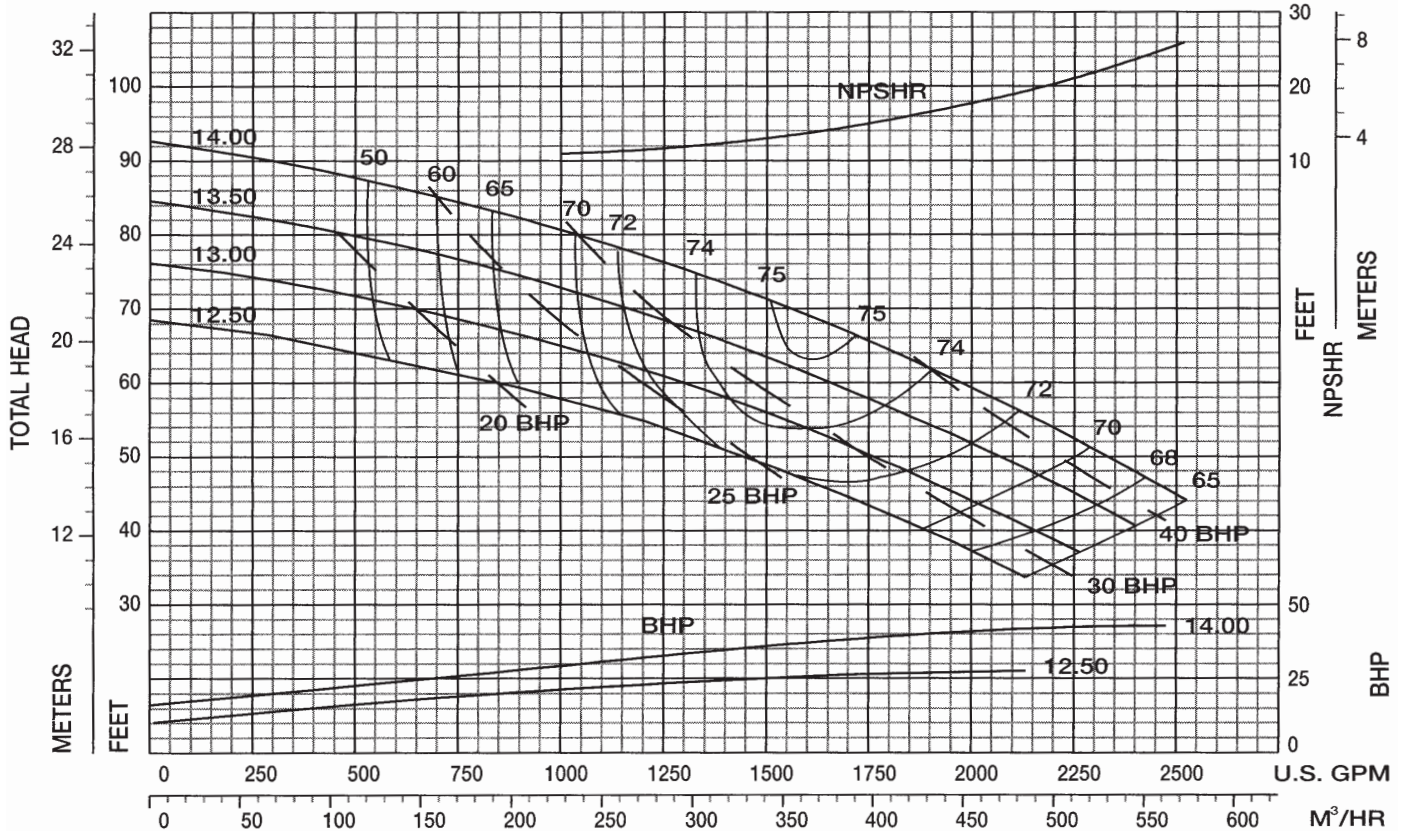

Performance Curve – 6" 5434 MV

RPM: 1185 SOLIDS: 3"

IMPELLER: TAJC5BH, 3 VANE SUCTION: 6" INLET: 60.58 in²

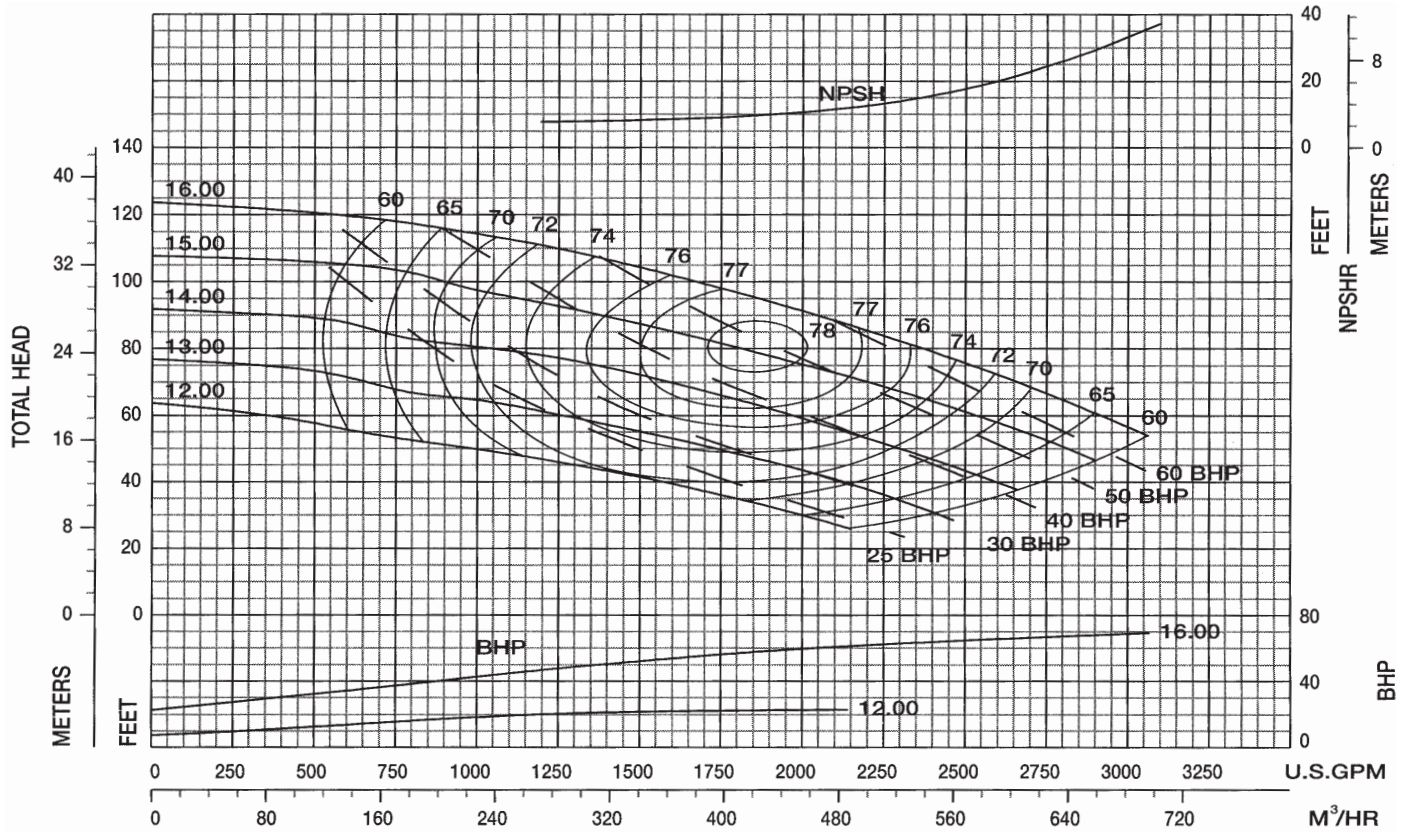

Performance Curve – 6" 5434 MV

RPM: 1185 SOLIDS: 4"

IMPELLER: TAJC5DC, 2 VANE SUCTION: 6" INLET: 70.58 in²

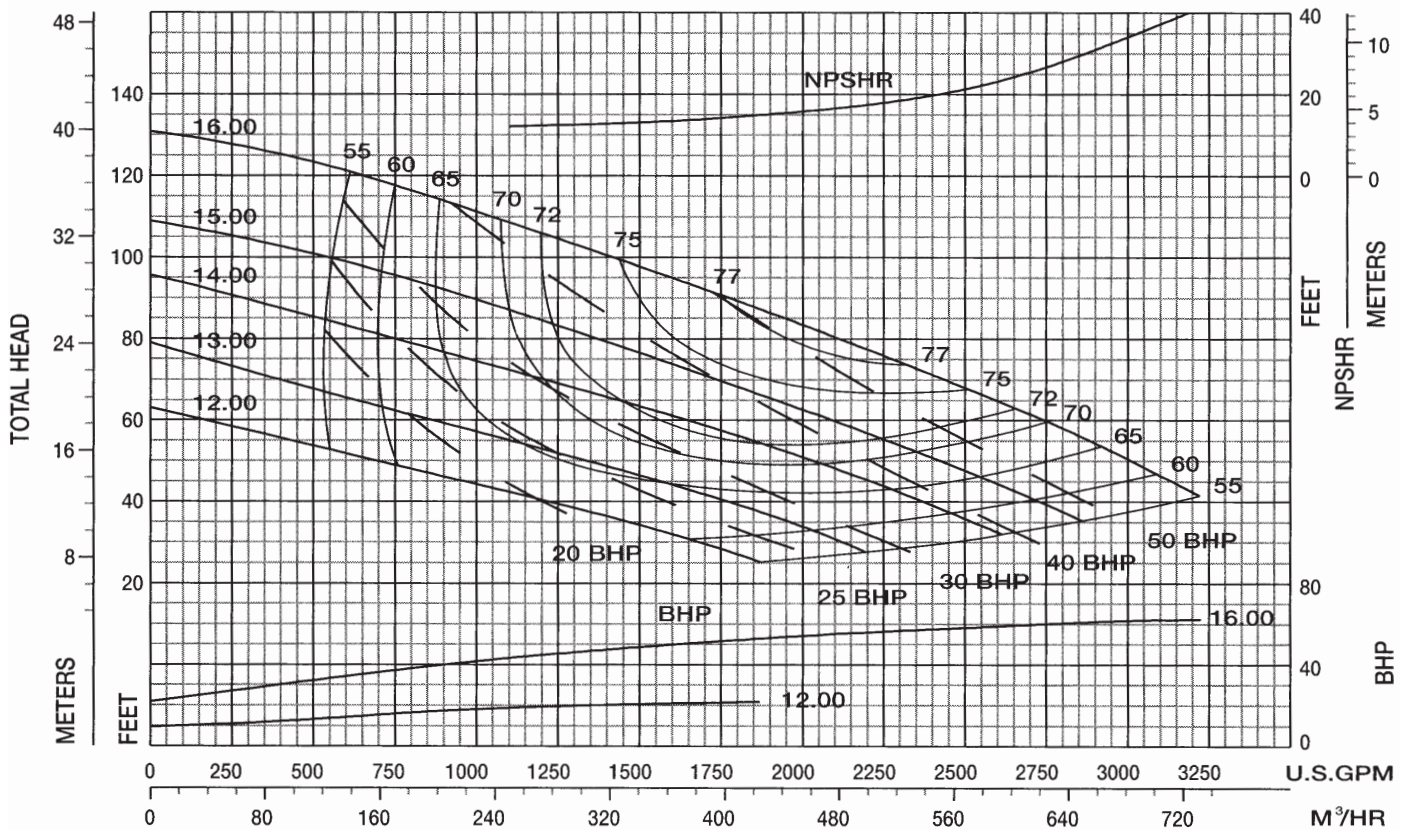

Performance Curve – 6" 5434 MV

RPM: 1185 SOLIDS: 3"

IMPELLER: TAJC5BJ, 3 VANE SUCTION: 6" INLET: 64.55 in²

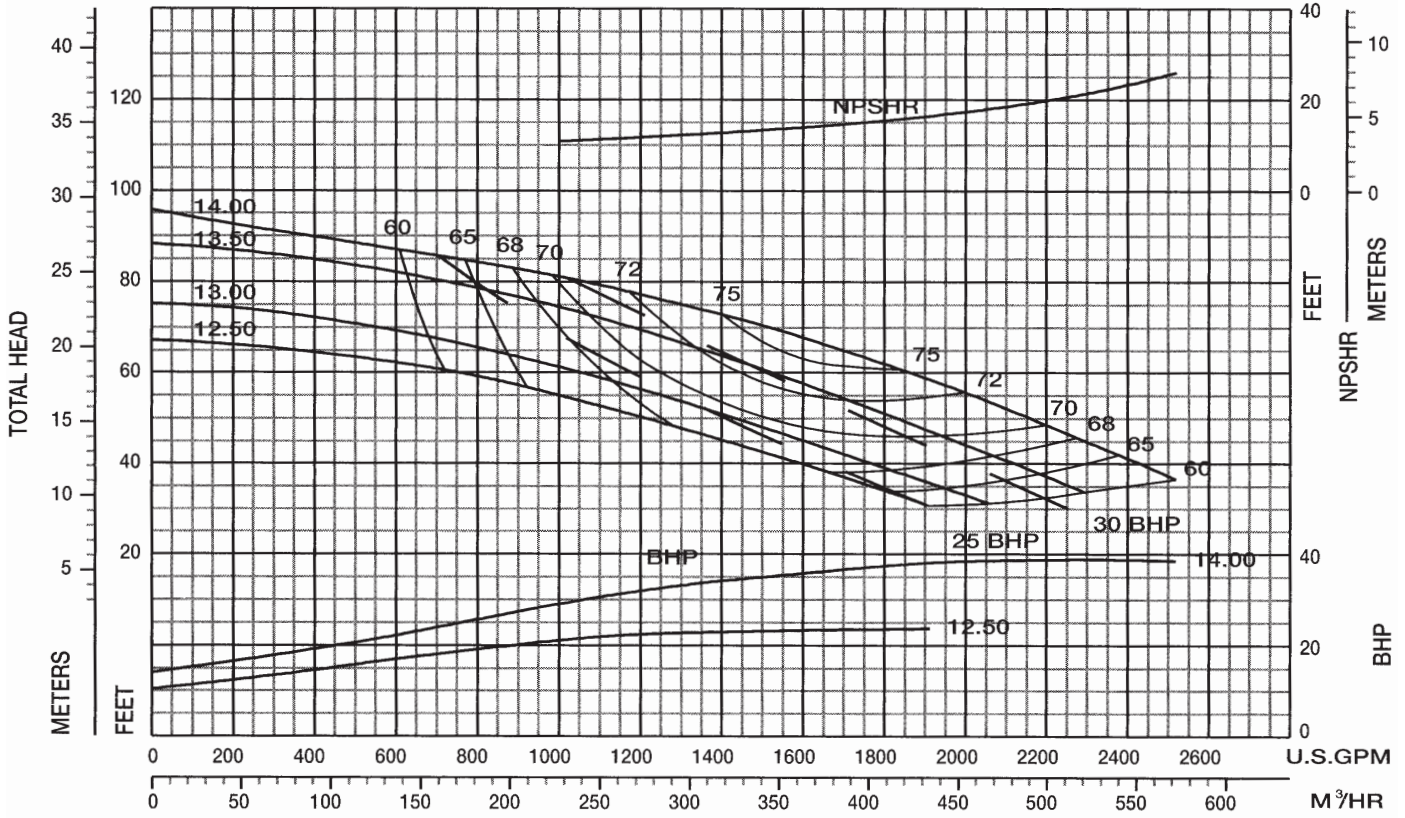

Performance Curve – 8" 5434S MT, W, WD

RPM: 1175 SOLIDS: 3-1/2"

IMPELLER: T8D1A, 2 VANE SUCTION: 10" (WD: 8" or 10") INLET: 62.99 in²

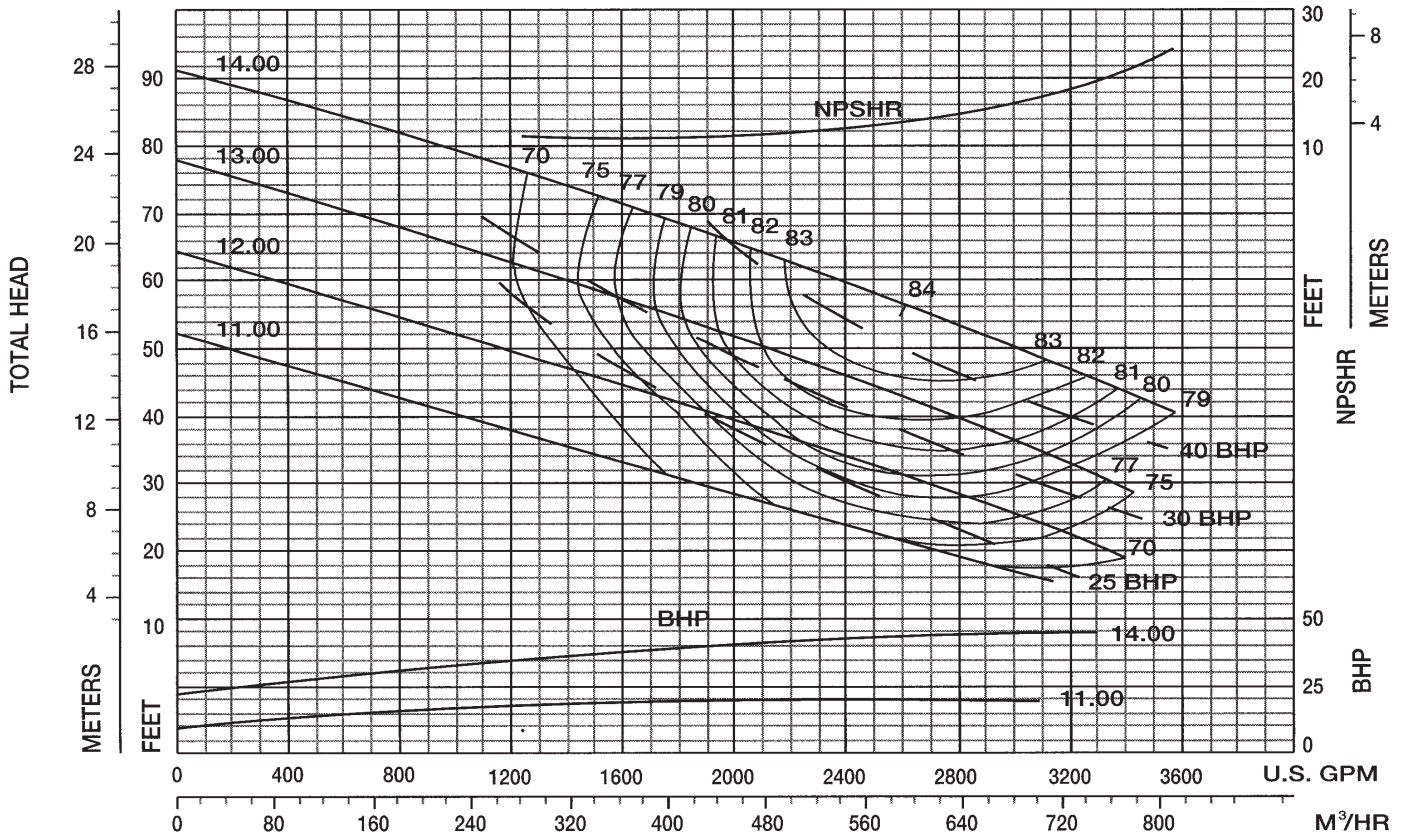

Performance Curve – 8" 5434L MTK, WK, WDK

RPM: 1180 SOLIDS: 5"

IMPELLER: T8D1G, BLADELESS SUCTION: 10" (WDK: 8" or 10") INLET: 50.30 in²

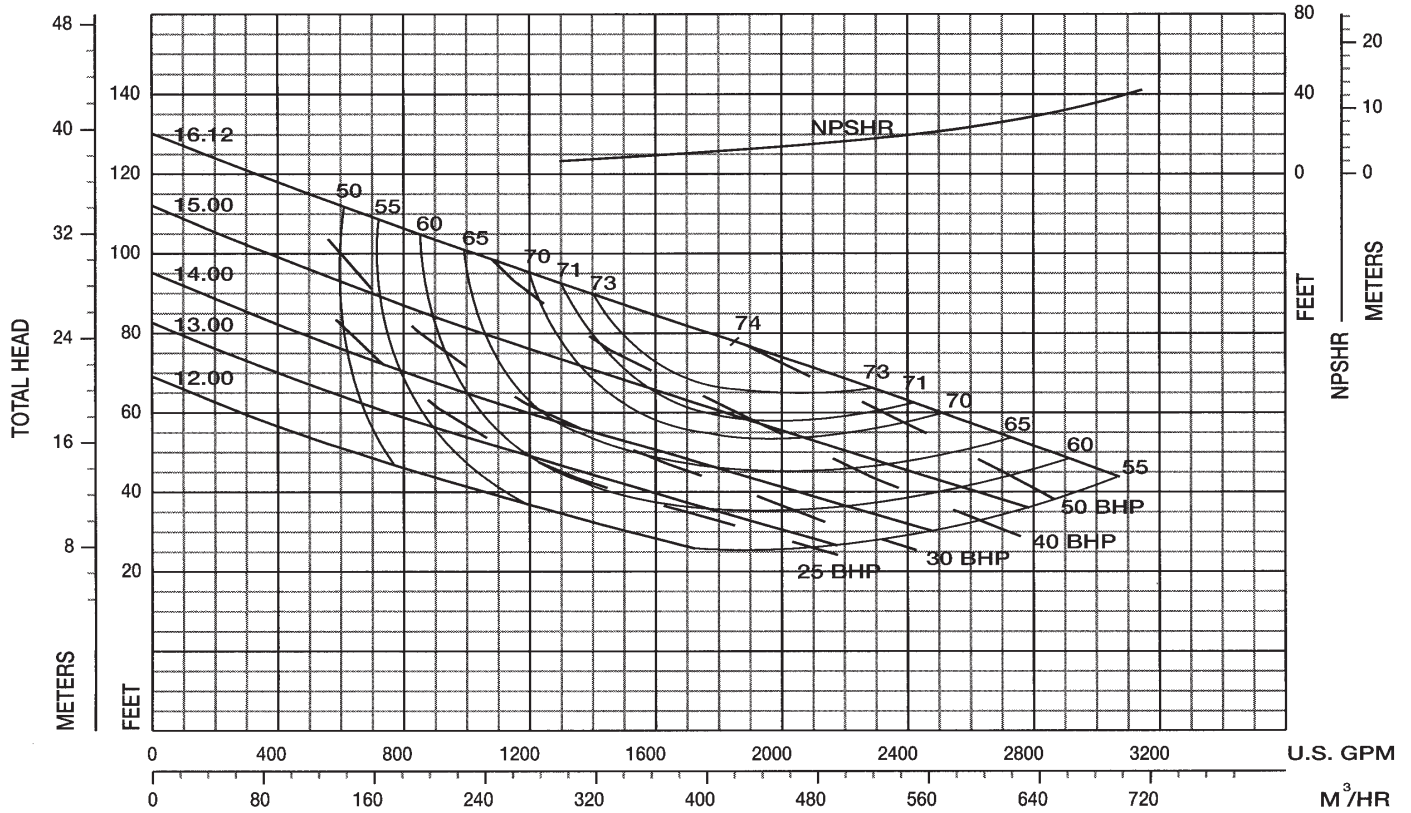

Performance Curve – 8" 5434L MT, W, WD

RPM: 1175 SOLIDS: 5"

IMPELLER: TAKC5W, 2 VANE SUCTION: 10" (WD: 8" or 10") INLET: 99.93 in²

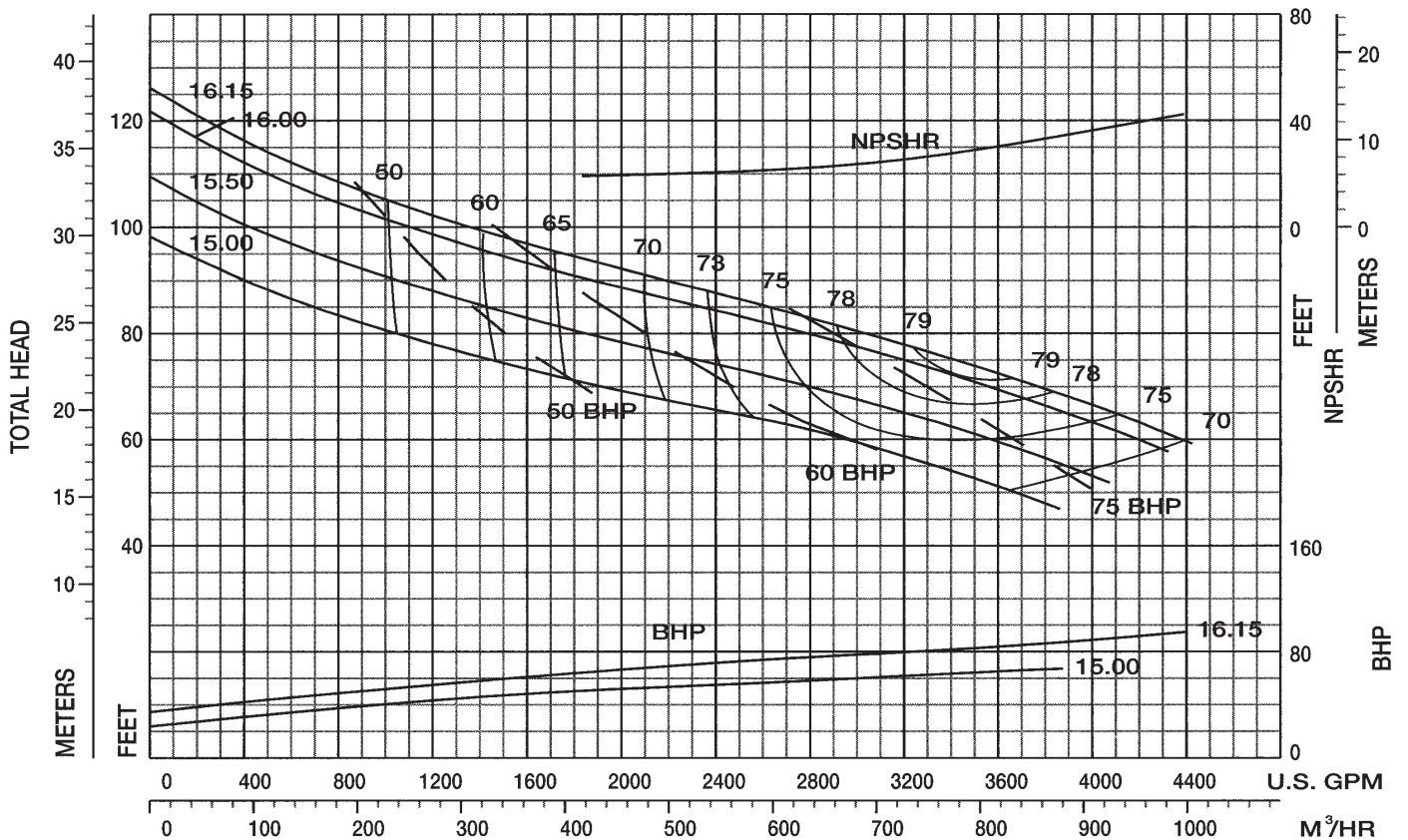

Performance Curve – 8" 5434L MT, W, WD

RPM: 1175 SOLIDS: 4"

IMPELLER: T8D1D, 2 VANE SUCTION: 10" (WD: 8" or 10") INLET: 72.94 in²

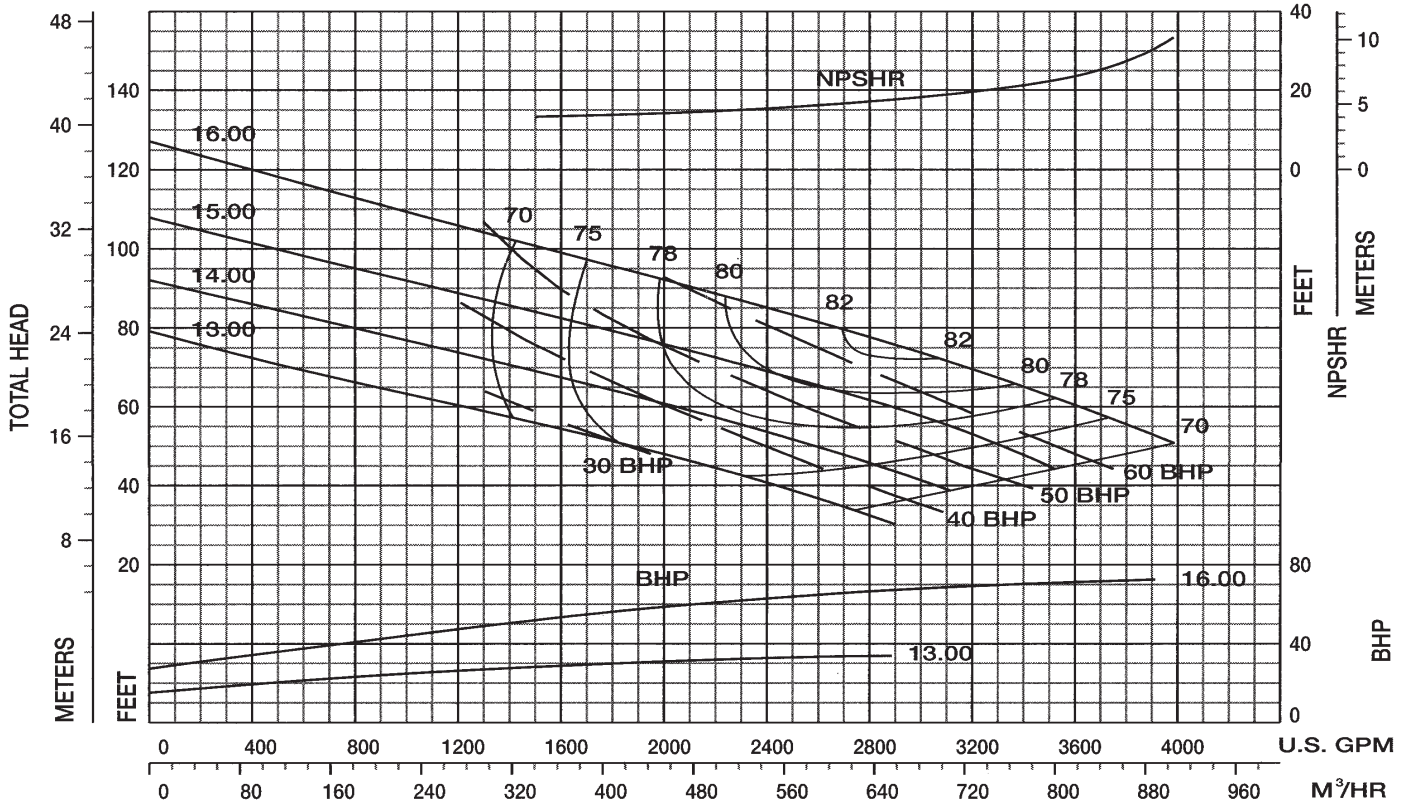

Performance Curve – 8" 5434S MV

RPM: 1185 SOLIDS: 3-1/2"

IMPELLER: T8D1A, 2 VANE SUCTION: 10" INLET: 62.99 in²

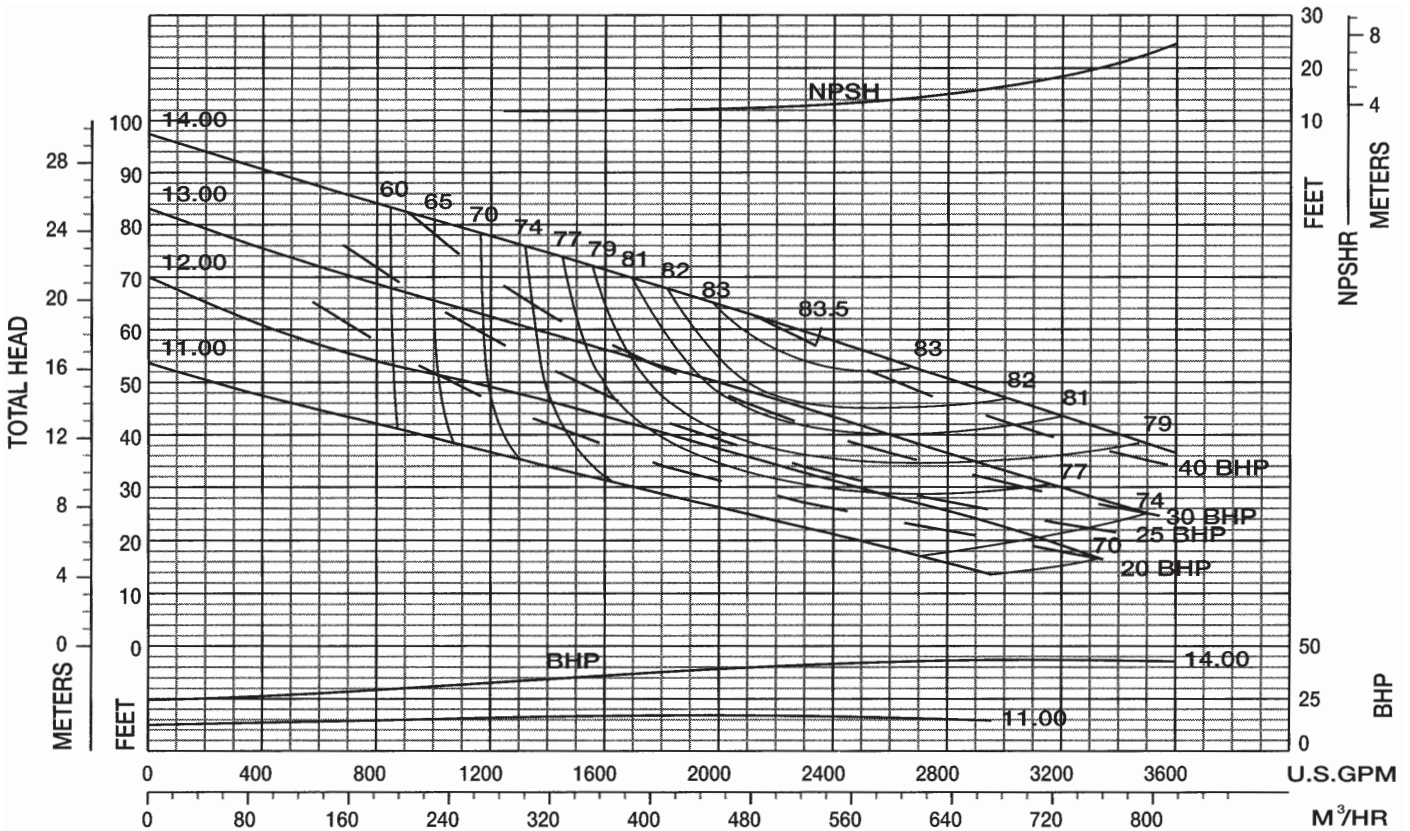

Performance Curve – 8" 5434L MV

RPM: 1185 SOLIDS: 5"

IMPELLER: TAKC5W, 2 VANE SUCTION: 10" INLET: 99.93 in²

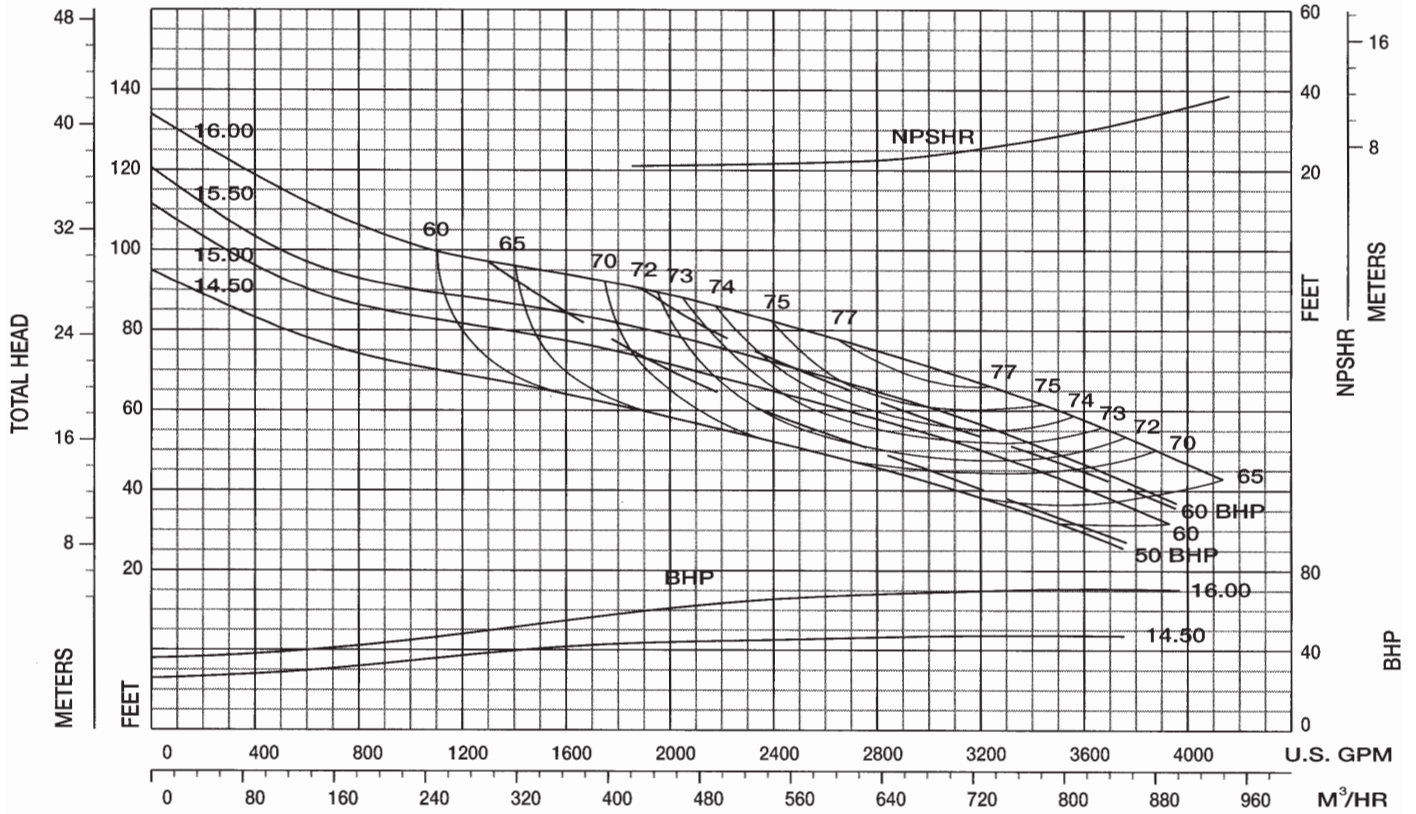

Performance Curve – 8" 5434L MV

RPM: 1185 SOLIDS: 4"

IMPELLER: T8D1D, 2 VANE SUCTION: 10" INLET: 72.94 in²

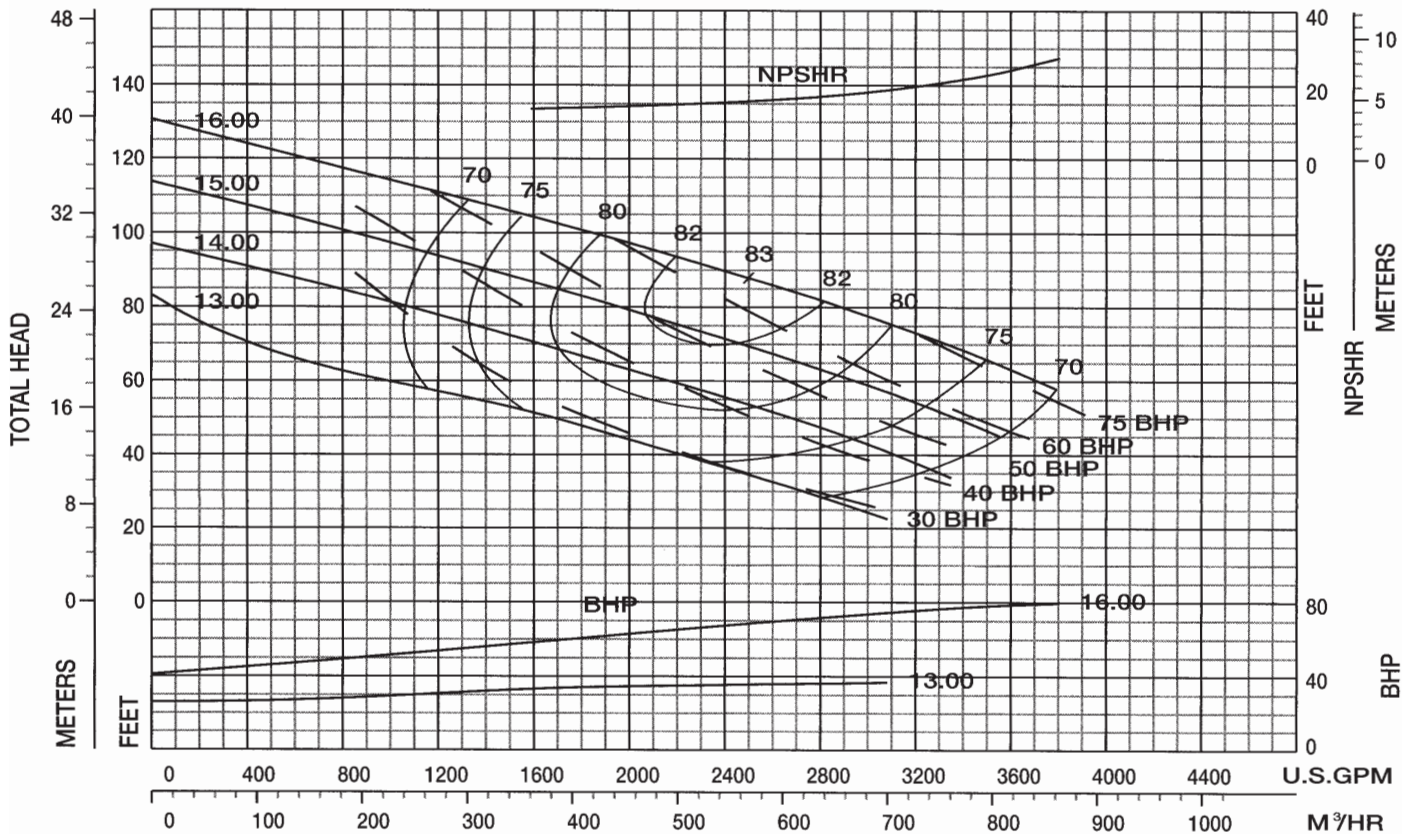

Performance Curve – 4" 5435 MT, W, WD

RPM: 1140 SOLIDS: 3"

IMPELLER: T4E1E, 2 VANE SUCTION: 4" (WD: 4" or 6") INLET: 35.65 in²

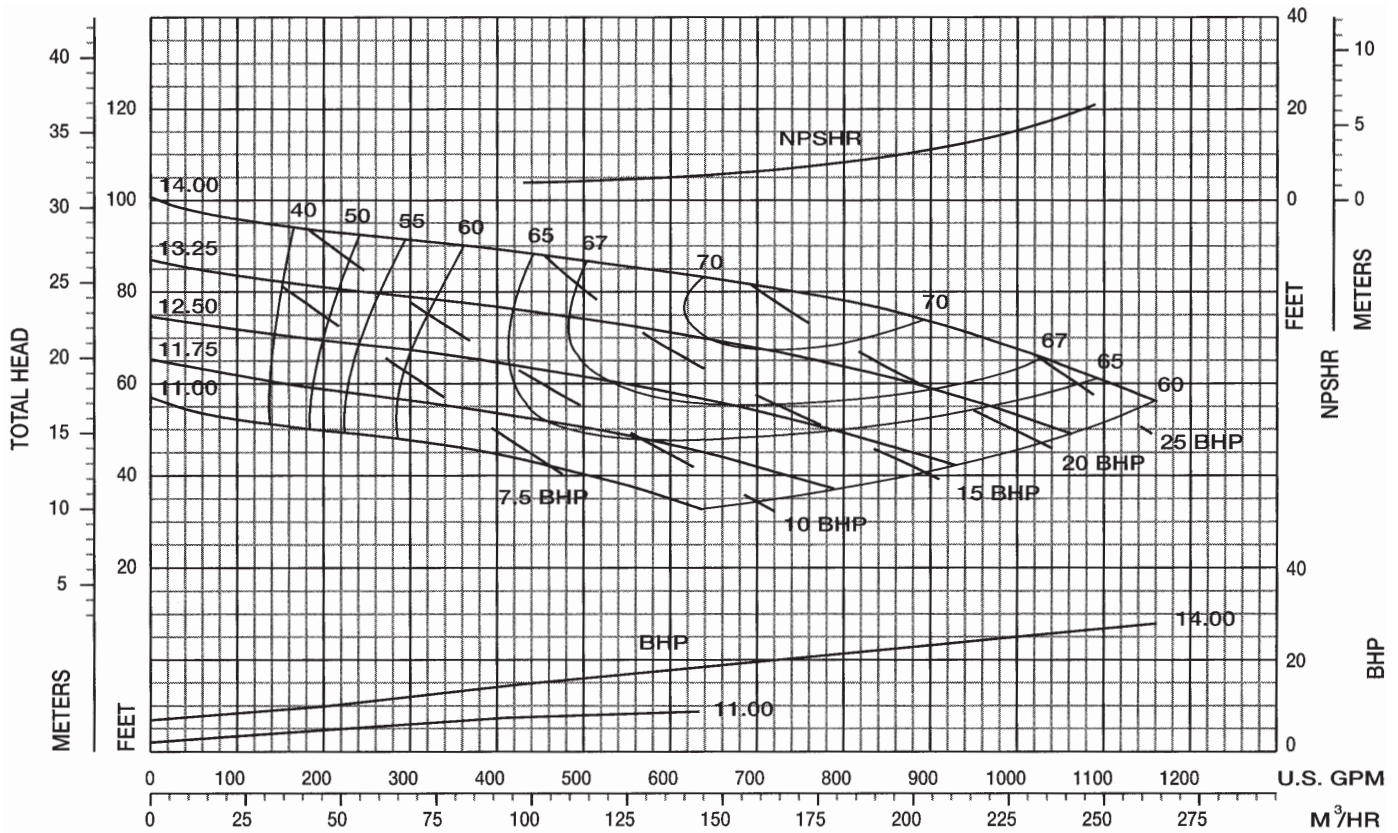

Performance Curve – 4" 5435 MV

RPM: 1180 SOLIDS: 3"

IMPELLER: T4E1E, 2 VANE SUCTION: 4" INLET: 35.65 in²

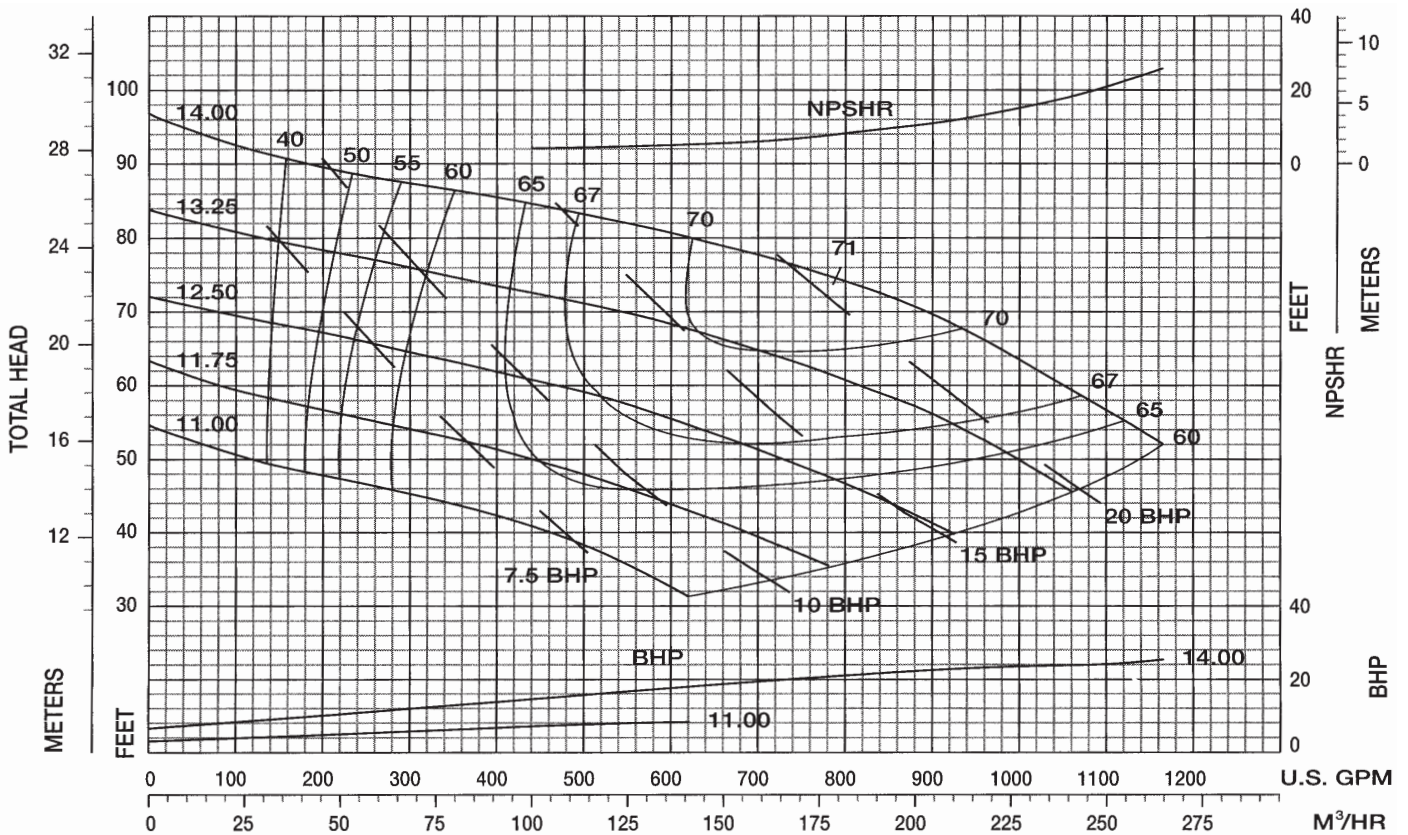

Performance Curve – 8" 5435 MT, W, WD

RPM: **1180** SOLIDS: **5"**

IMPELLER: **TAKE5N, 2 VANE** SUCTION: **8" (WD: 8" or 10")** INLET: **130.29 in²**

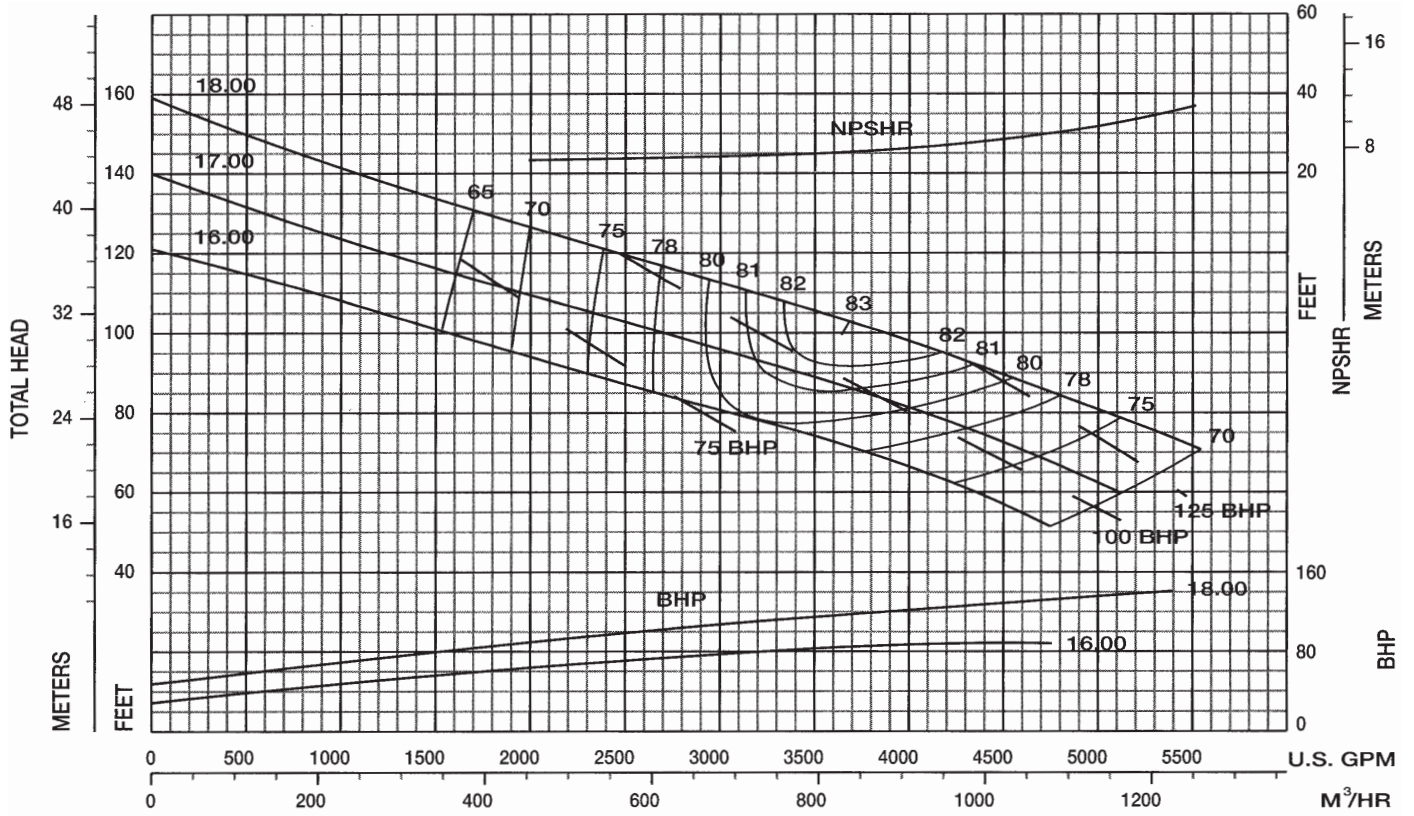

Performance Curve – 8" 5435 MV

RPM: **1185** SOLIDS: **5"**

IMPELLER: **TAKE5N, 2 VANE** SUCTION: **8"** INLET: **130.29 in²**

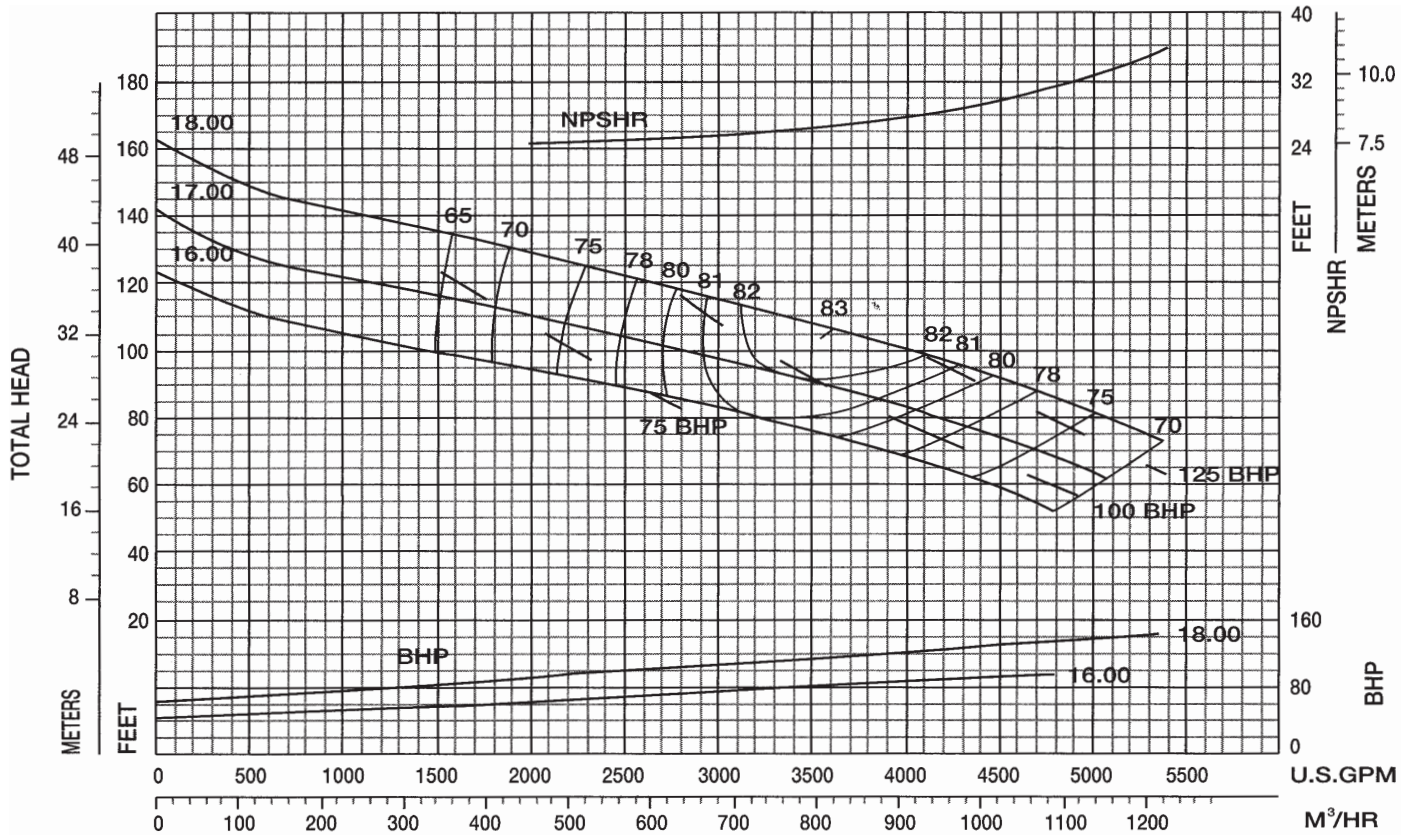

Performance Curve – 10" 5435 MT, W, WD

RPM: 1185 SOLIDS: 6"

IMPELLER: TALE5A, 2 VANE SUCTION: 10" (WD: 10" or 12") INLET: 127.43 in²

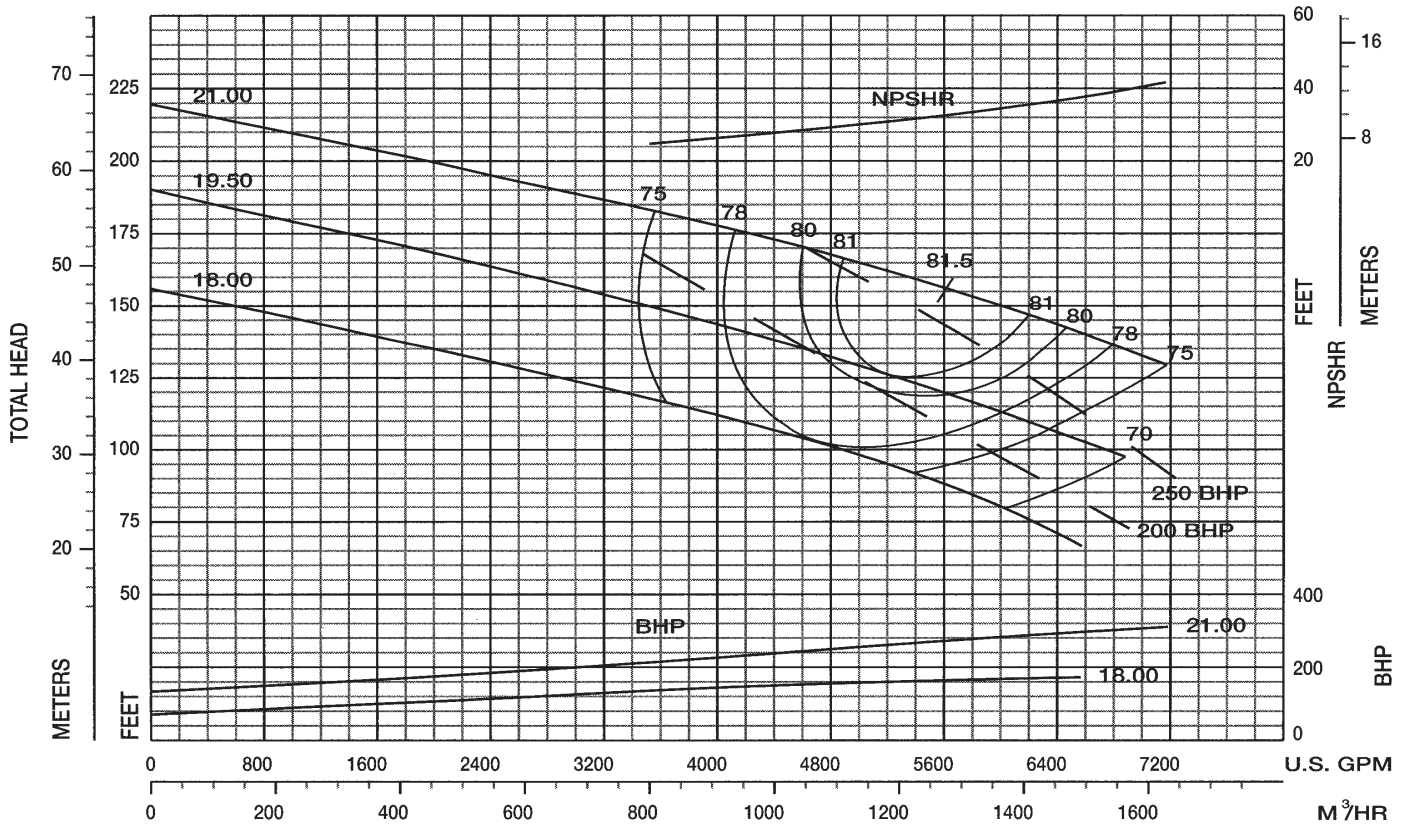

Performance Curve – 10" 5435 MV

RPM: 1185 SOLIDS: 6"

IMPELLER: TALE5A, 2 VANE SUCTION: 10" INLET: 127.43 in²

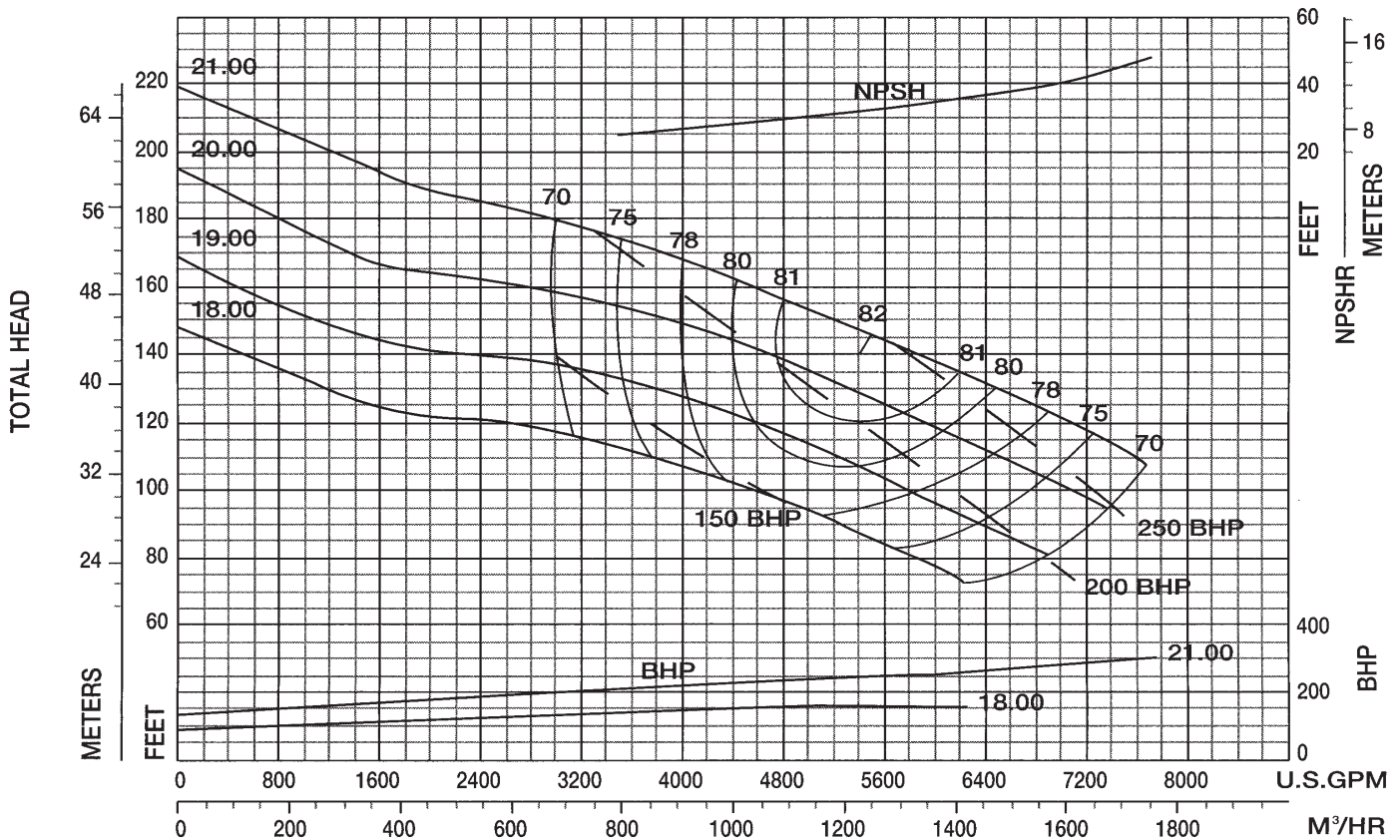

Performance Curve – 5" 5436 MT, W, WD

RPM: 1180 SOLIDS: 3"

IMPELLER: T5D1AS, 2 VANE SUCTION: 8" (WD: 8" or 10") INLET: 35.80 in²

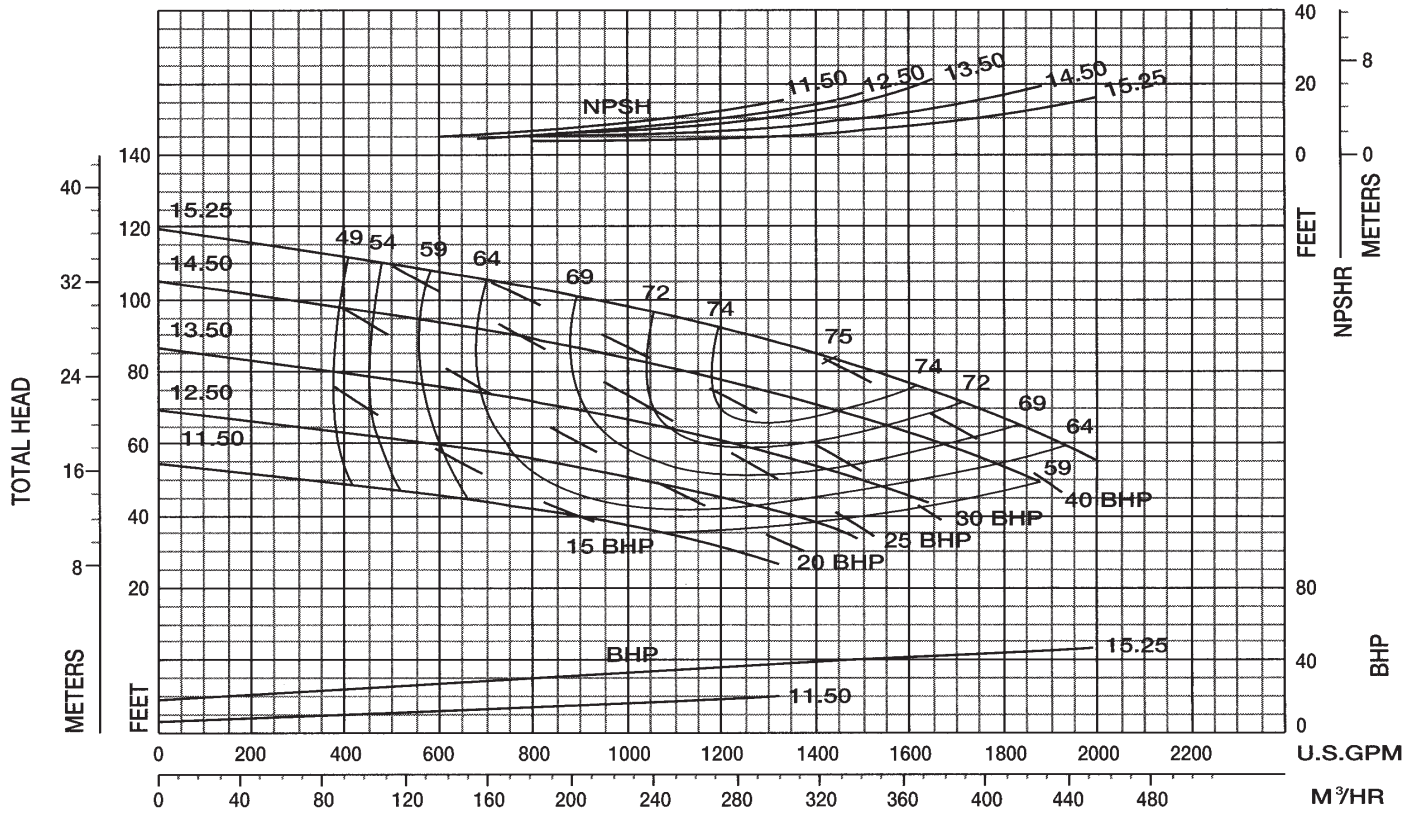

Performance Curve – 5" 5436 MV

RPM: 1180 SOLIDS: 3"

IMPELLER: T5D1AS, 2 VANE SUCTION: 5" INLET: 52.05 in²

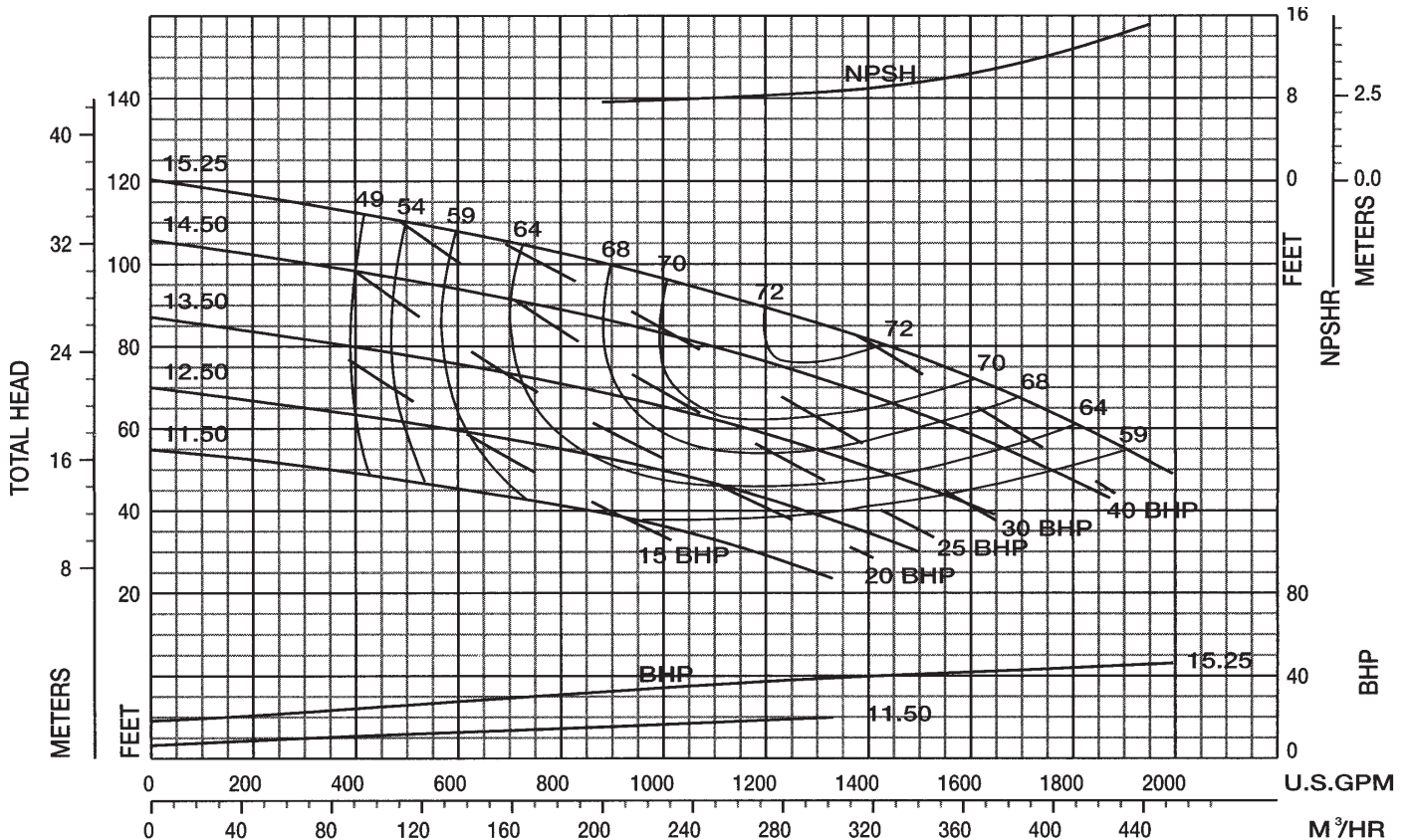

Performance Curve – 6" 5436 MT, W, WD

RPM: 1175 SOLIDS: 3"

IMPELLER: T6E1G, 2 VANE SUCTION: 10" INLET: 59.32 in²

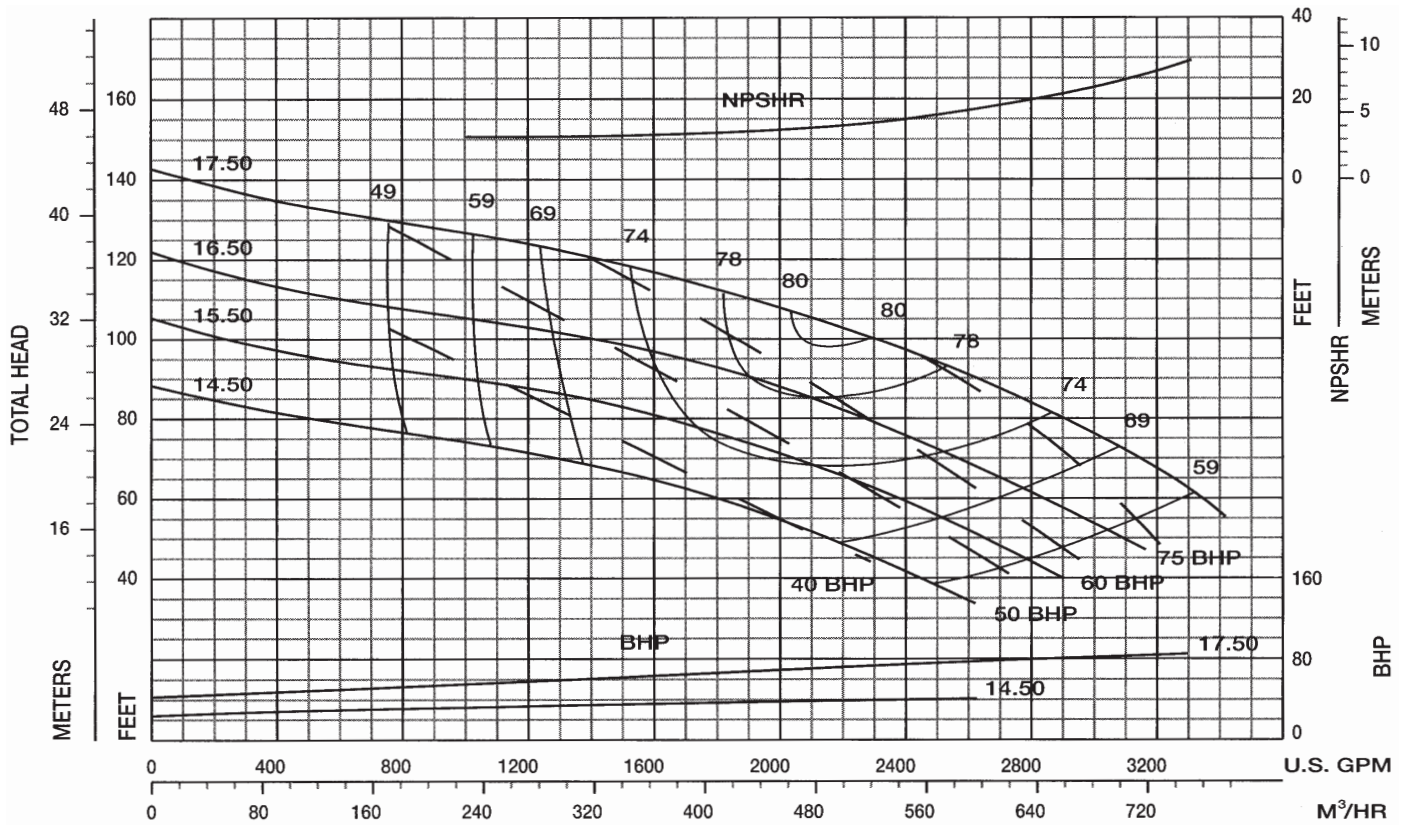

Performance Curve – 6" 5436L W, WD

RPM: 1185 SOLIDS: 3"

IMPELLER: T6F1C, 3 VANE SUCTION: 10" INLET: 93.30 in²

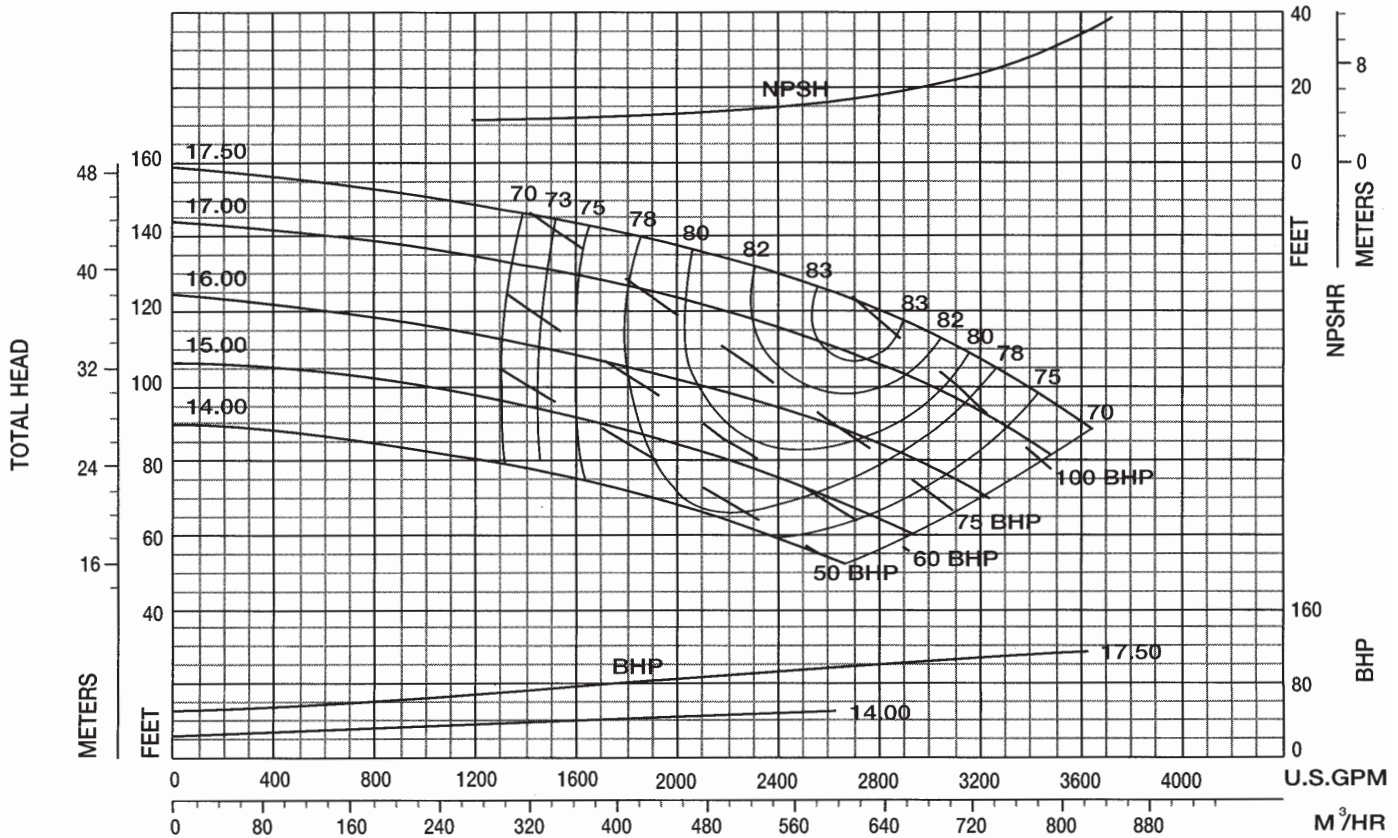

Performance Curve – 8" 5436S MT, W, WD

RPM: 1185 SOLIDS: 3"

IMPELLER: T8F1C, 3 VANE SUCTION: 10" INLET: 93.30 in²

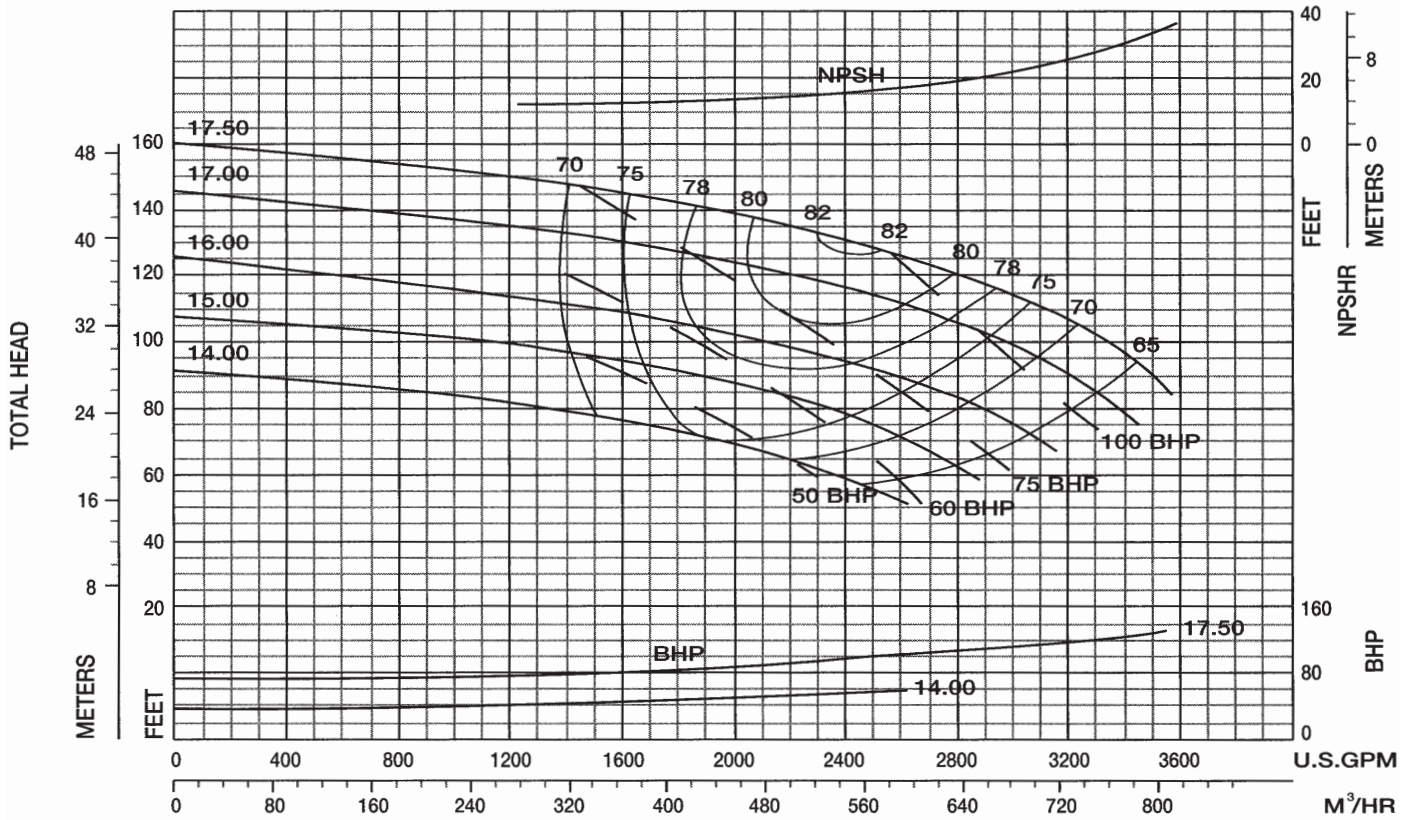

Performance Curve – 8" 5436S MV

RPM: 1185 SOLIDS: 3"

IMPELLER: T8F1C, 3 VANE SUCTION: 8" INLET: 93.30 in²

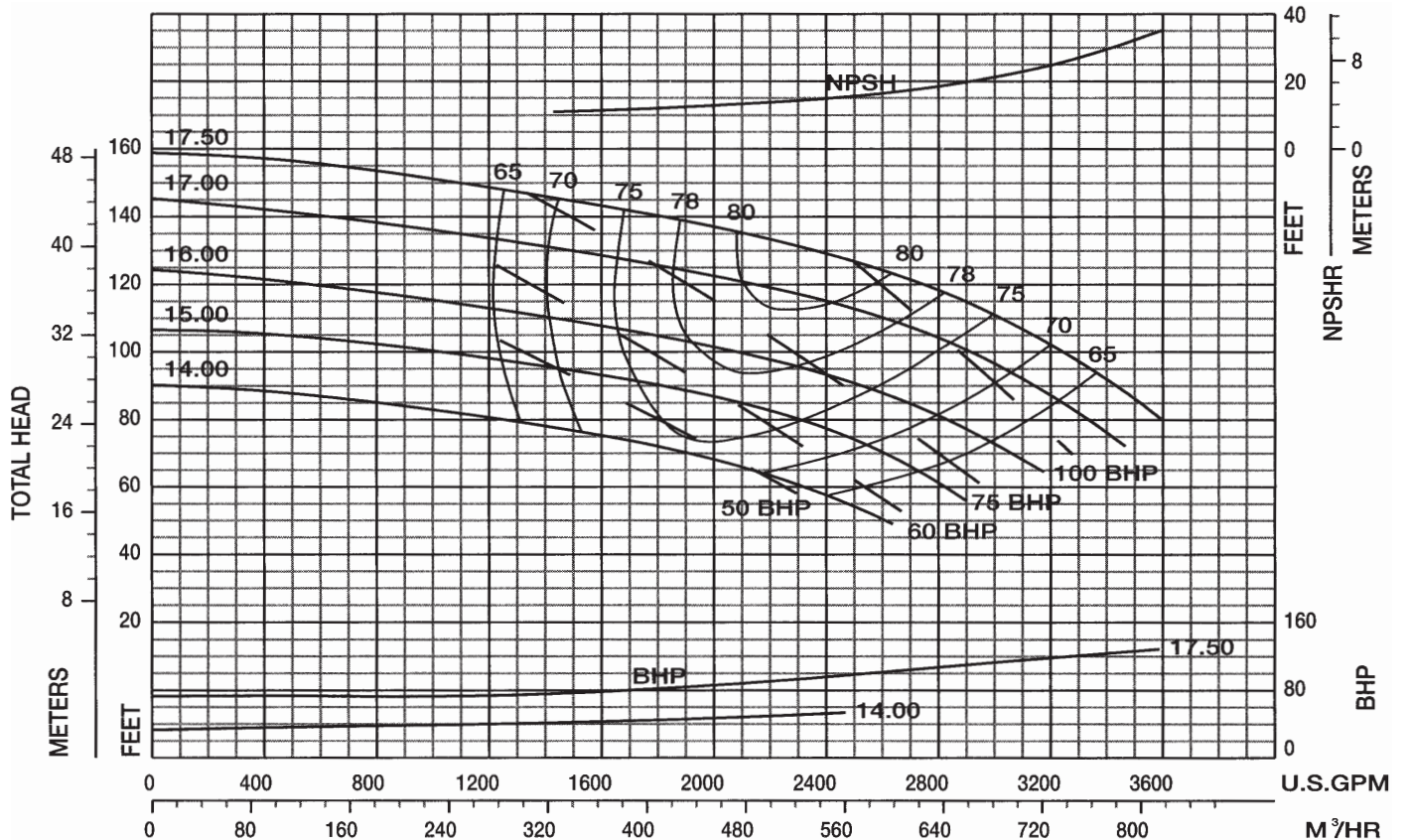

Performance Curve – 8" 5436 MT, W, WD

RPM: 1185 SOLIDS: 5"

IMPELLER: TAKE5DF, 2 VANE SUCTION: 10" (WD: 12") INLET: 93.22 in²

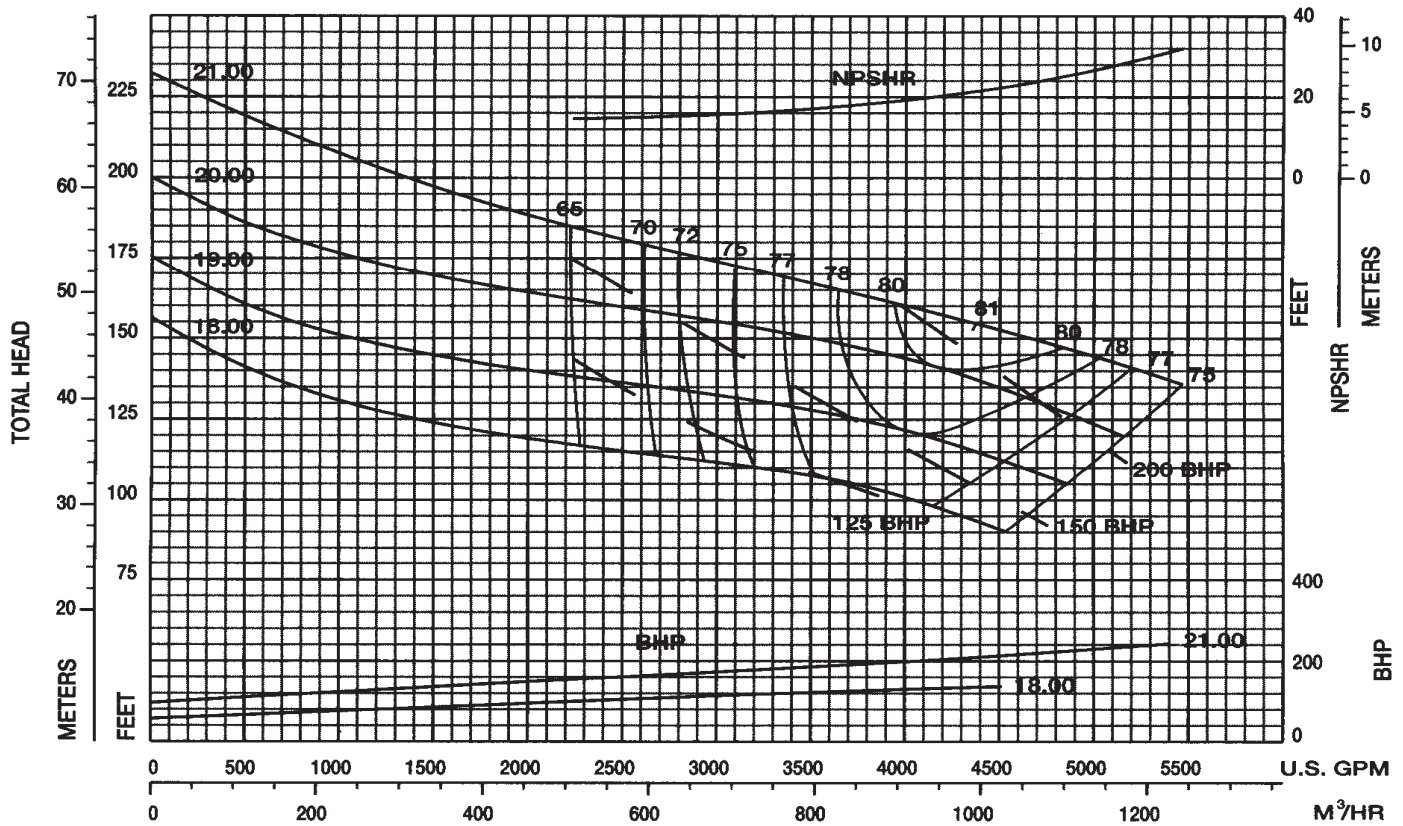

Performance Curve – 8" 5436 MV

RPM: 1180 SOLIDS: 5"

IMPELLER: TAKE5DF, 2 VANE SUCTION: 8" INLET: 93.22 in²

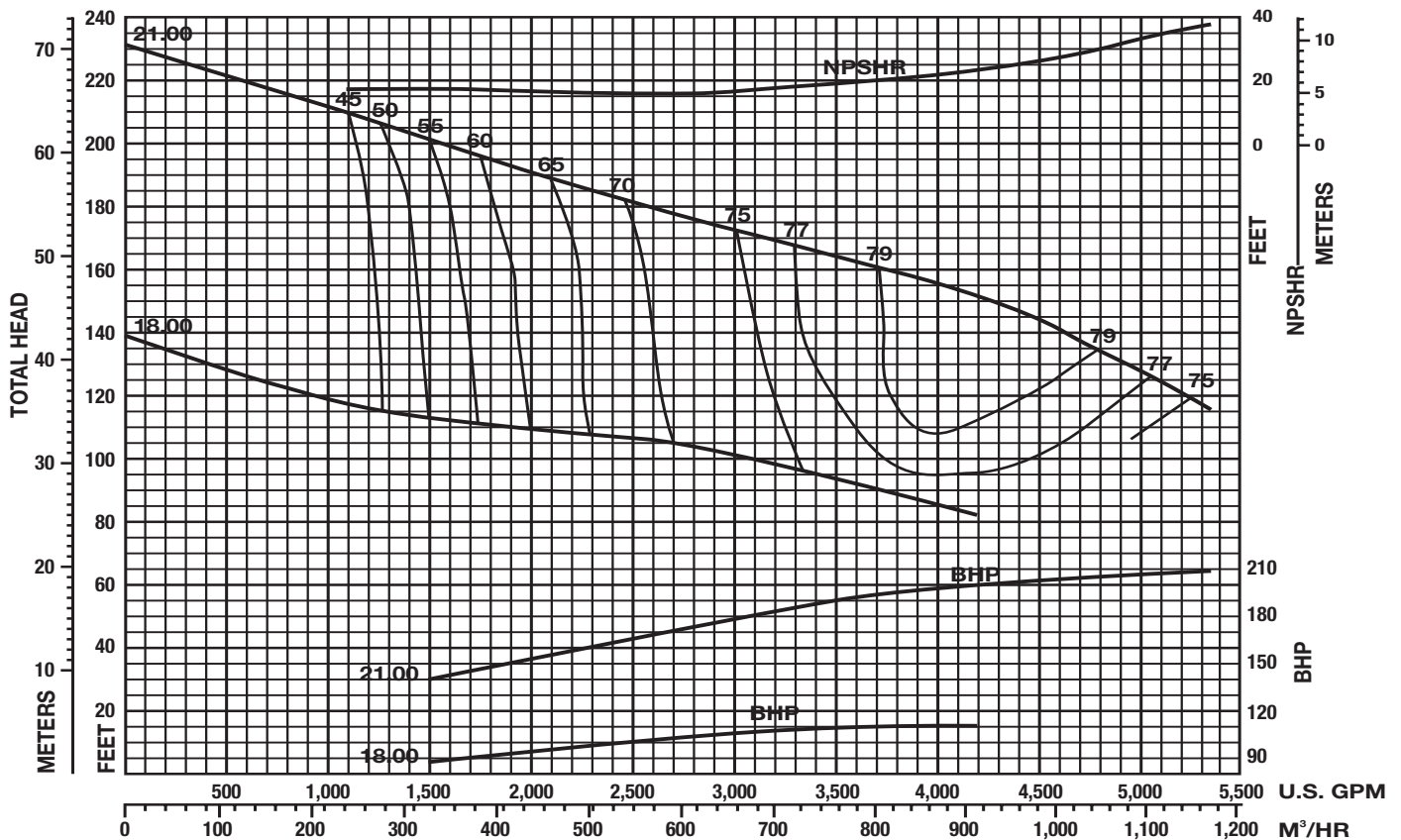

Performance Curve – 2" 5432 MTK, WK, WDK

RPM: **865** SOLIDS: **1-1/2"**

IMPELLER: **T2B1AE, BLADELESS** SUCTION: 2" INLET: 5.09 in²

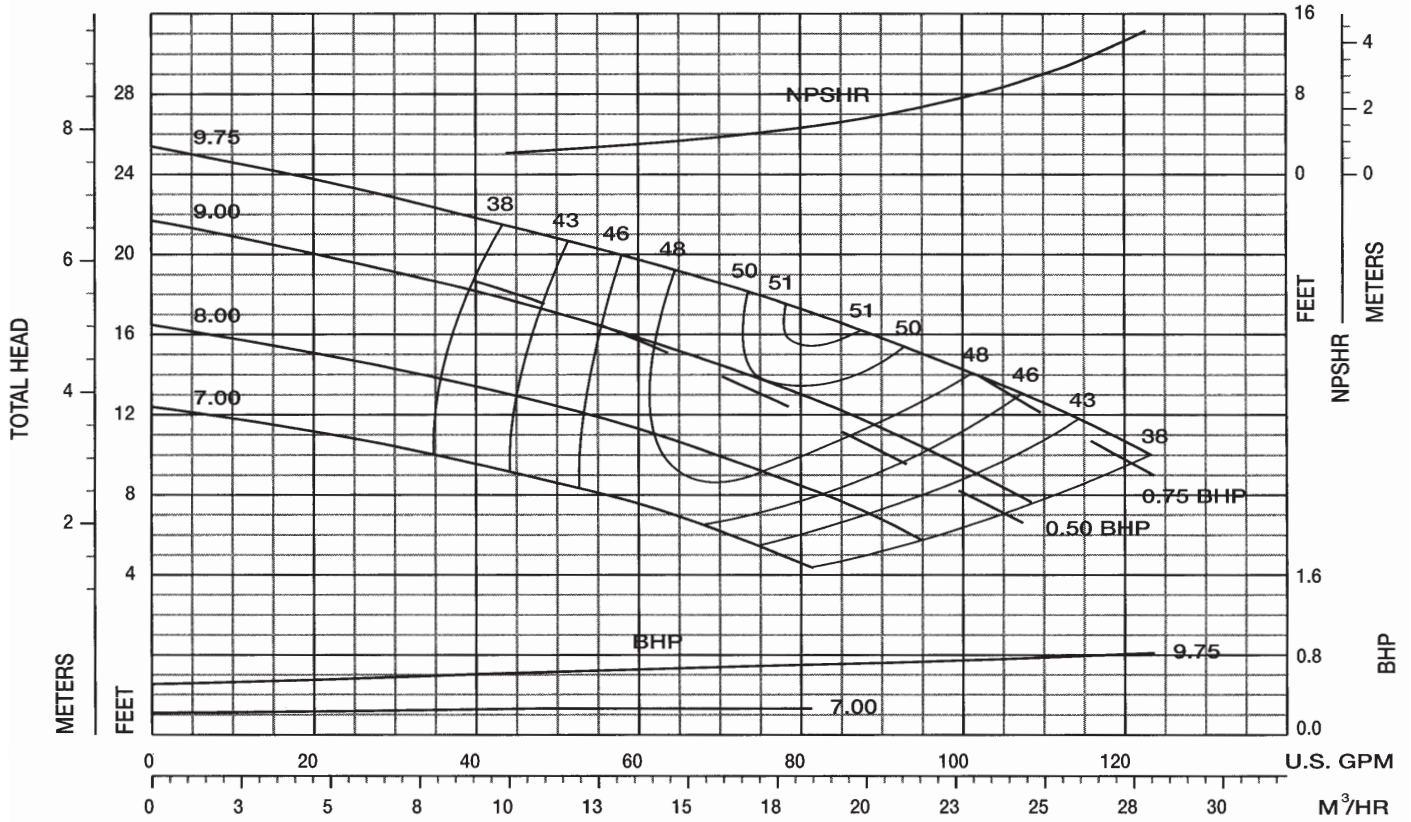

Performance Curve – 2" 5432 MT, W, WD

RPM: **855** SOLIDS: **1-1/2"**

IMPELLER: **T2B1A, 2 VANE** SUCTION: 2" INLET: 14.91 in²

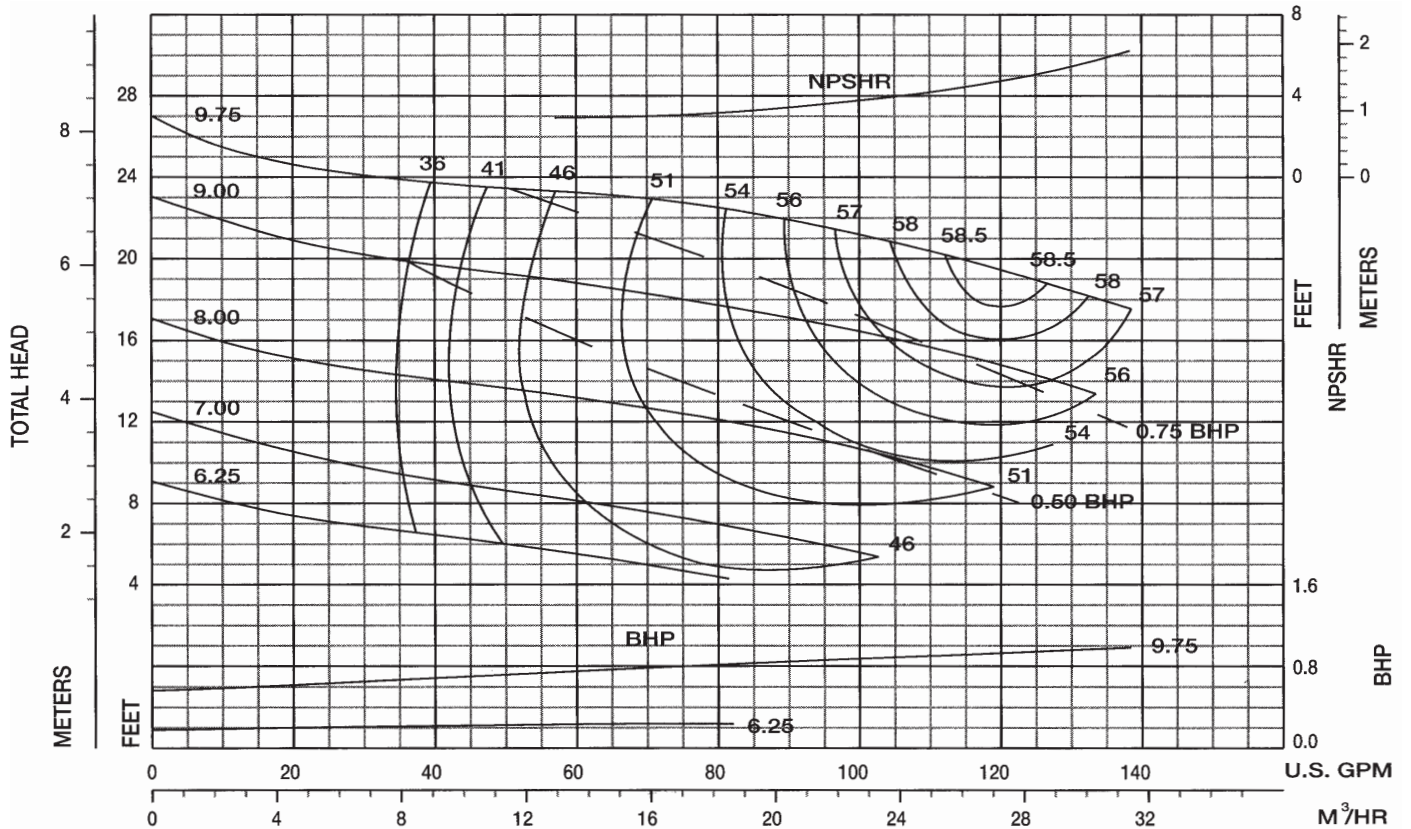

Performance Curve – 3" 5432 MTK, MVK, WK, WDK

RPM: 865 SOLIDS: 2"

IMPELLER: T3B1AH, BLADELESS SUCTION: 3" (WDK: 3" or 4") INLET: 11.46 in²

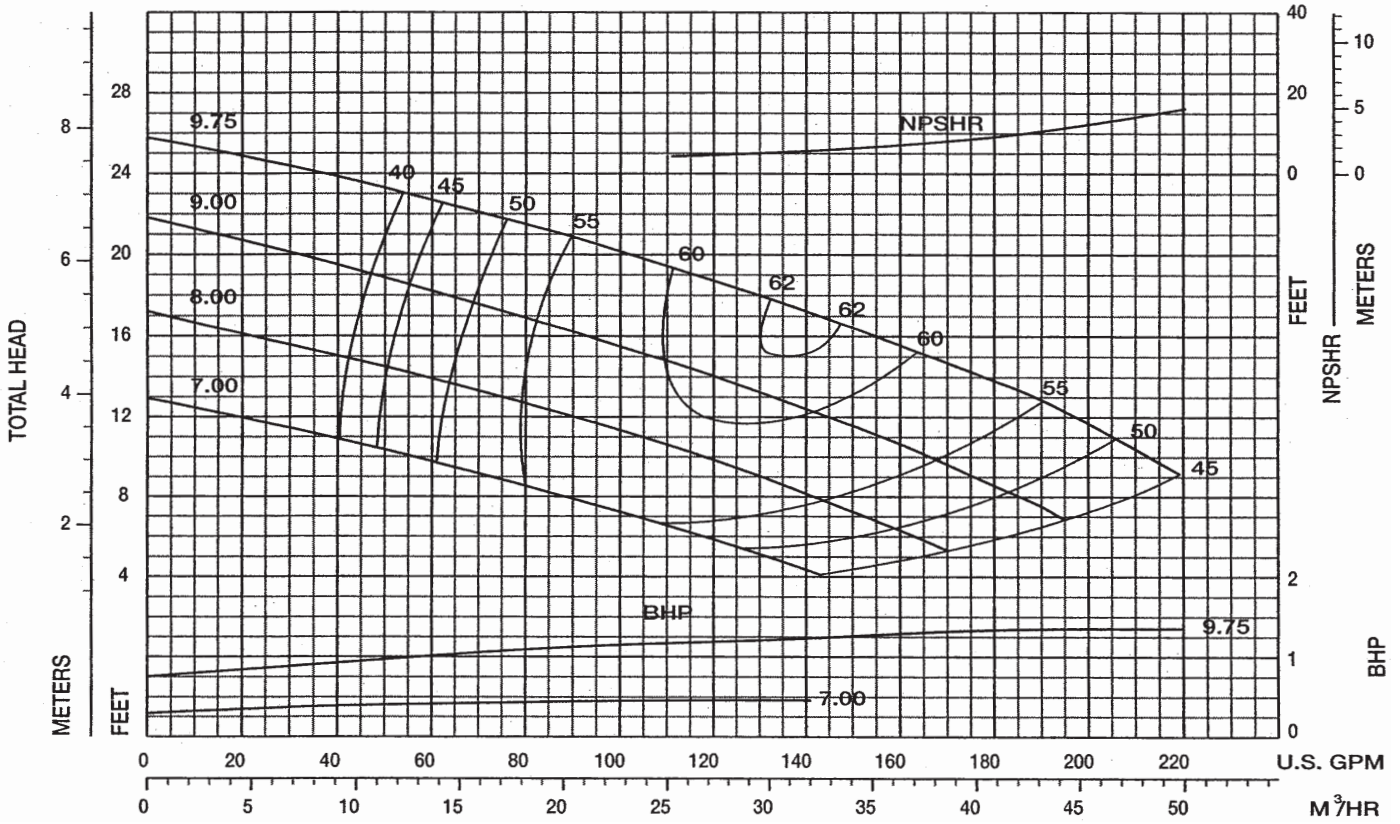

Performance Curve – 3" 5432 MT, MV, W, WD

RPM: 855 SOLIDS: 2"

IMPELLER: T3B1A, 2 VANE SUCTION: 3" (WD: 3" or 4") INLET: 20.39 in²

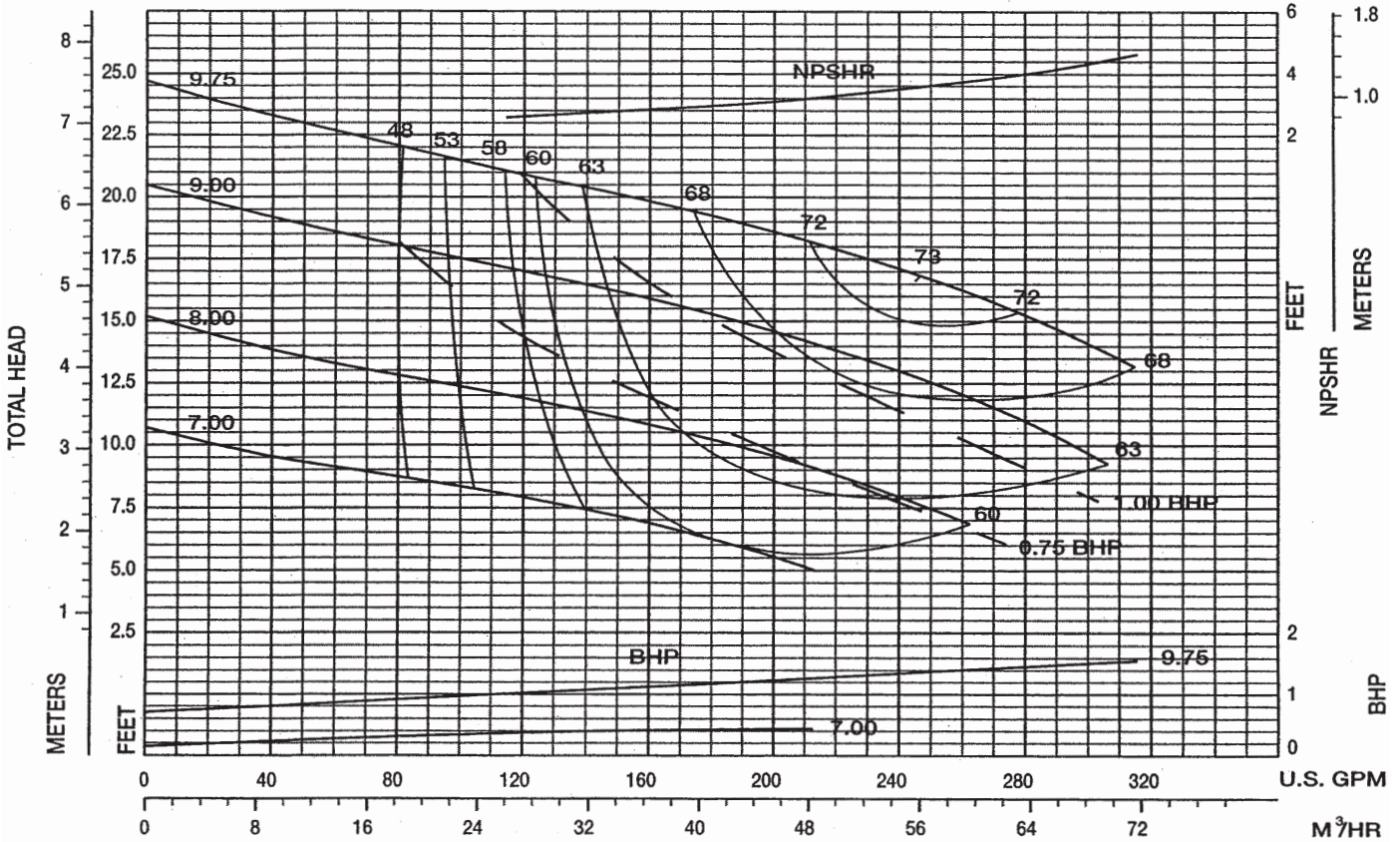

Performance Curve – 4" 5432 MTK, WK, WDK, CWDK

RPM: 860 SOLIDS: 3"

IMPELLER: T4B1AF, BLADELESS SUCTION: 4" (WDK: 4" or 6") INLET: 26.72 in²

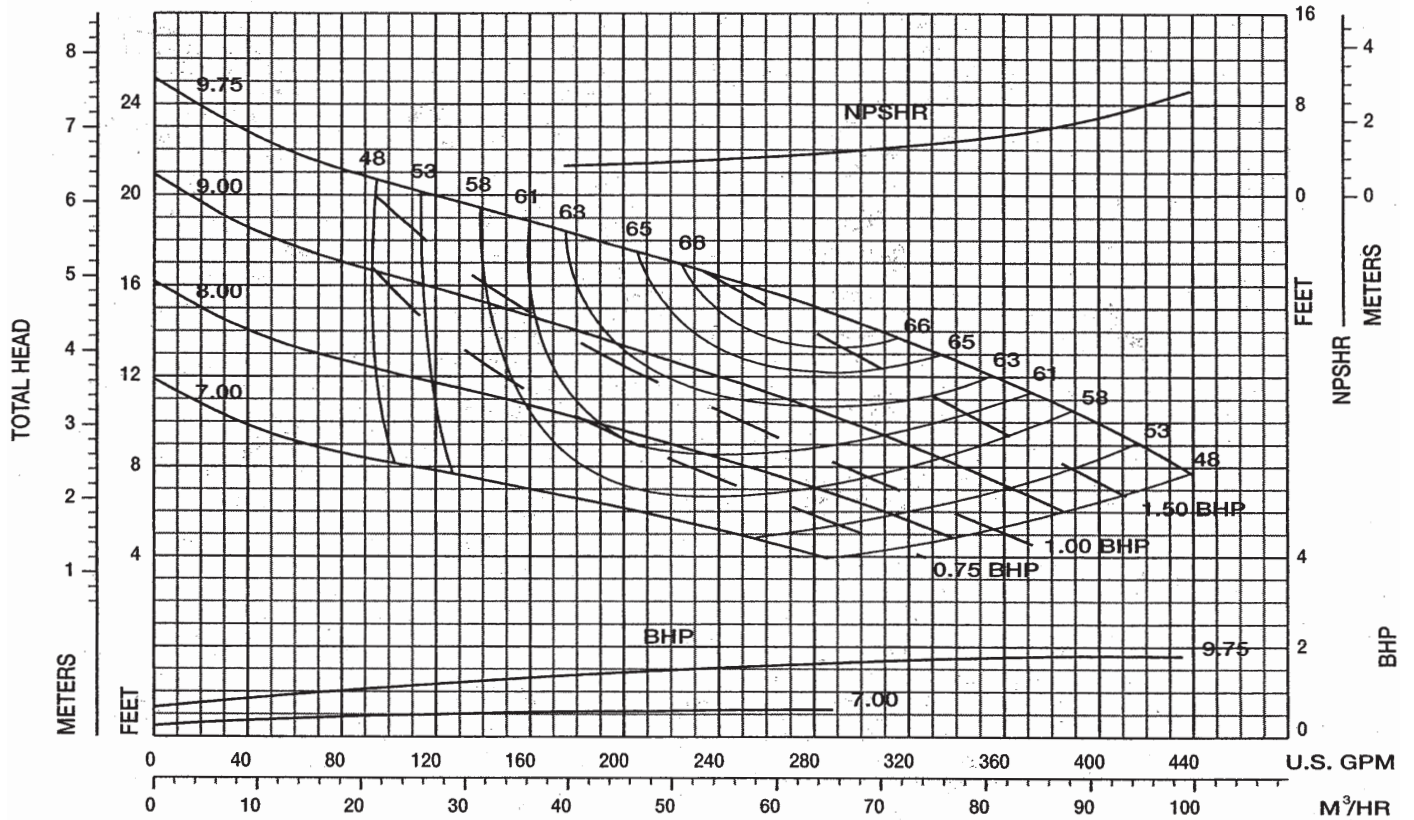

Performance Curve – 4" 5432 MT, W, WD

RPM: 855 SOLIDS: 3"

IMPELLER: T4B1A, 2 VANE SUCTION: 4" (WD: 4" or 6") INLET: 26.22 in²

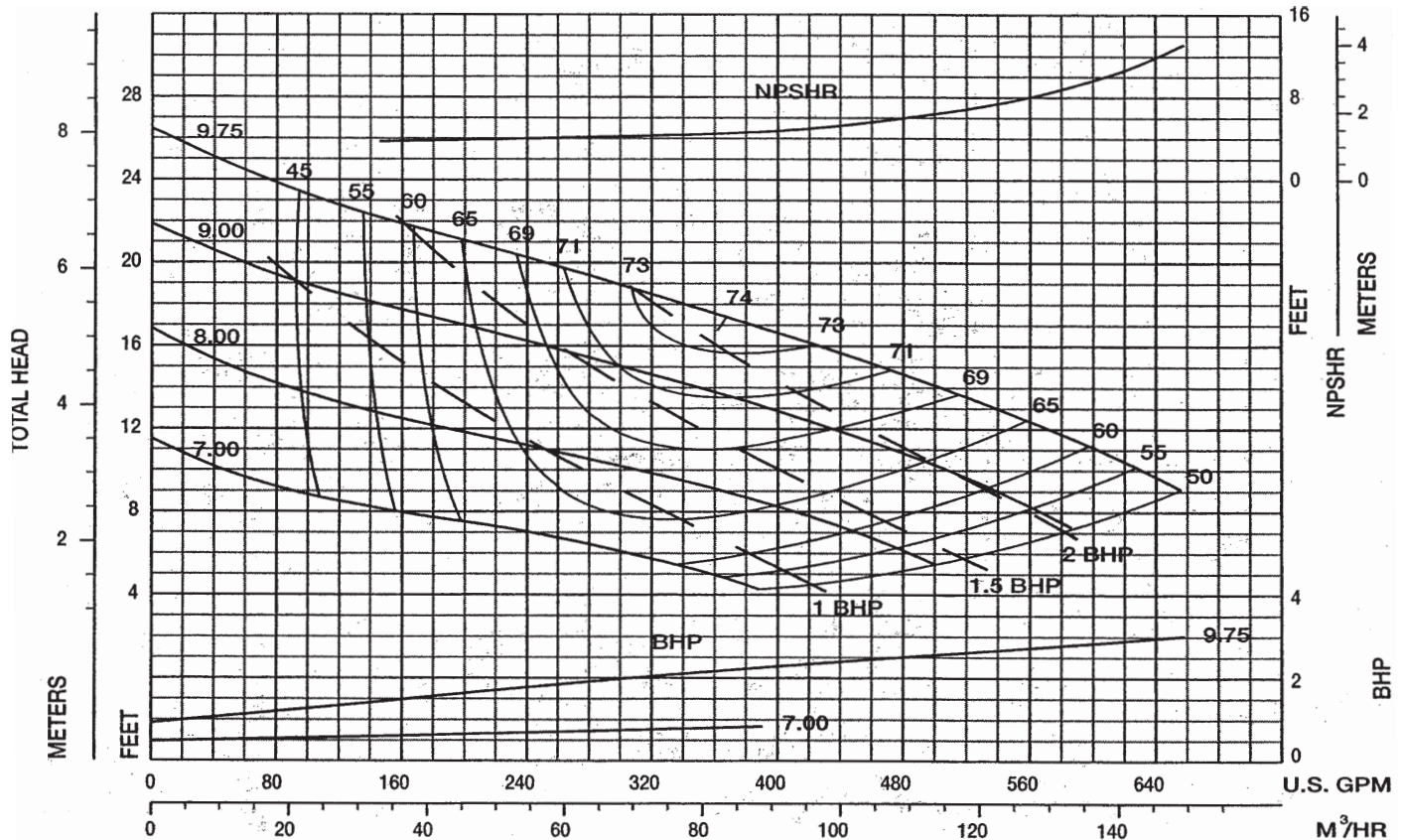

Performance Curve - 4" 5432 MVK

RPM: 860 SOLIDS: 3"

IMPELLER: T4B1AF, BLADELESS SUCTION: 4" INLET: 26.72 in²

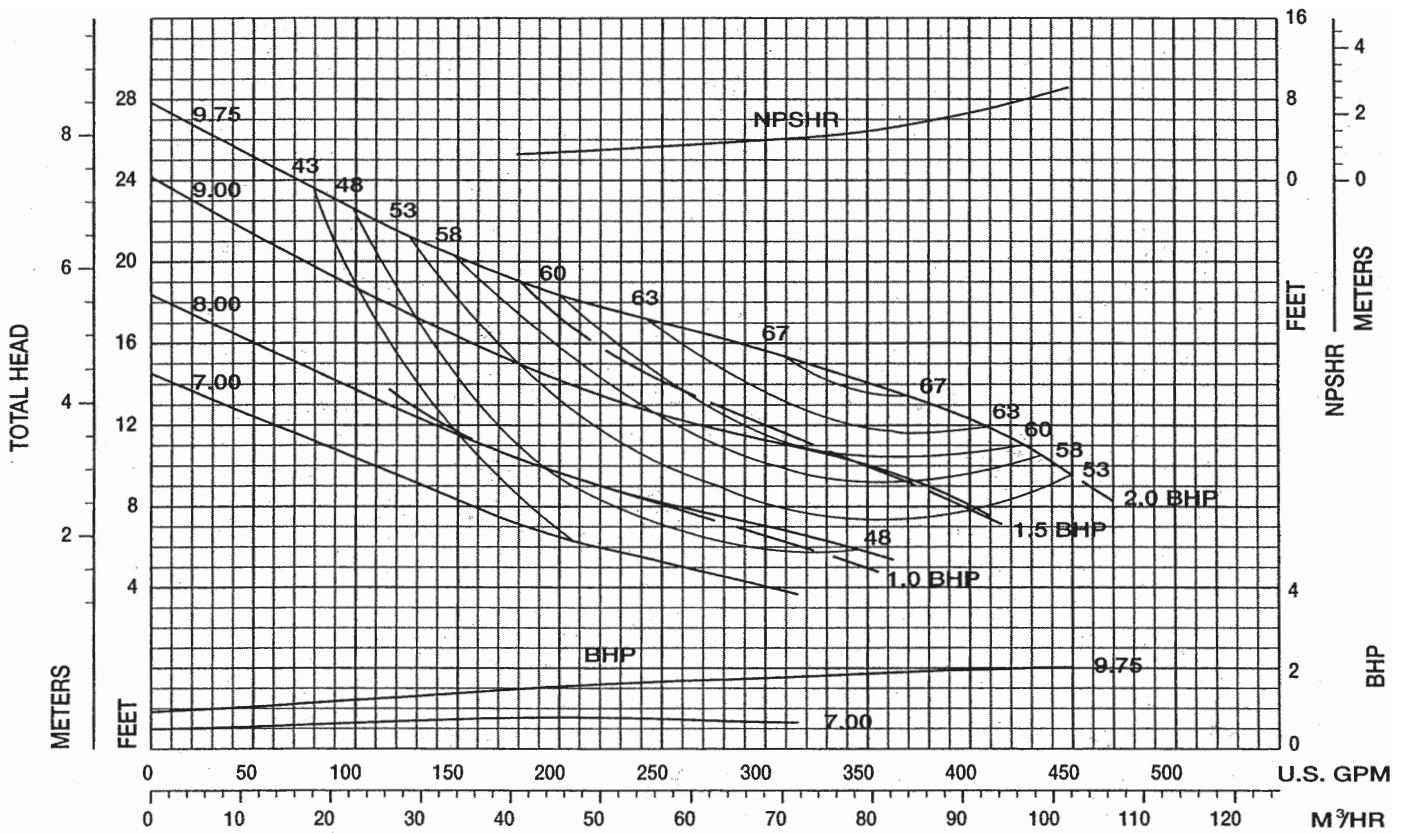

Performance Curve - 4" 5432 MV

RPM: 855 SOLIDS: 3"

IMPELLER: T4B1A, 2 VANE SUCTION: 4" INLET: 26.22 in²

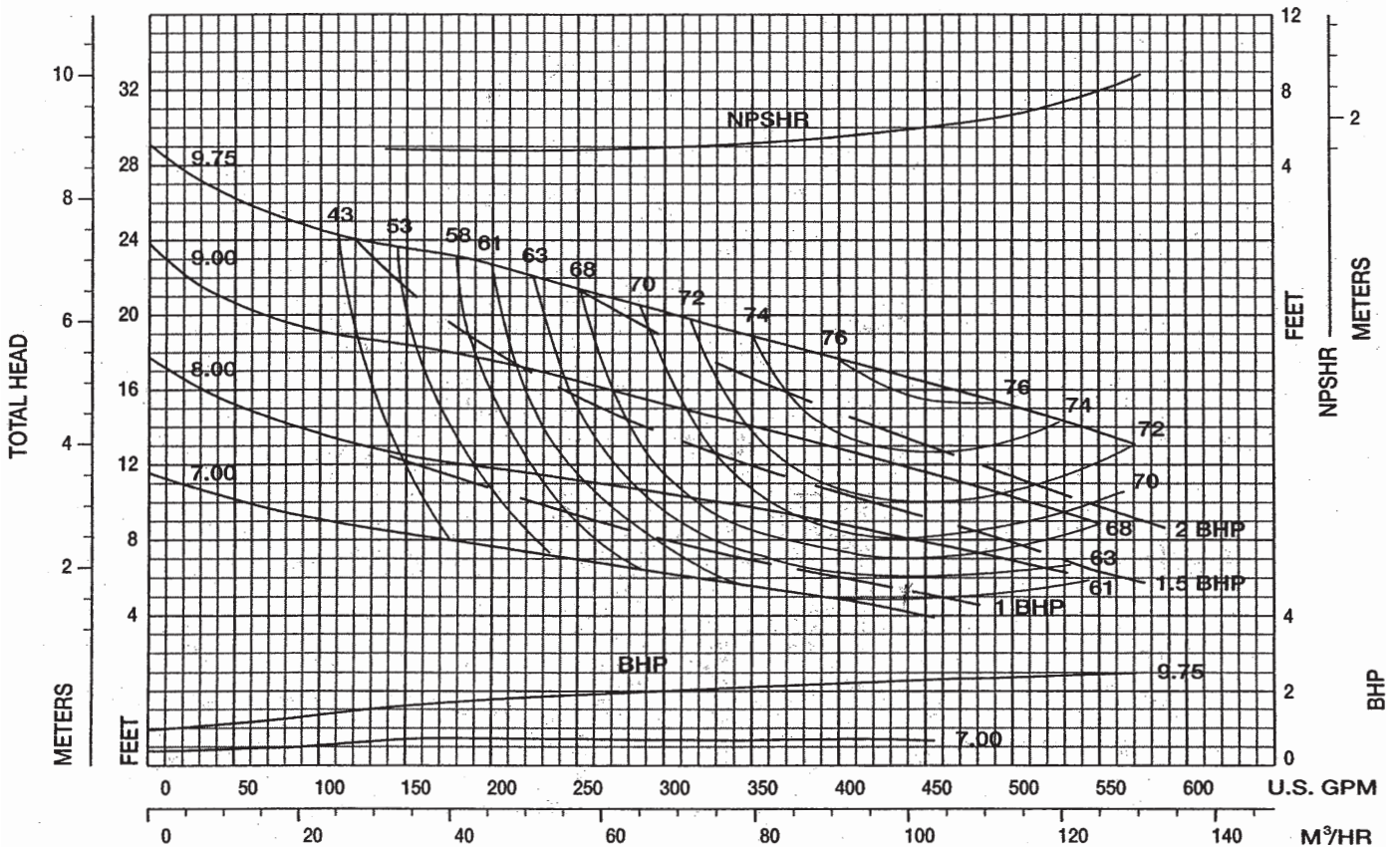

Performance Curve – 3" 5433 MTK, MVK, WK, WDK

RPM: **870** SOLIDS: 2"

IMPELLER: T3C1T, BLADELESS SUCTION: 3" (WDK: 3" or 4") INLET: 11.77 in²

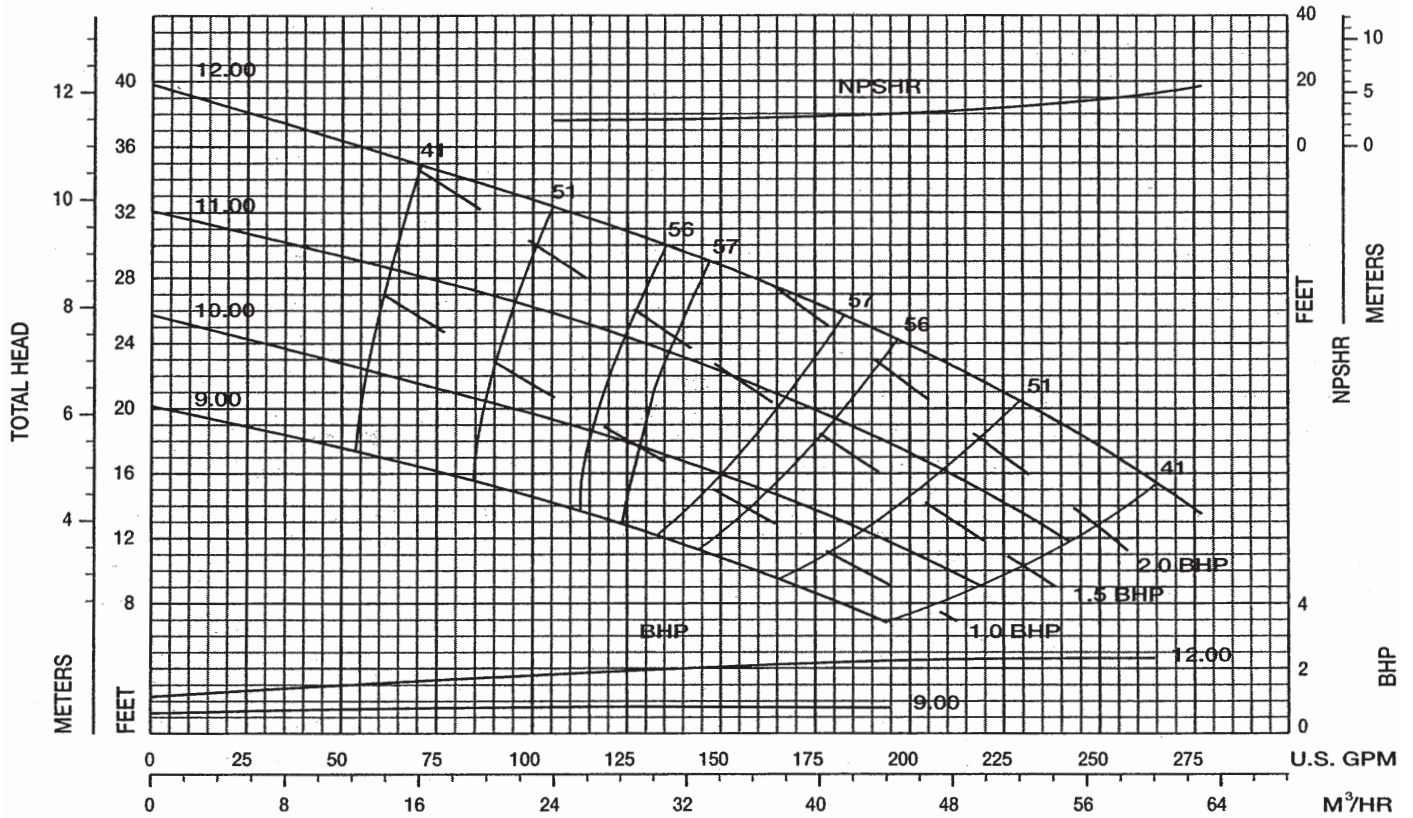

Performance Curve – 3" 5433 MT, MV, W, WD

RPM: **865** SOLIDS: 2"

IMPELLER: T3C1A, 2 VANE SUCTION: 3" (WD: 3" or 4") INLET: 23.52 in²

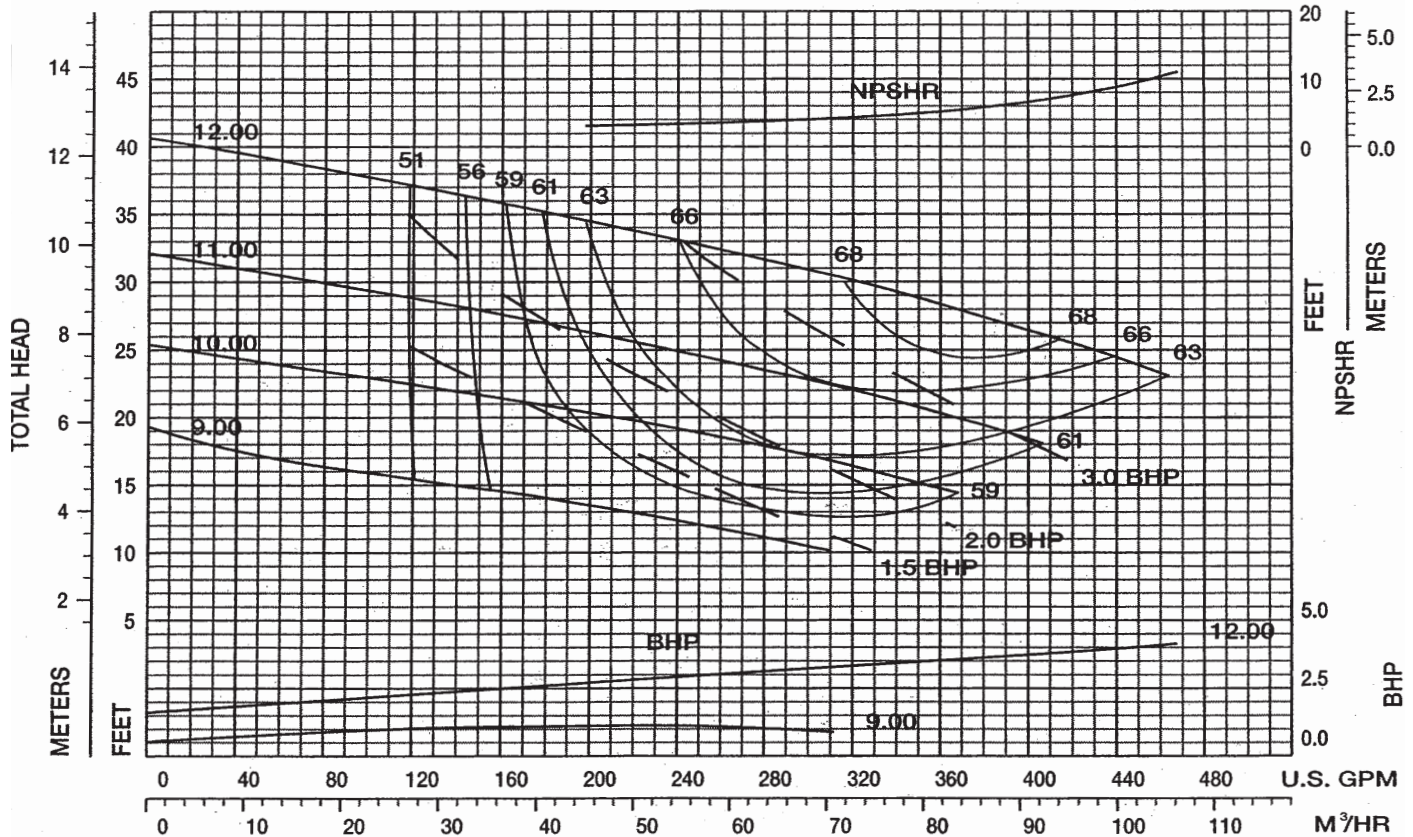

Performance Curve – 4" 5433 MTK, WK, WDK, CWDK

RPM: **865** SOLIDS: **3"**

IMPELLER: **T4C1AA, BLADELESS** SUCTION: **4" (WDK: 4" or 6")** INLET: **23.77 in²**

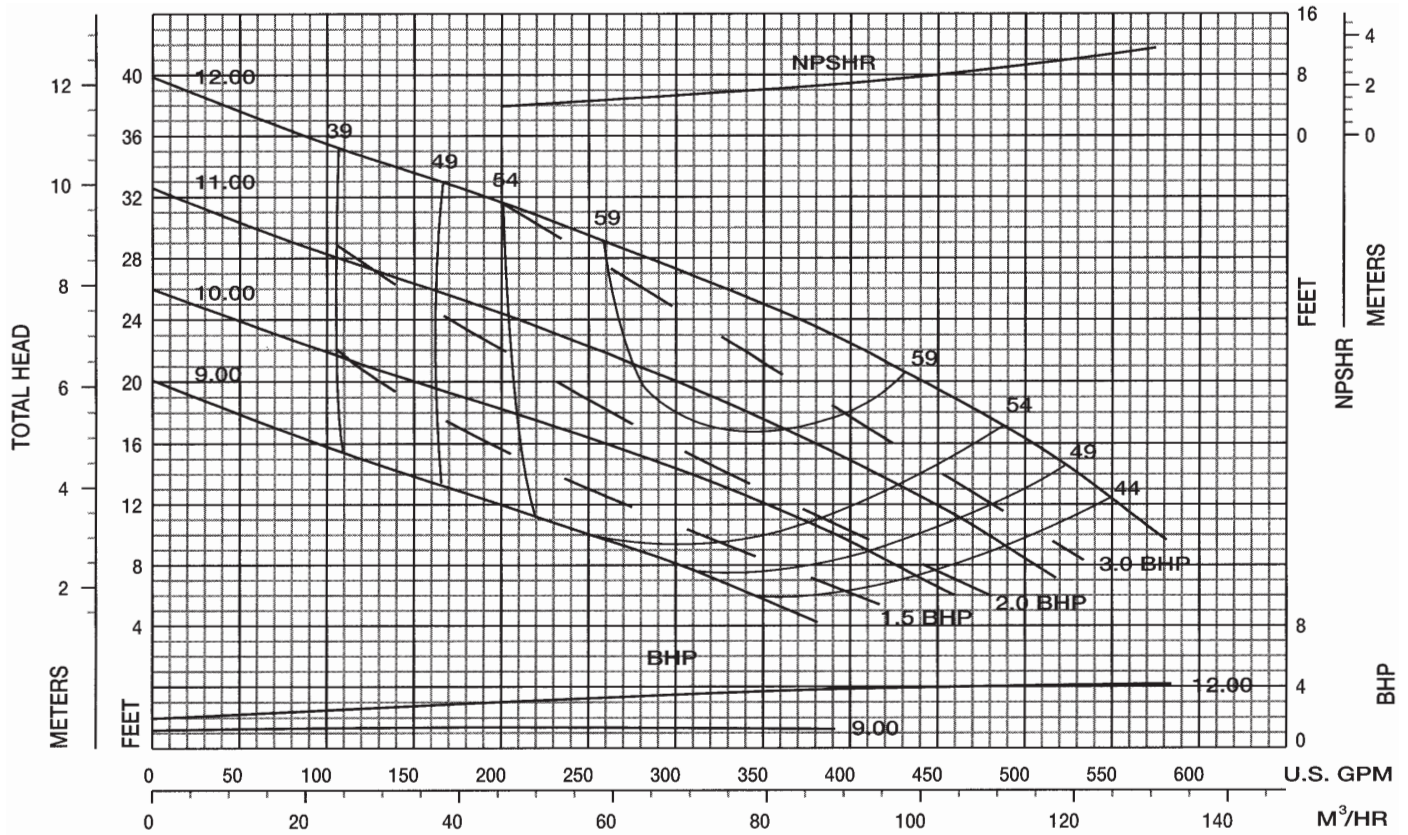

Performance Curve – 4" 5433 MT, W, WD, CWD

RPM: **855** SOLIDS: **3"**

IMPELLER: **T4C1A, 2 VANE** SUCTION: **4" (WD: 4" or 6")** INLET: **26.22 in²**

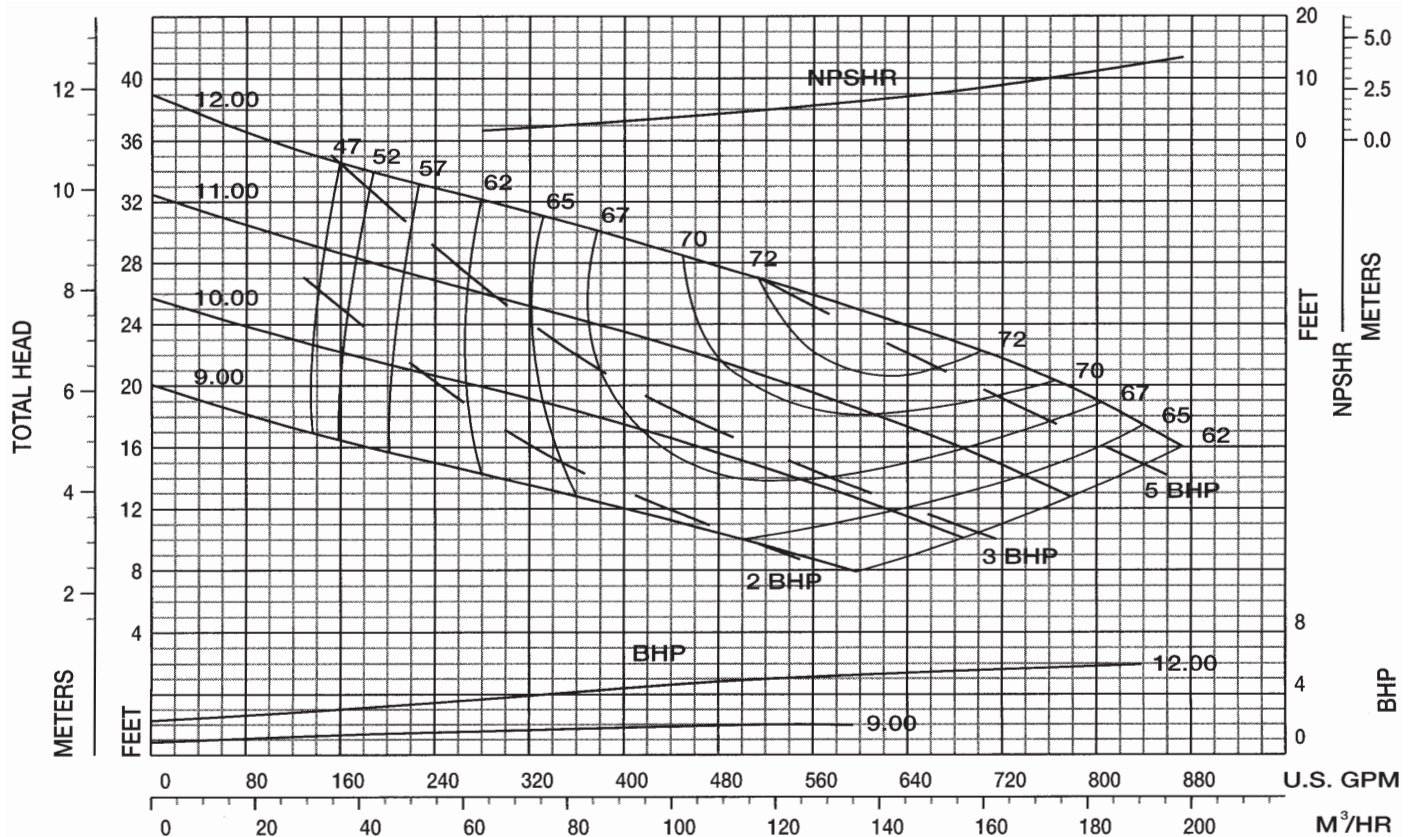

Performance Curve - 4" 5433 MVK

RPM: **875** SOLIDS: **3"**

IMPELLER: **T4C1AA, BLADELESS** SUCTION: **4"** INLET: **23.77 in²**

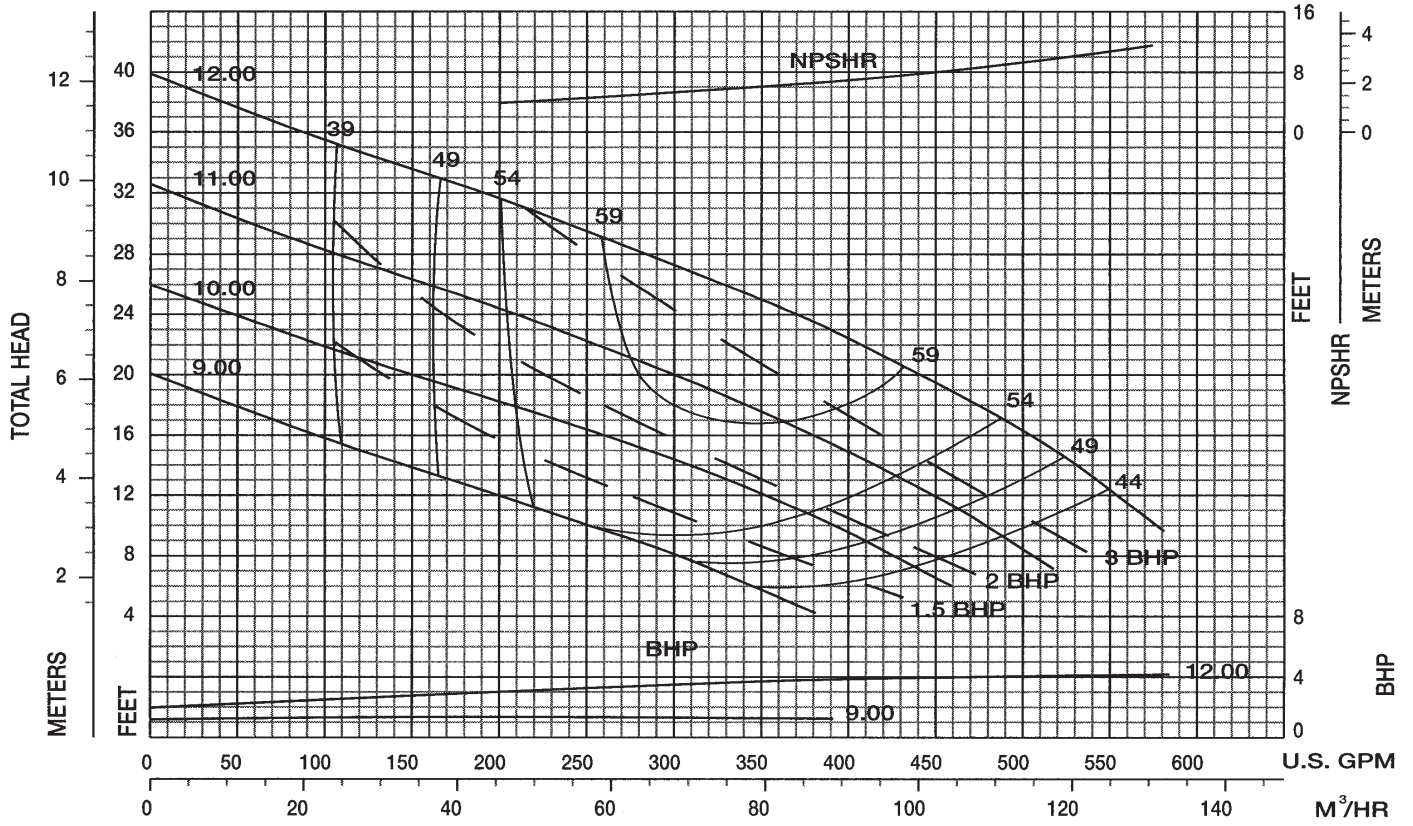

Performance Curve - 4" 5433 MV

RPM: **855** SOLIDS: **3"**

IMPELLER: **T4C1A, 2 VANE** SUCTION: **4"** INLET: **26.22 in²**

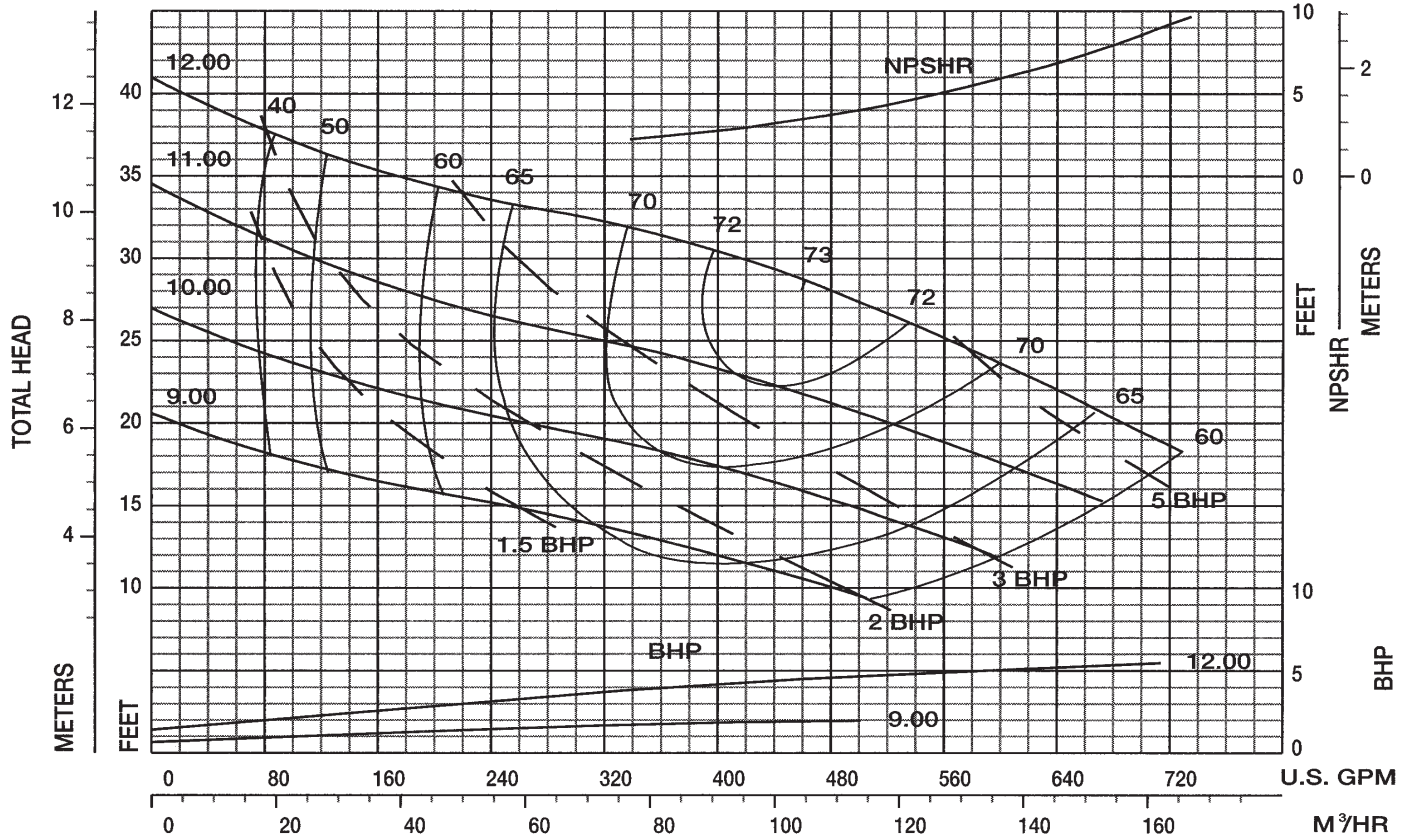

Performance Curve - 4" 5433 MV

RPM: 885 SOLIDS: 3"

IMPELLER: T4B1NA, 2 VANE SUCTION: 4" INLET: 26.22 in²

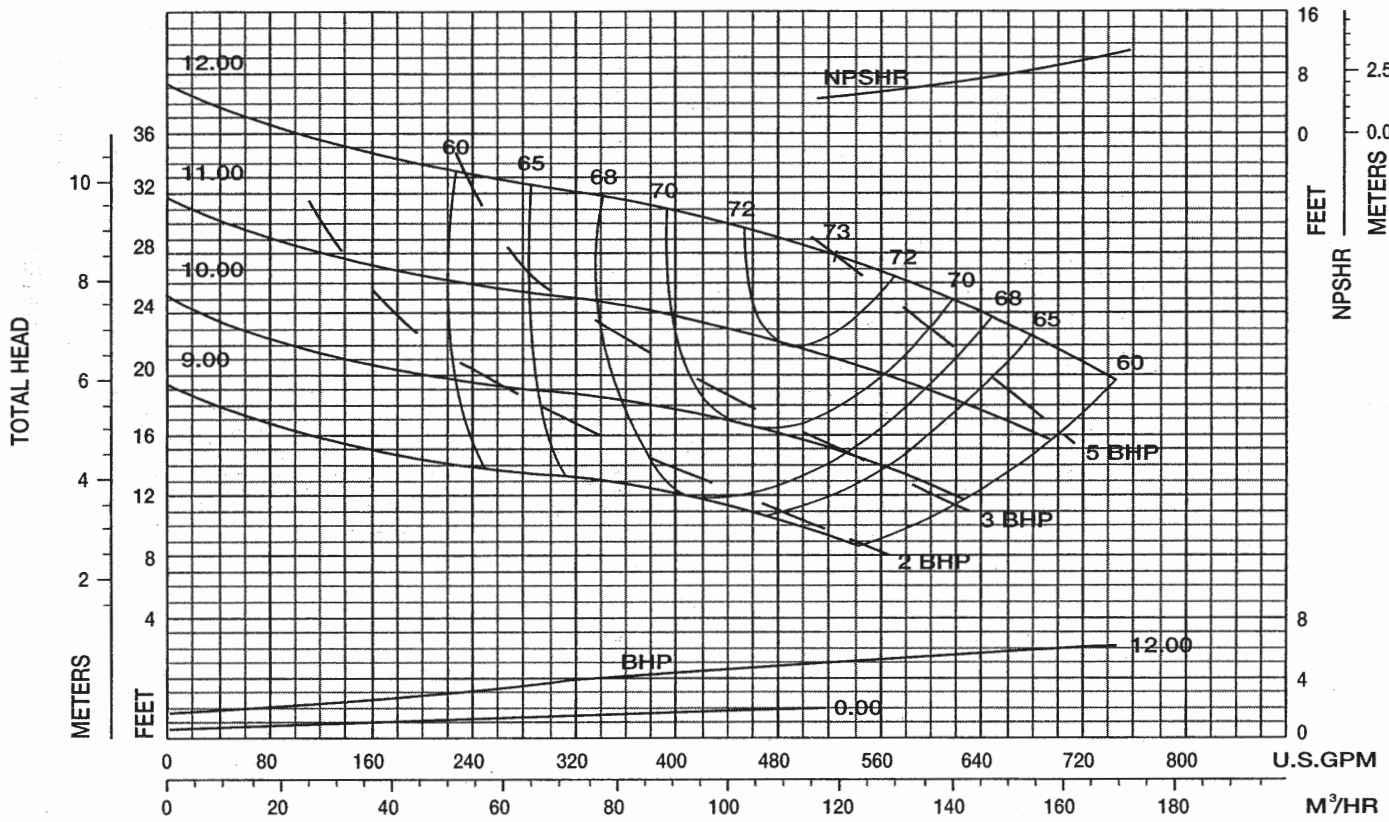

Performance Curve - 5" 5433 MVK, MTK, WK, WDK

RPM: 865 SOLIDS: 3-1/2"

IMPELLER: T5C1AG, BLADELESS SUCTION: 5" (WDK: 5" or 6") INLET: 37.69 in²

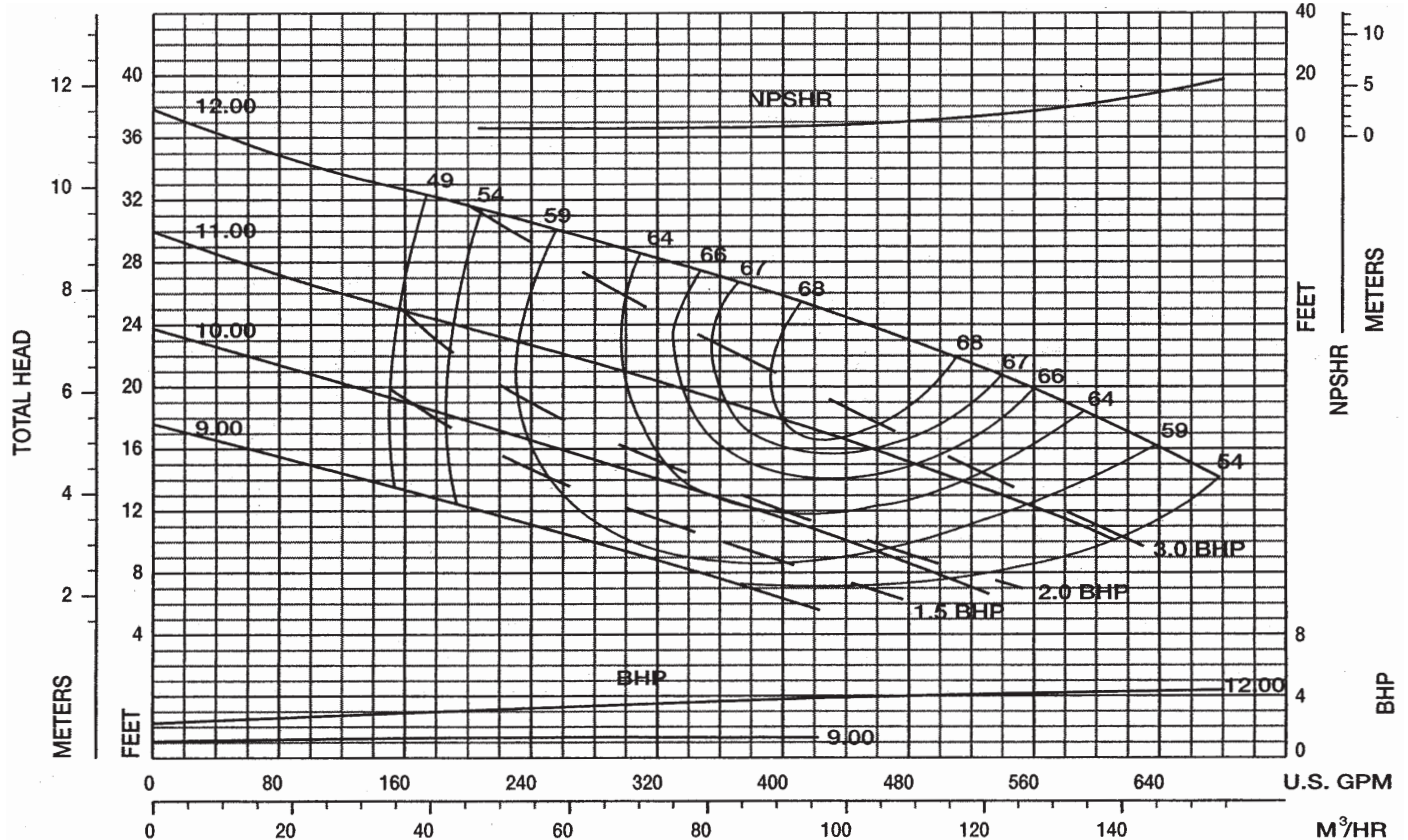

Performance Curve - 6" 5433 MT, W, WD

RPM: 865 SOLIDS: 3"

IMPELLER: T6C1C, 2 VANE SUCTION: 6" (WD: 6" or 8") INLET: 52.88 in²

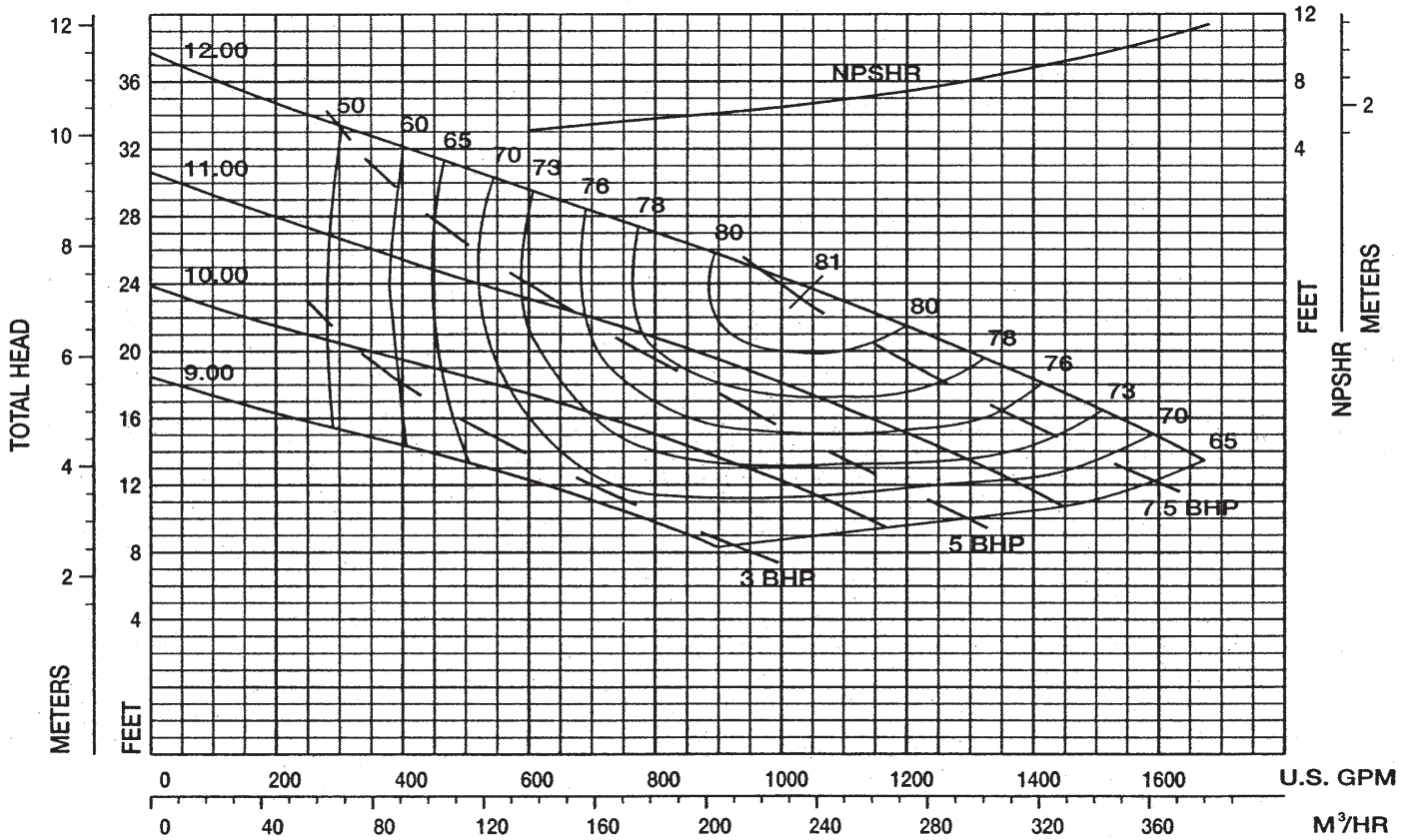

Performance Curve - 6" 5433 MV

RPM: 855 SOLIDS: 3"

IMPELLER: T6C1C, 2 VANE SUCTION: 6" INLET: 52.88 in²

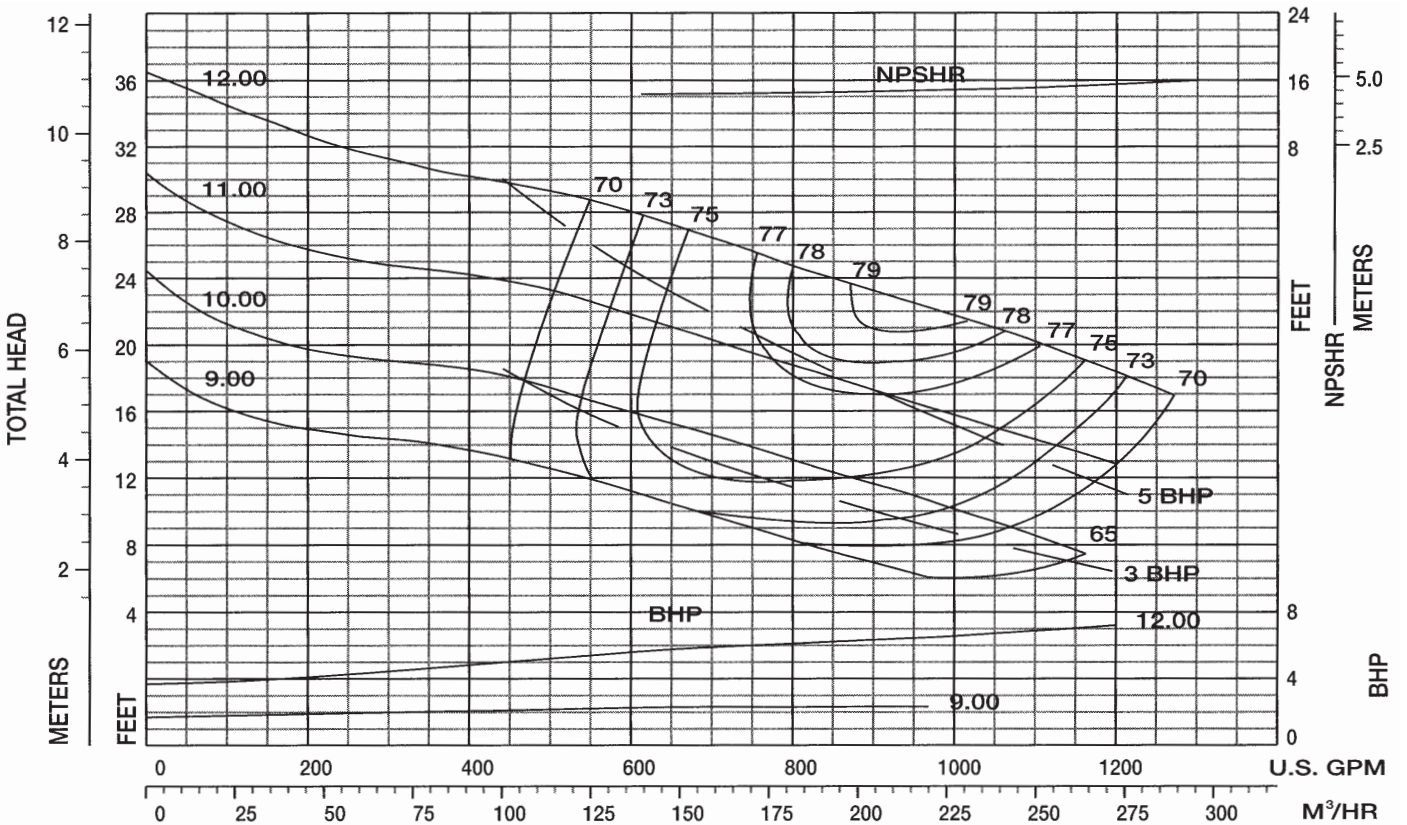

Performance Curve - 4" 5434 MT, W, WD

RPM: 865 SOLIDS: 3"

IMPELLER: T4D1B, 2 VANE SUCTION: 5" (WD: 5", 6" or 8") INLET: 47.01 in²

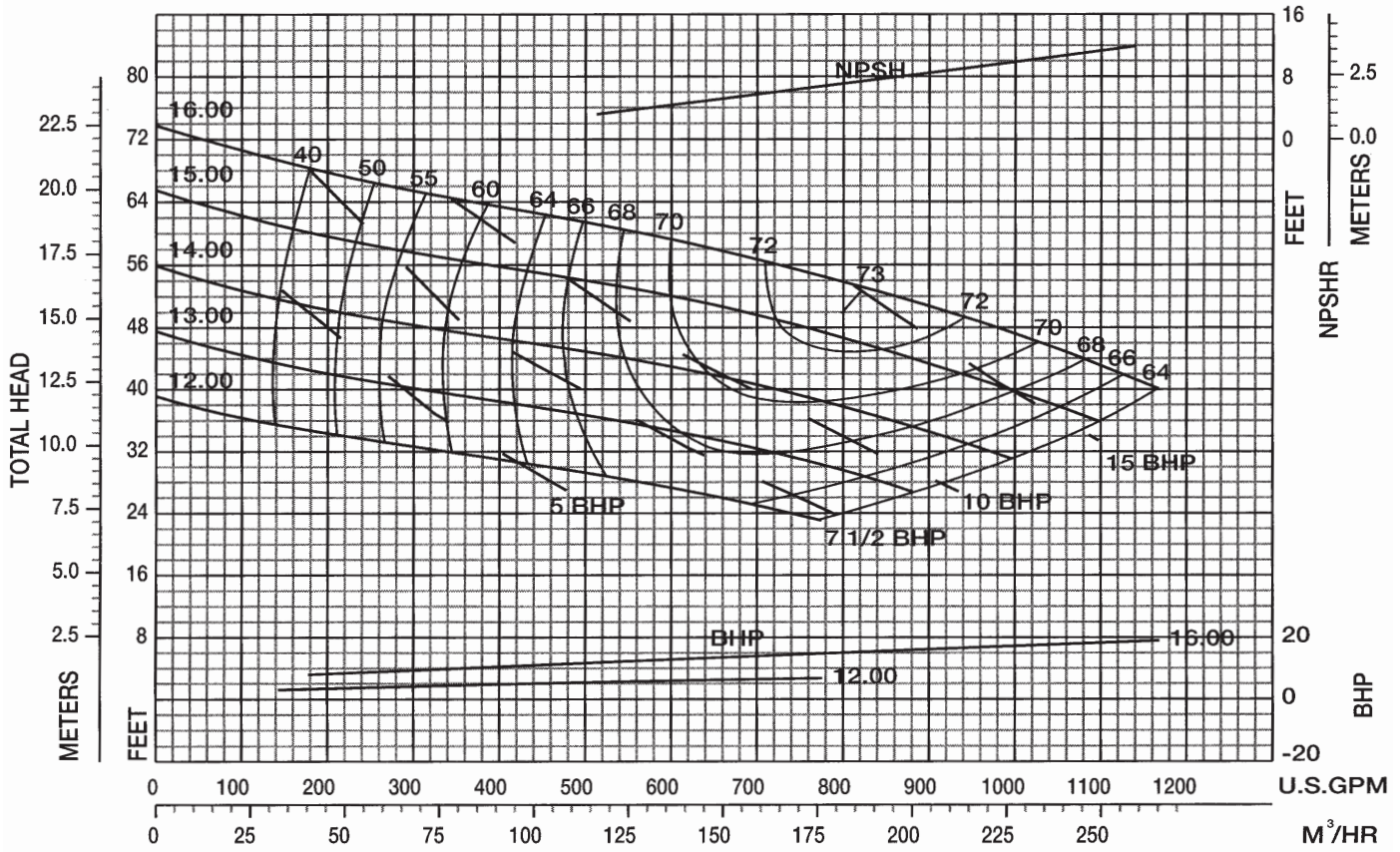

Performance Curve - 4" 5434 MV

RPM: 865 SOLIDS: 3"

IMPELLER: T4D1B, 2 VANE SUCTION: 4" INLET: 47.01 in²

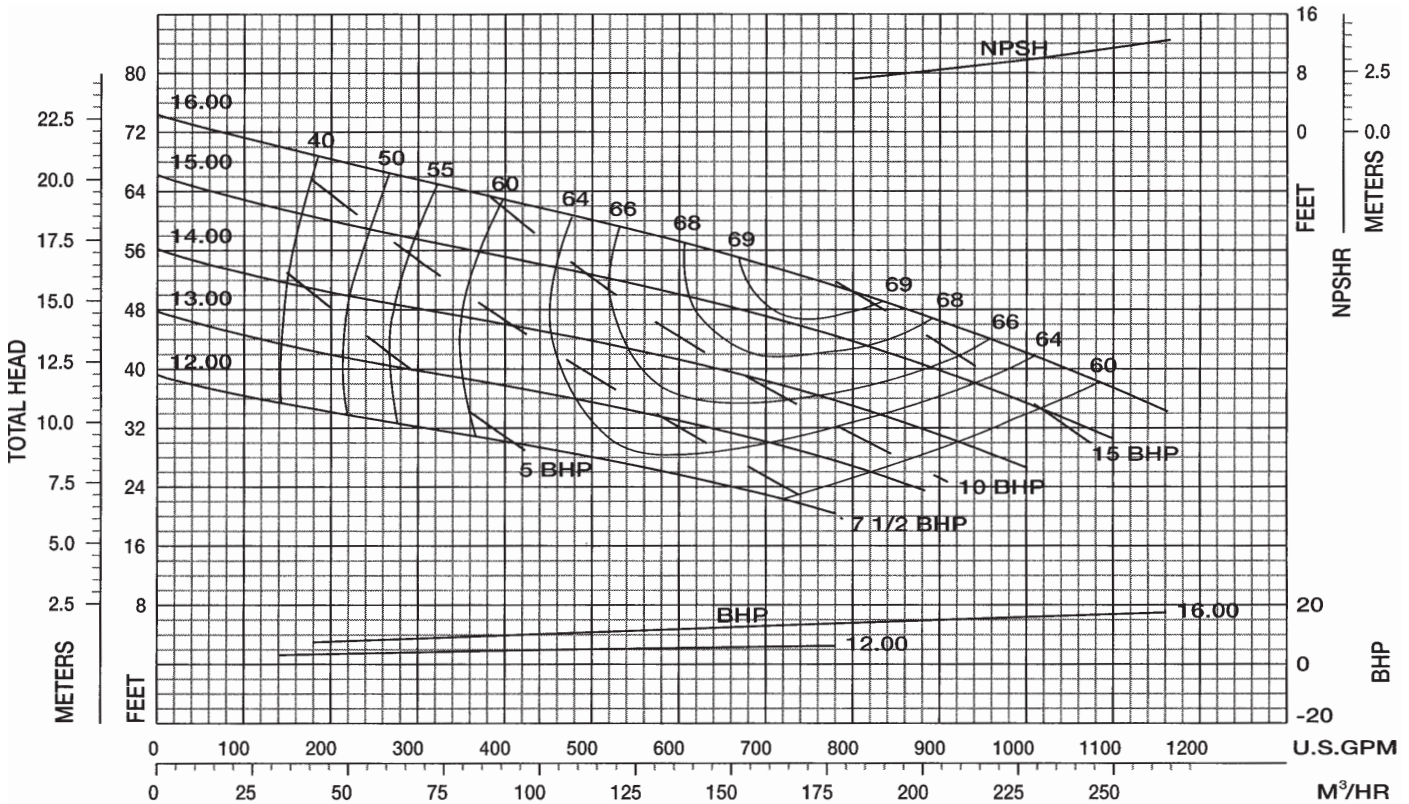

Performance Curve – 5" 5434 MT, W, WD

RPM: **880** SOLIDS: **4"**

IMPELLER: **T5D1A, 2 VANE** SUCTION: **5" (WD: 5", 6" or 8")** INLET: **58.39 in²**

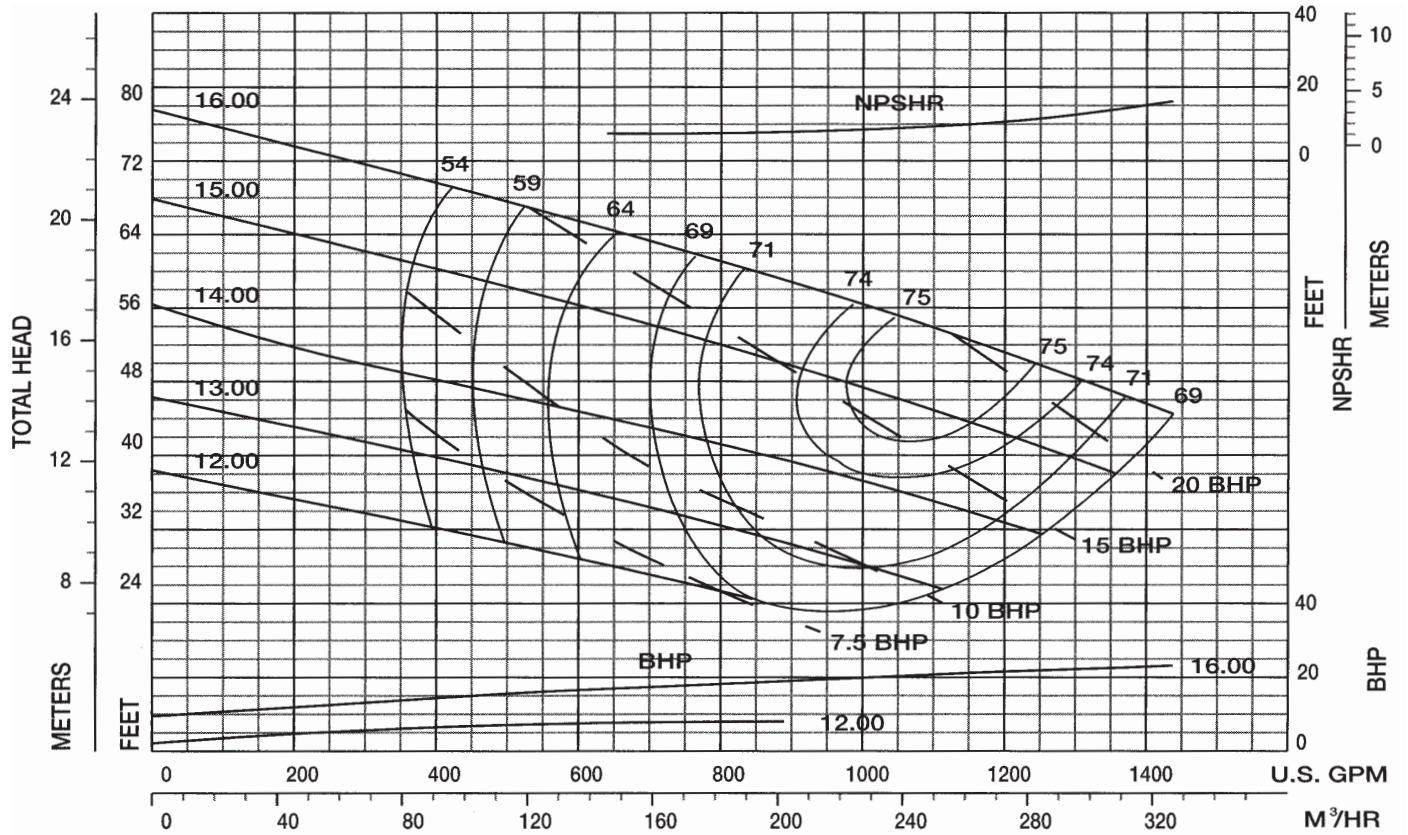

Performance Curve – 6" 5434 MTK, WK, WDK

RPM: **865** SOLIDS: **4"**

IMPELLER: **T6D1A, BLADELESS** SUCTION: **6" (WDK: 6" or 8")** INLET: **36.42 in²**

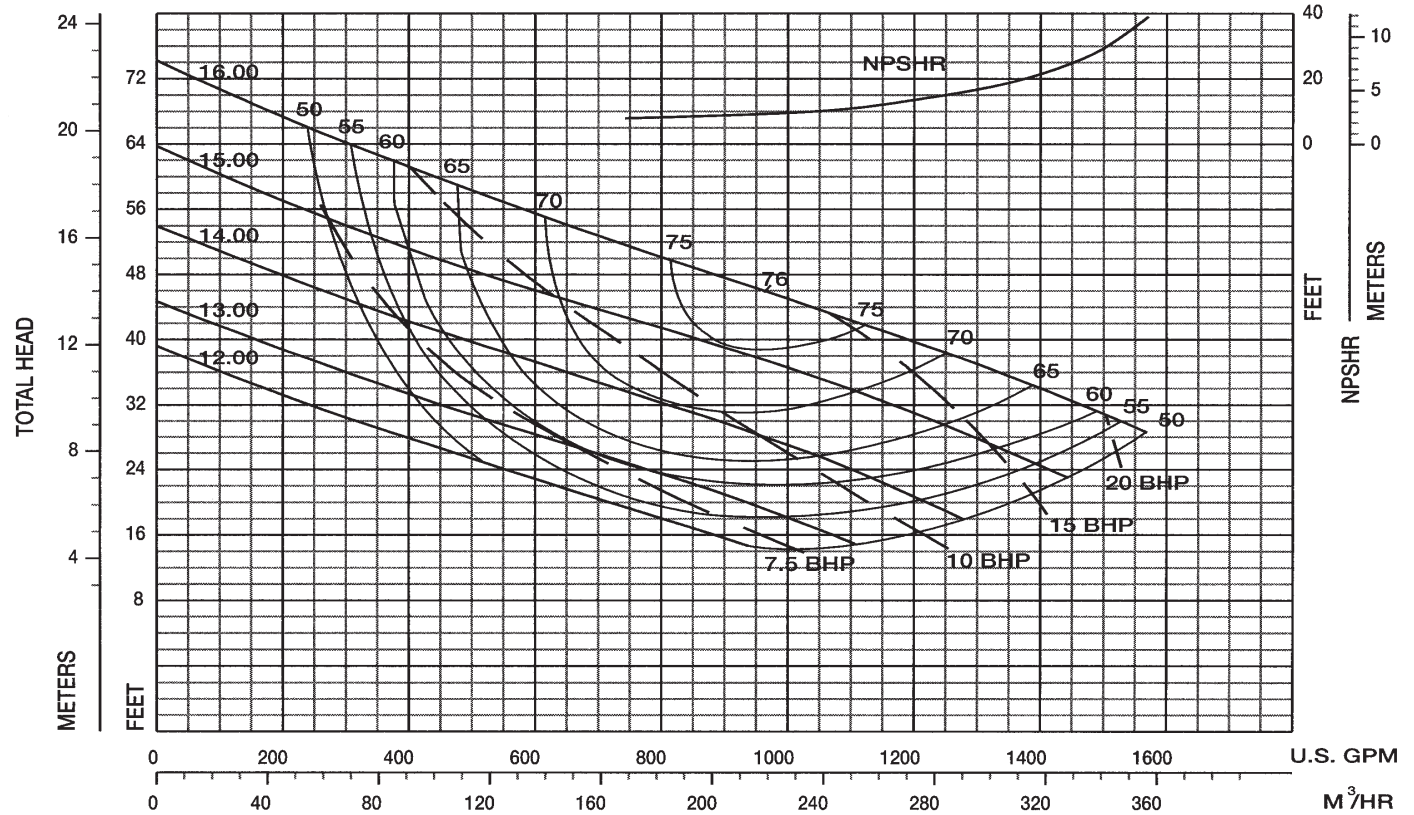

Performance Curve – 6" 5434 MT, W, WD

RPM: **880** SOLIDS: **3"**

IMPELLER: **TAJC5BH, 3 VANE** SUCTION: **6" (WD: 6" or 8")** INLET: **60.58 in²**

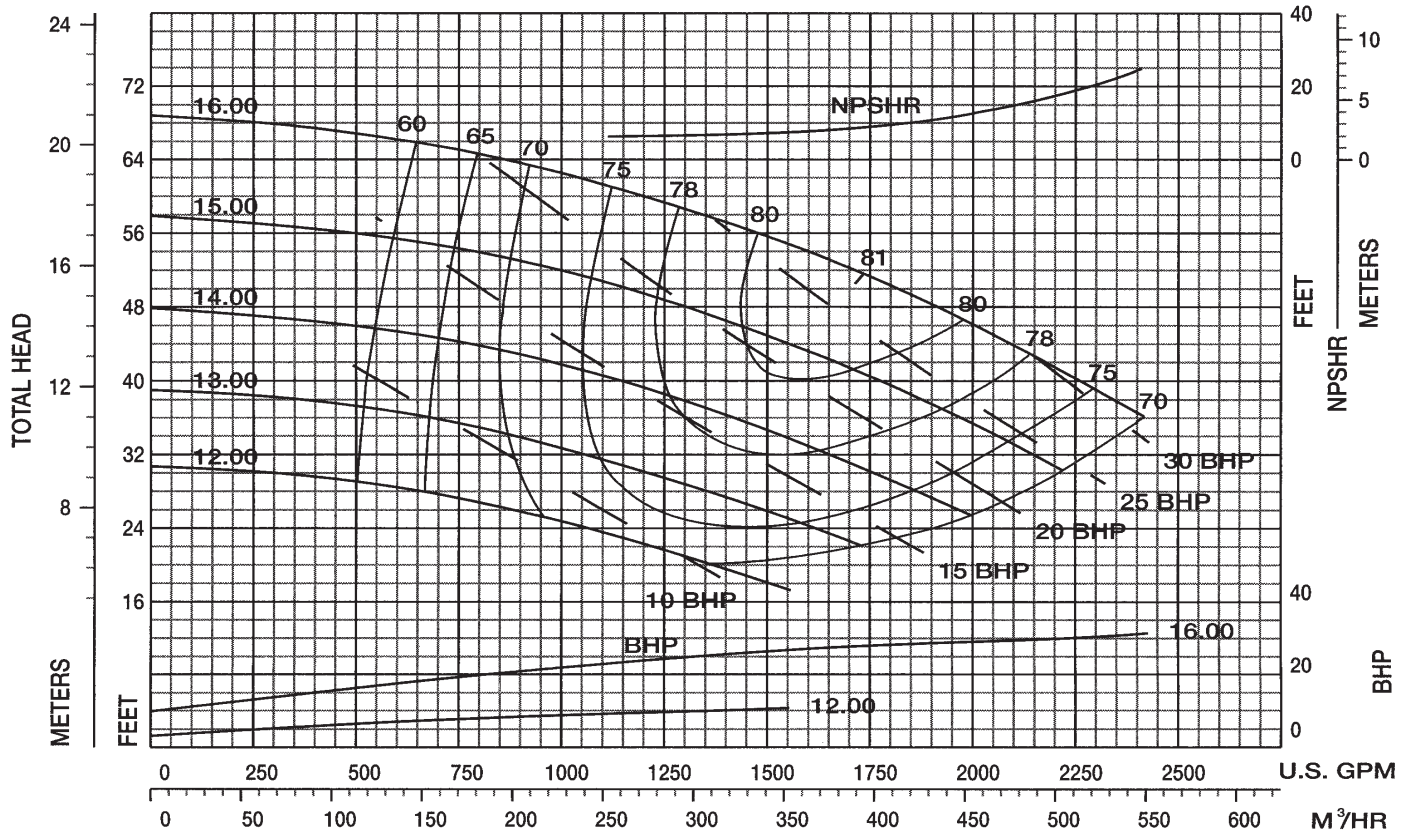

Performance Curve – 6" 5434 MT, W, WD

RPM: **880** SOLIDS: **4"**

IMPELLER: **TAJC5DC, 2 VANE** SUCTION: **6" (WD: 6" or 8")** INLET: **70.85 in²**

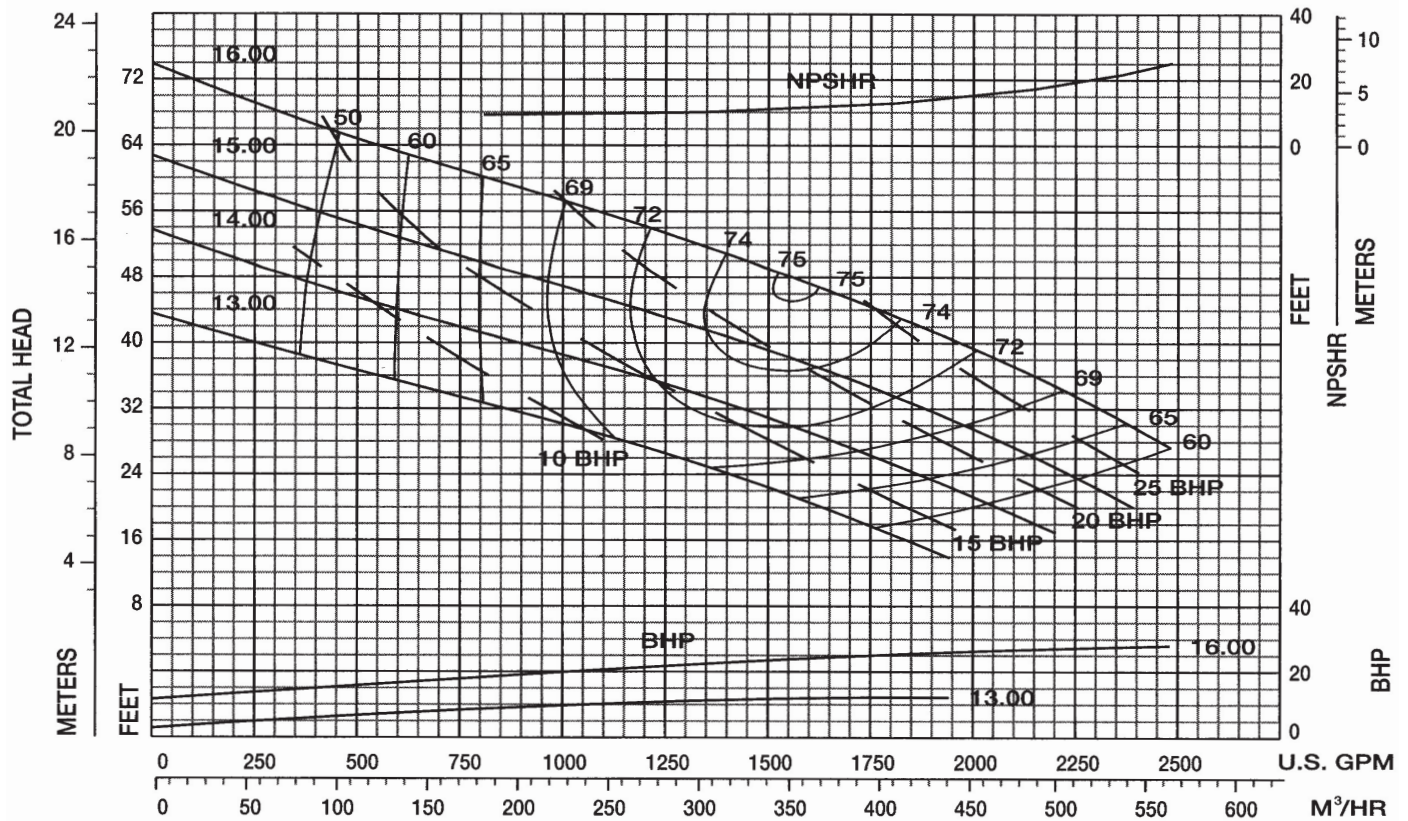

Performance Curve – 6" 5434 MT, W, WD

RPM: **865** SOLIDS: **3"**

IMPELLER: **TAJC5BJ, 3 VANE** SUCTION: **6" (WD: 6" or 8")** INLET: **64.55 in²**

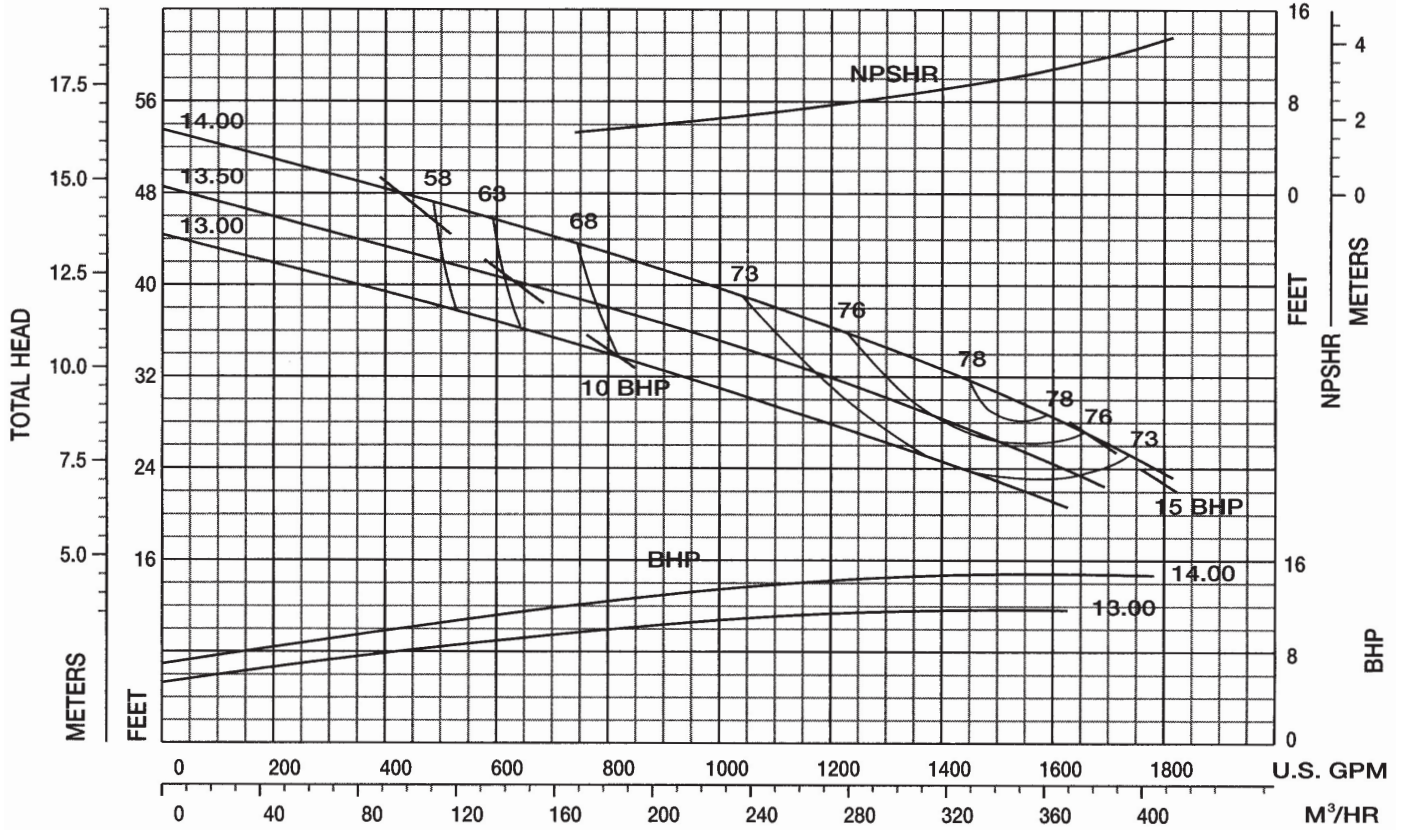

Performance Curve – 6" 5434 MV

RPM: **880** SOLIDS: **3"**

IMPELLER: **TAJC5BH, 3 VANE** SUCTION: **6"** INLET: **60.58 in²**

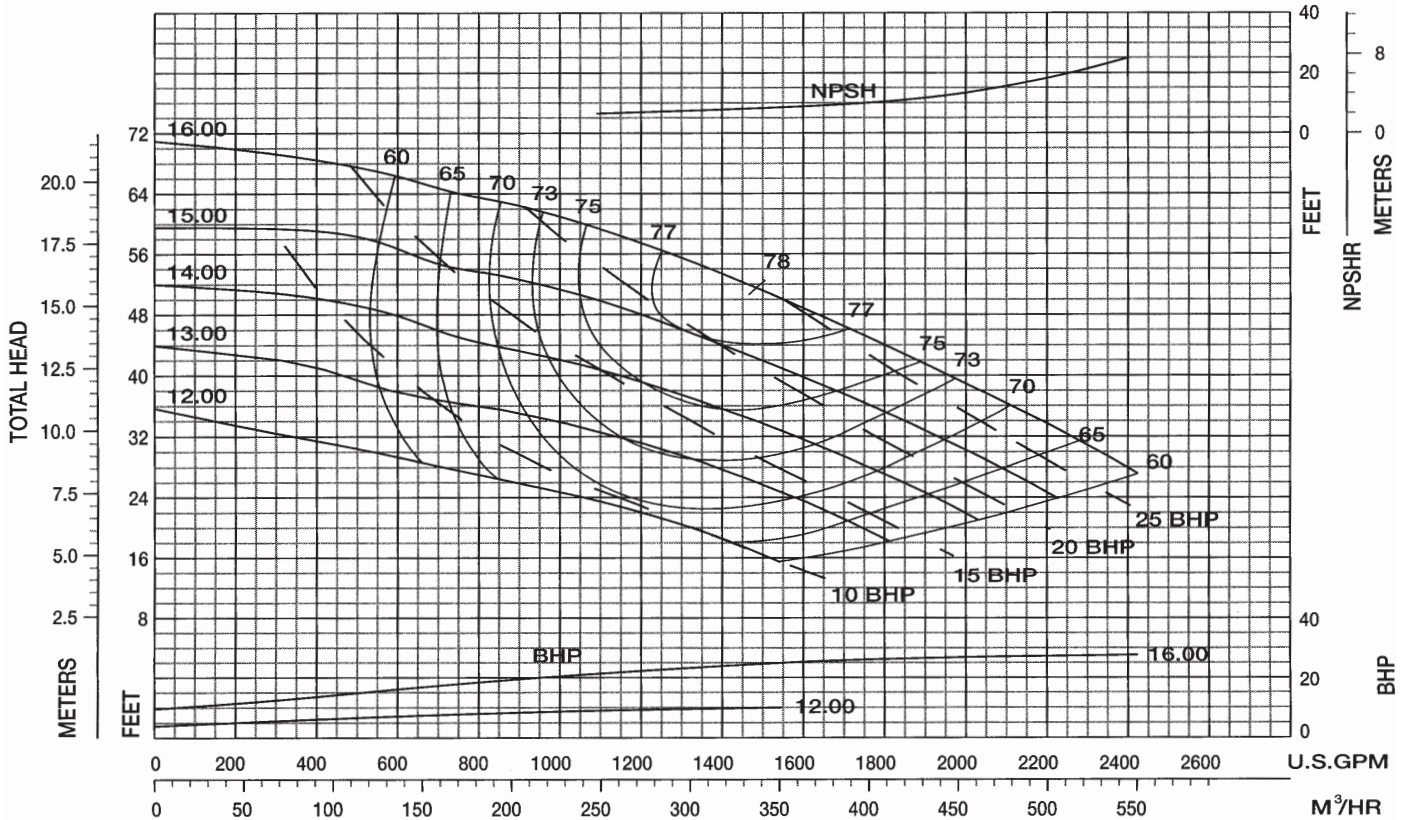

Performance Curve – 6" 5434 MV

RPM: **880** SOLIDS: **4"**

IMPELLER: **TAJC5DC, 2 VANE** SUCTION: **6"** INLET: **70.85 in²**

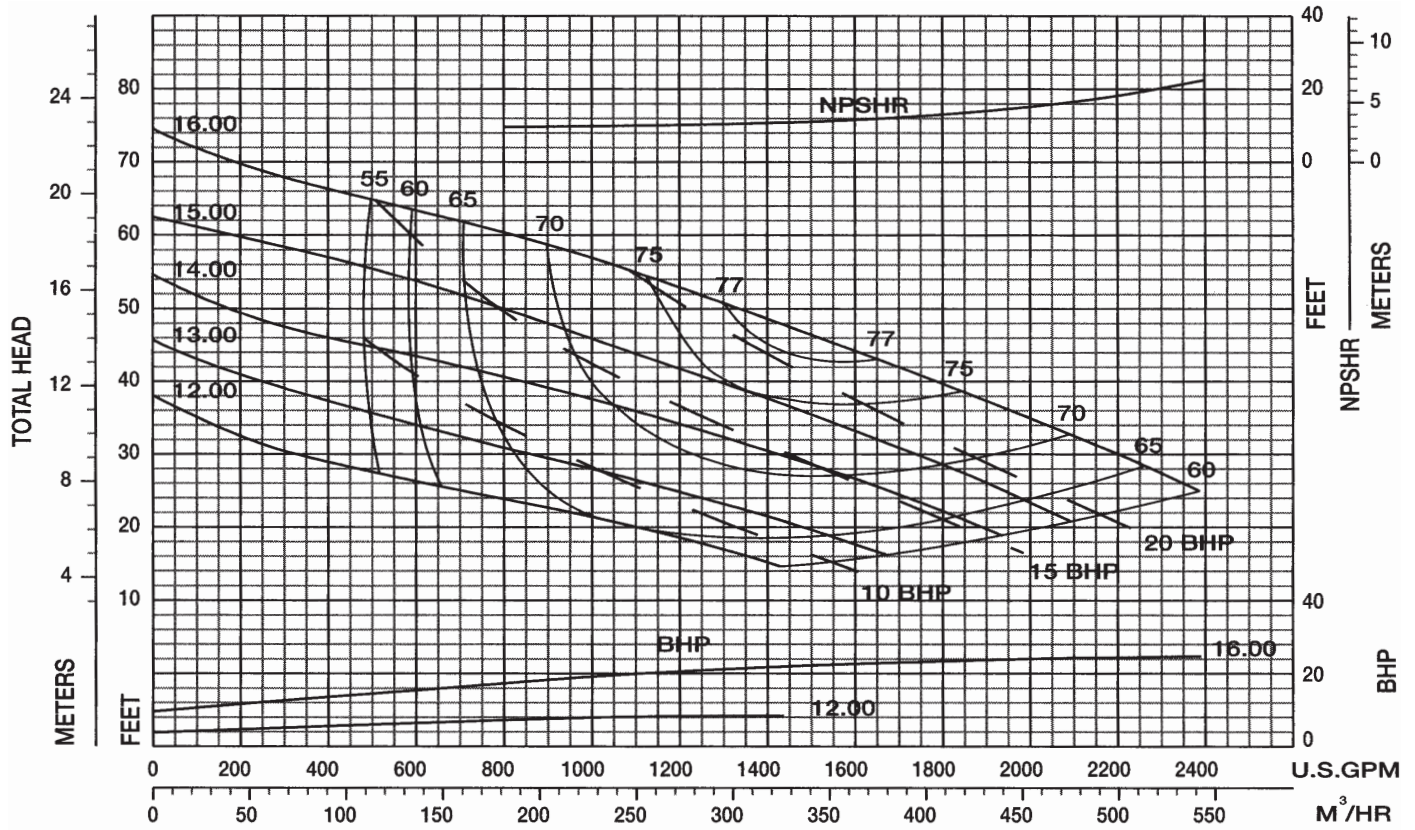

Performance Curve – 6" 5434 MV

RPM: **865** SOLIDS: **3"**

IMPELLER: **TAJC5BJ, 3 VANE** SUCTION: **6"** INLET: **64.55 in²**

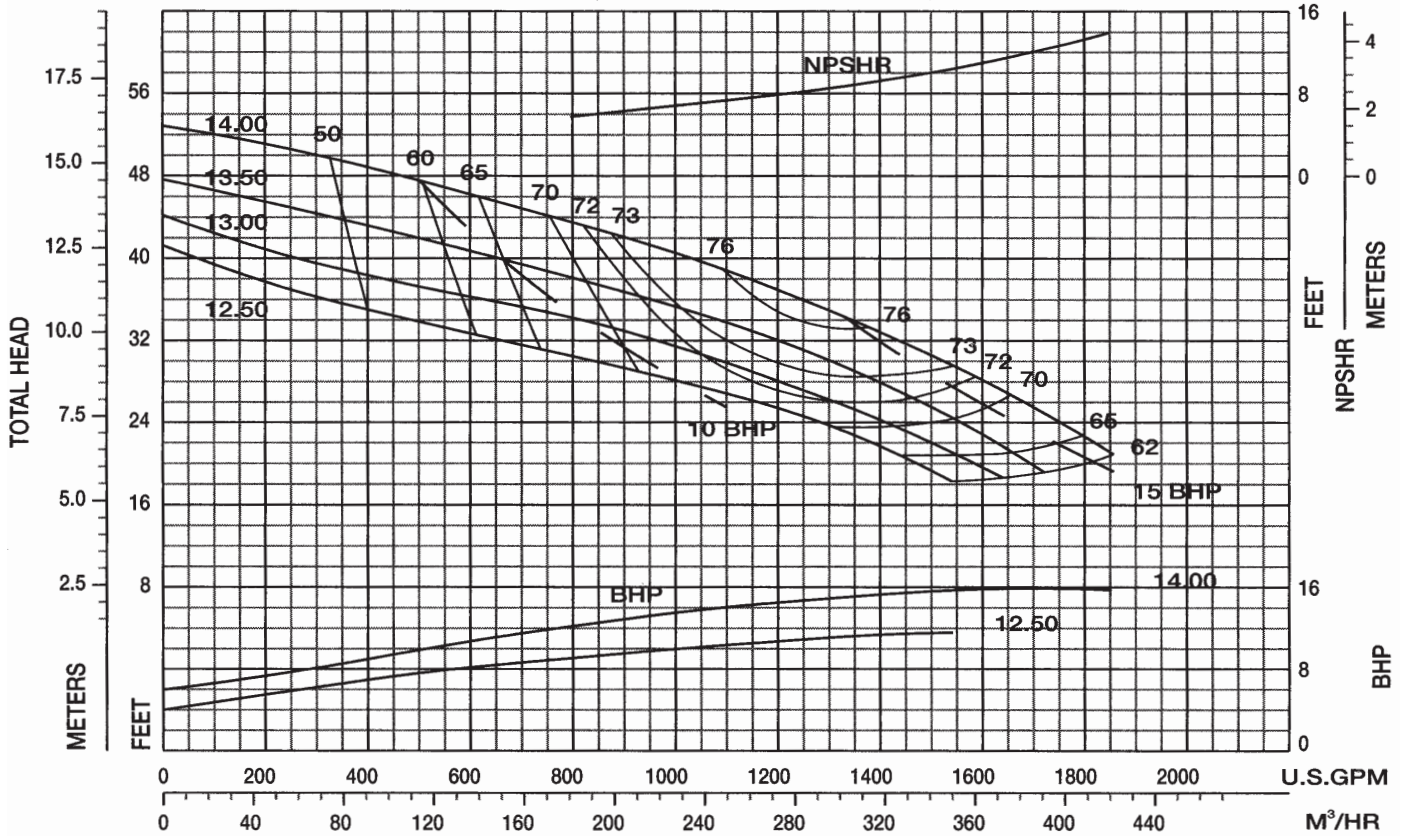

Performance Curve – 8" 5434S MT, W, WD

RPM: **865** SOLIDS: **3-1/2"**

IMPELLER: **T8D1A, 2 VANE** SUCTION: **10" (WD: 8" or 10")** INLET: **62.99 in²**

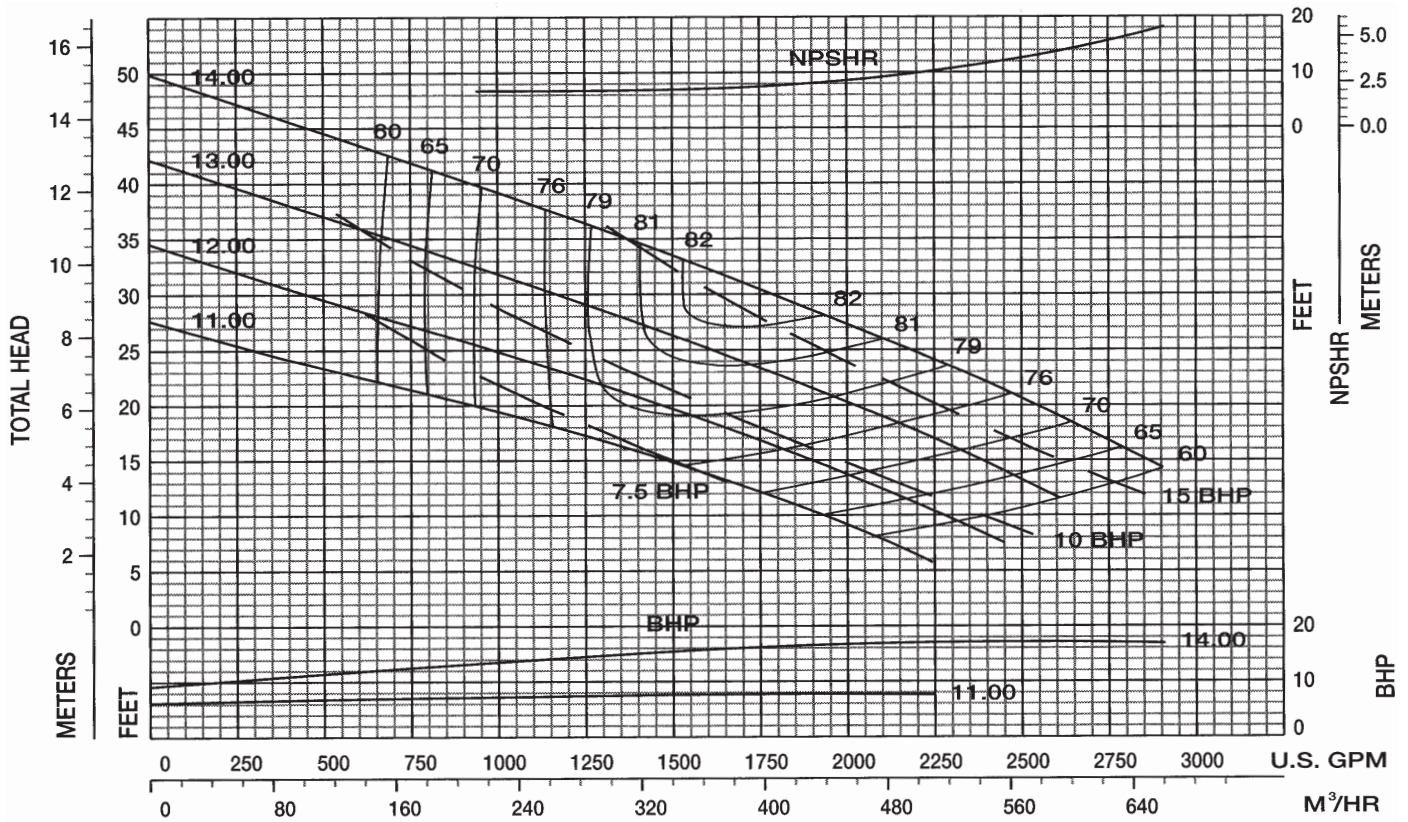

Performance Curve – 8" 5434L MTK, WK, WDK

RPM: **880** SOLIDS: **5"**

IMPELLER: **T8D1G, BLADELESS** SUCTION: **10" (WDK: 8" or 10")** INLET: **50.30 in²**

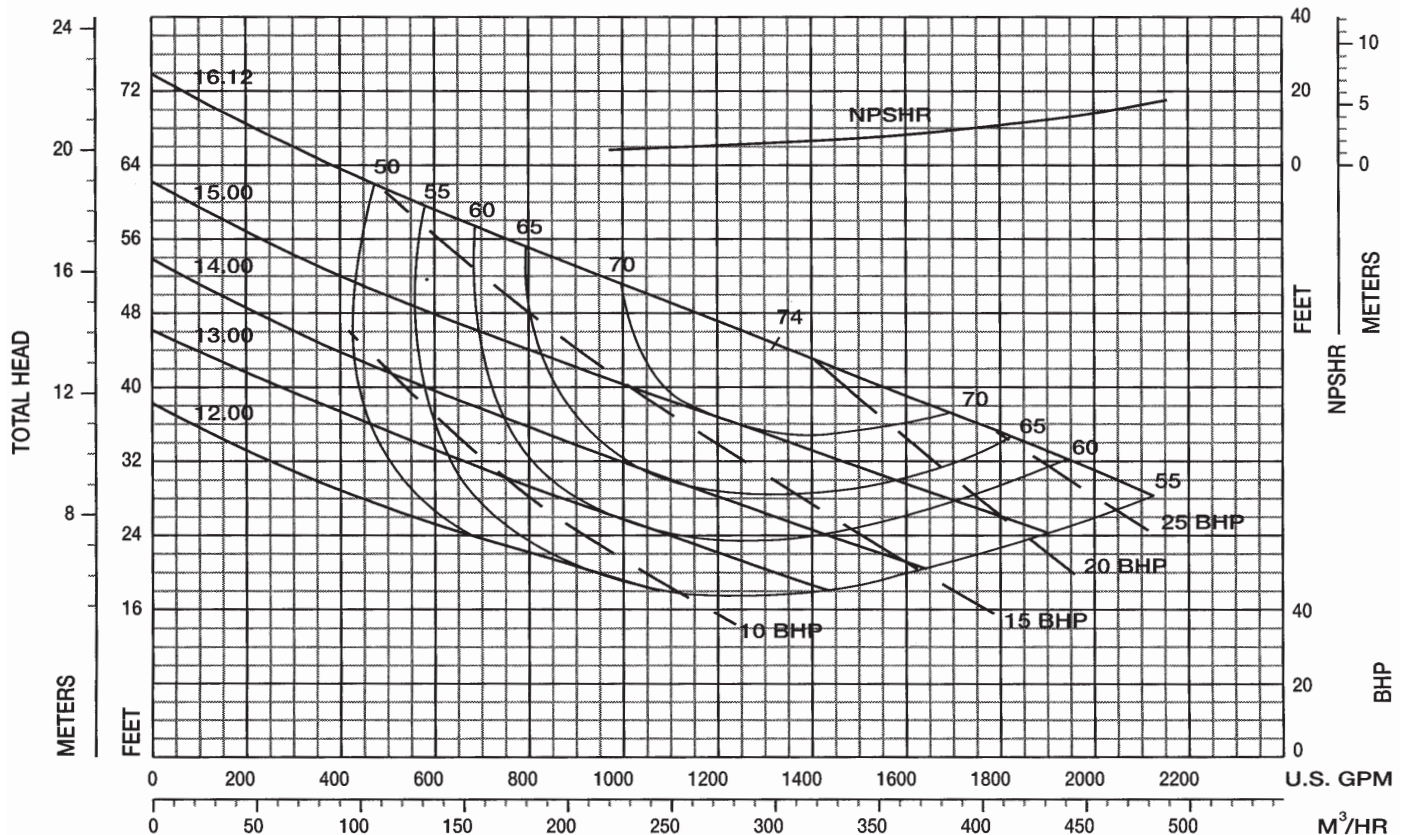

Performance Curve – 8" 5434L MT, W, WD

RPM: **880** SOLIDS: **5"**

IMPELLER: **TAKC5W, 2 VANE** SUCTION: **10" (WD: 8" or 10")** INLET: **99.93 in²**

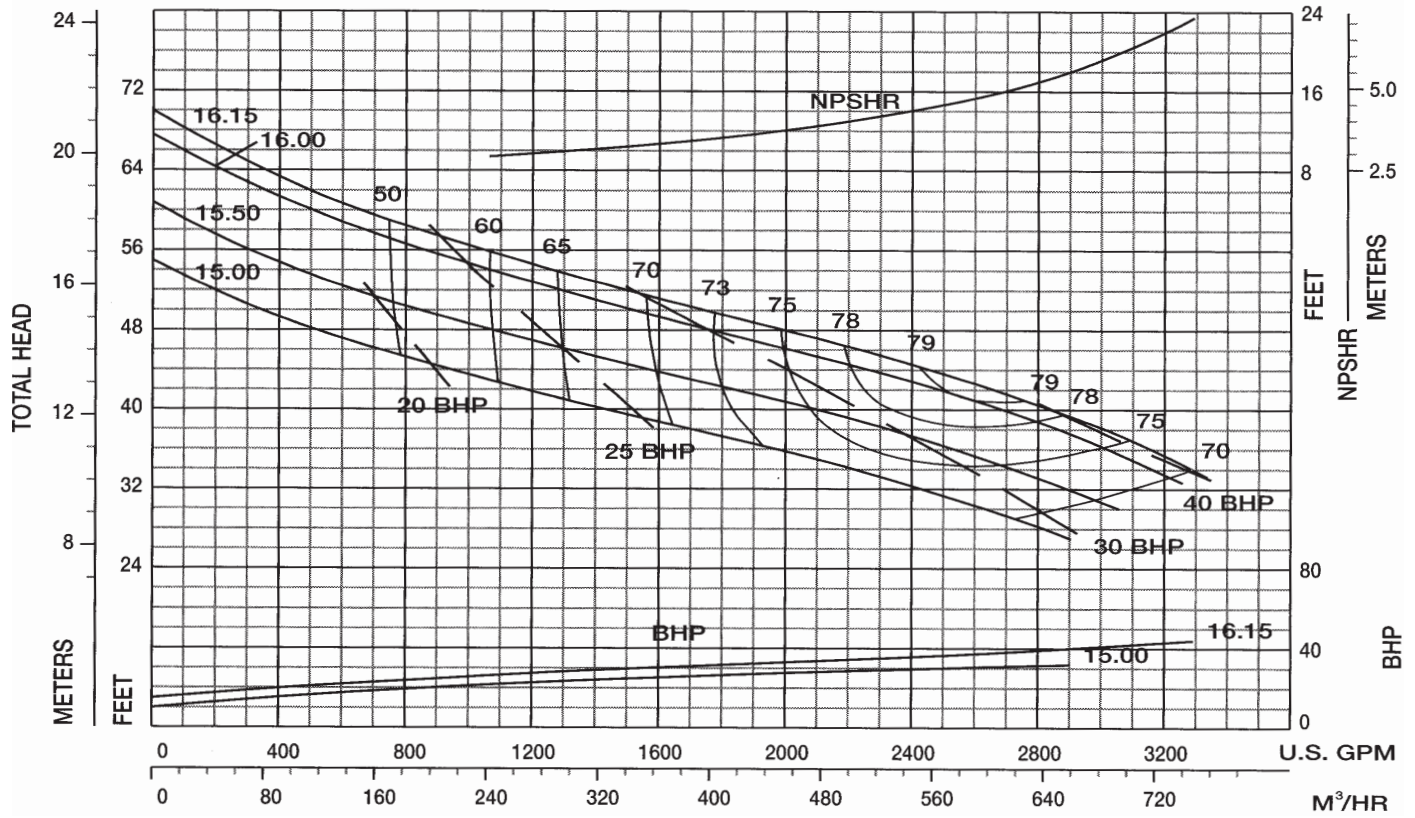

Performance Curve – 8" 5434L MT, W, WD

RPM: **880** SOLIDS: **4"**

IMPELLER: **T8D1D, 2 VANE** SUCTION: **10" (WD: 8" or 10")** INLET: **72.94 in²**

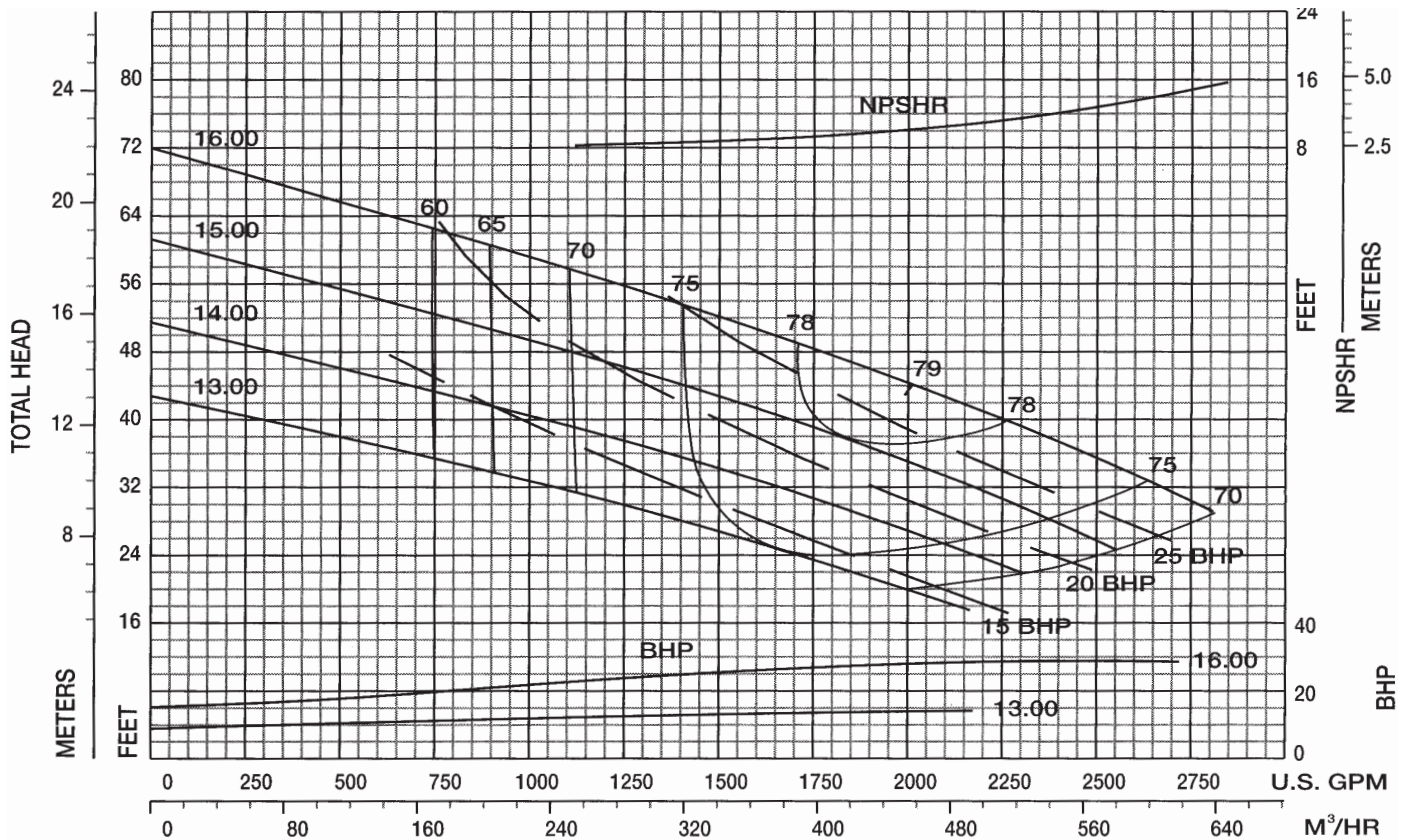

Performance Curve – 8" 5434S MV

RPM: **880** SOLIDS: **3-1/2"**

IMPELLER: **T8D1A, 2 VANE** SUCTION: **10"** INLET: **62.99 in²**

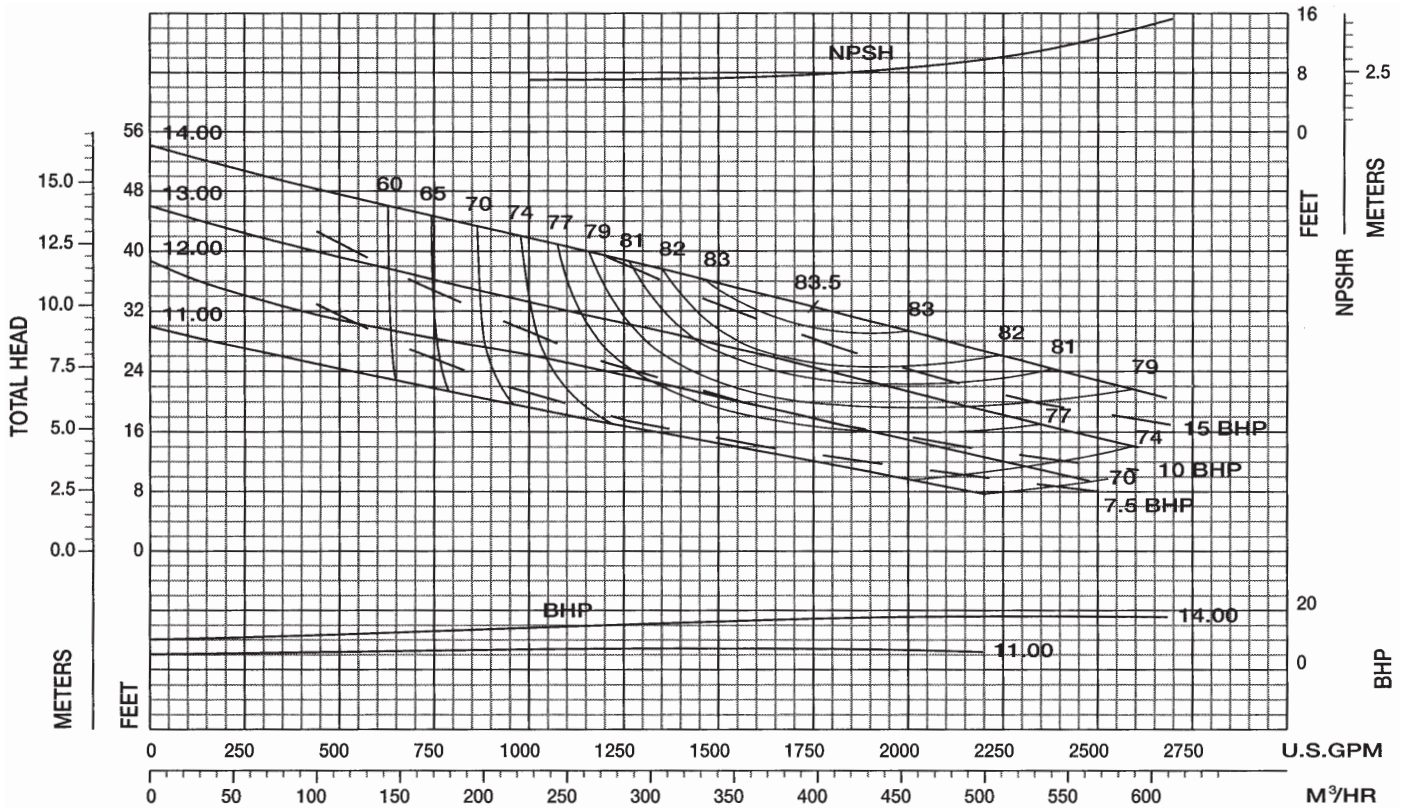

Performance Curve – 8" 5434L MV

RPM: **880** SOLIDS: **5"**

IMPELLER: **TAKC5W, 2 VANE** SUCTION: **10"** INLET: **99.93 in²**

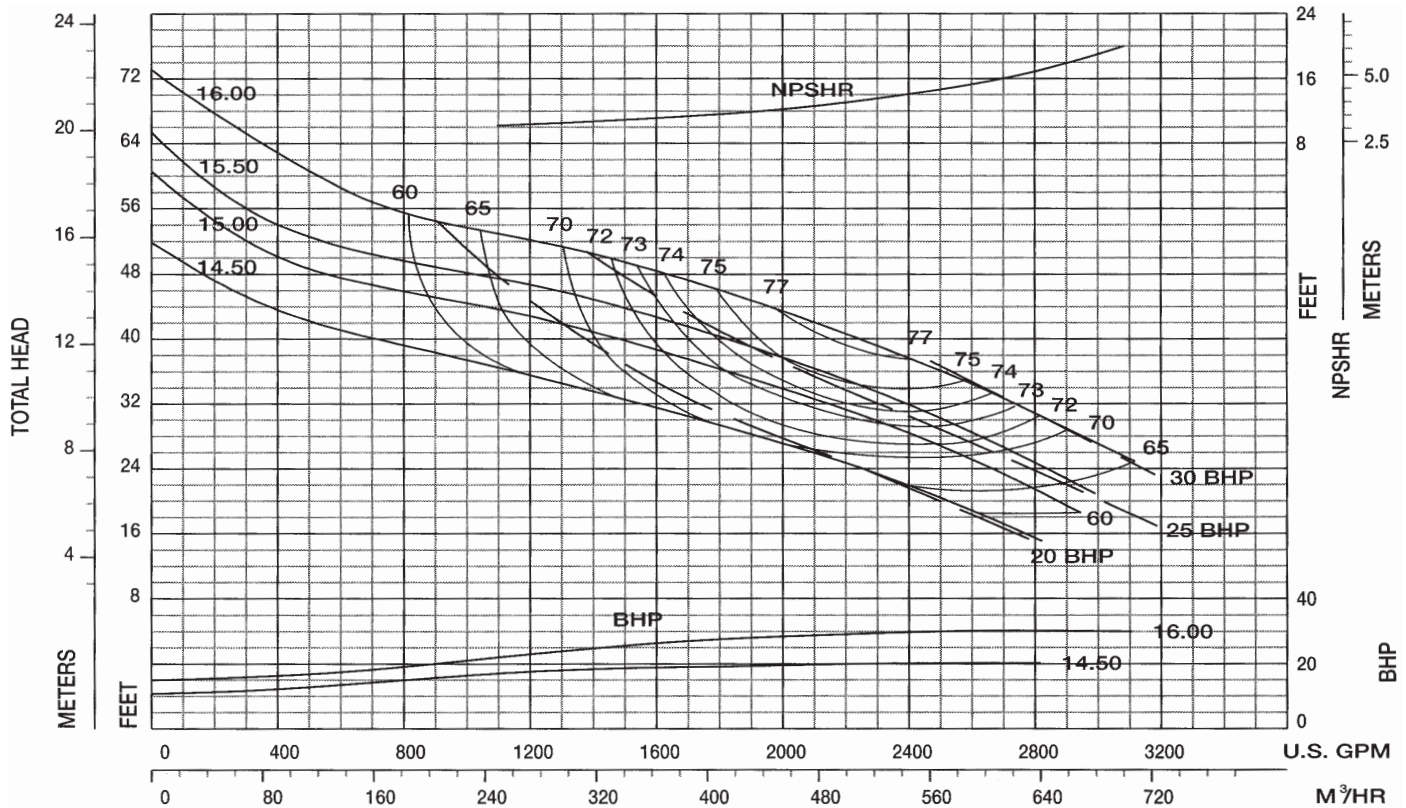

Performance Curve – 8" 5434L MV

RPM: **880** SOLIDS: **4"**

IMPELLER: **T8D1D, 2 VANE** SUCTION: **10"** INLET: **72.94 in²**

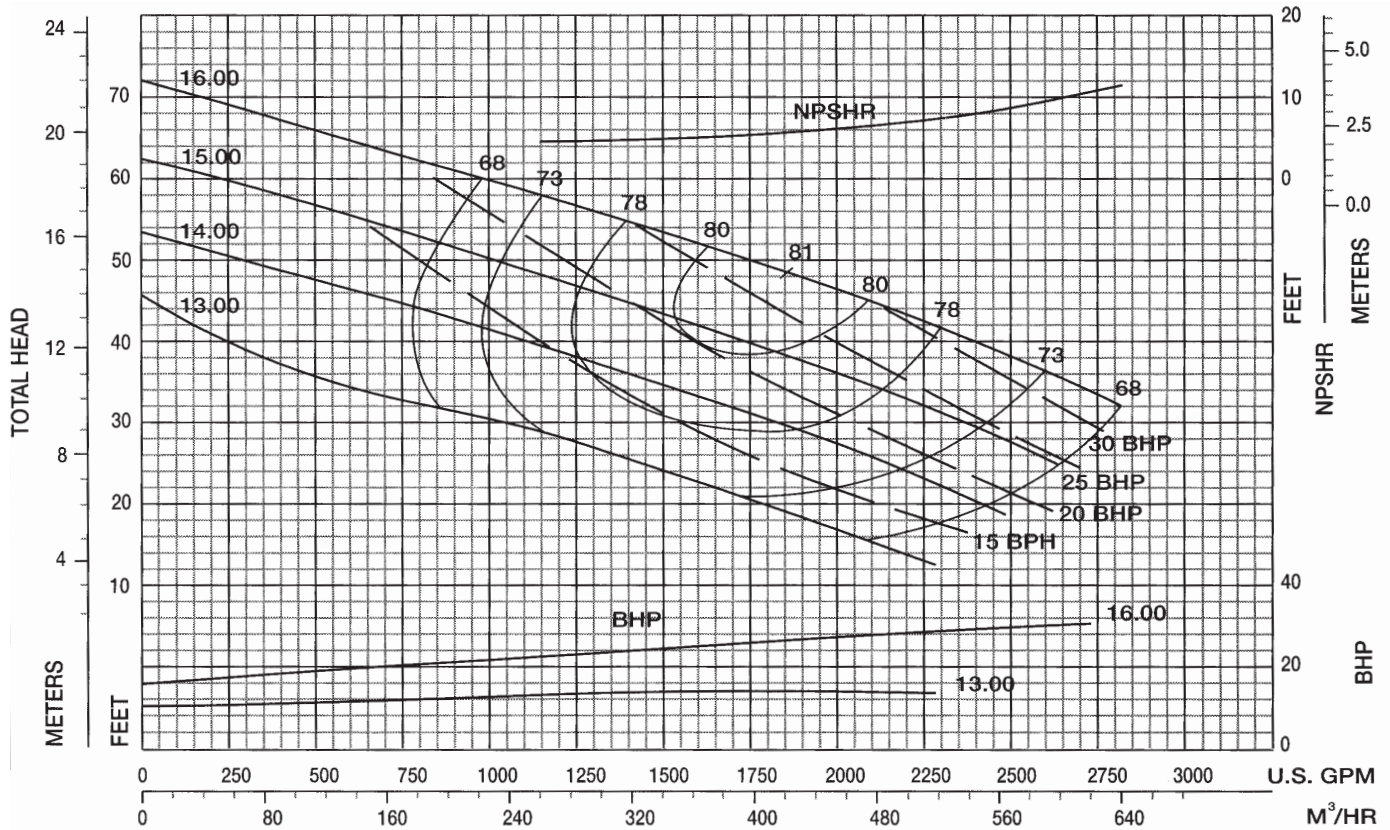

Performance Curve – 4" 5435 MT, W, WD

RPM: **865** SOLIDS: **3"**

IMPELLER: **T4E1E, 2 VANE** SUCTION: **4" (WD: 4" or 6")** INLET: **35.65 in²**

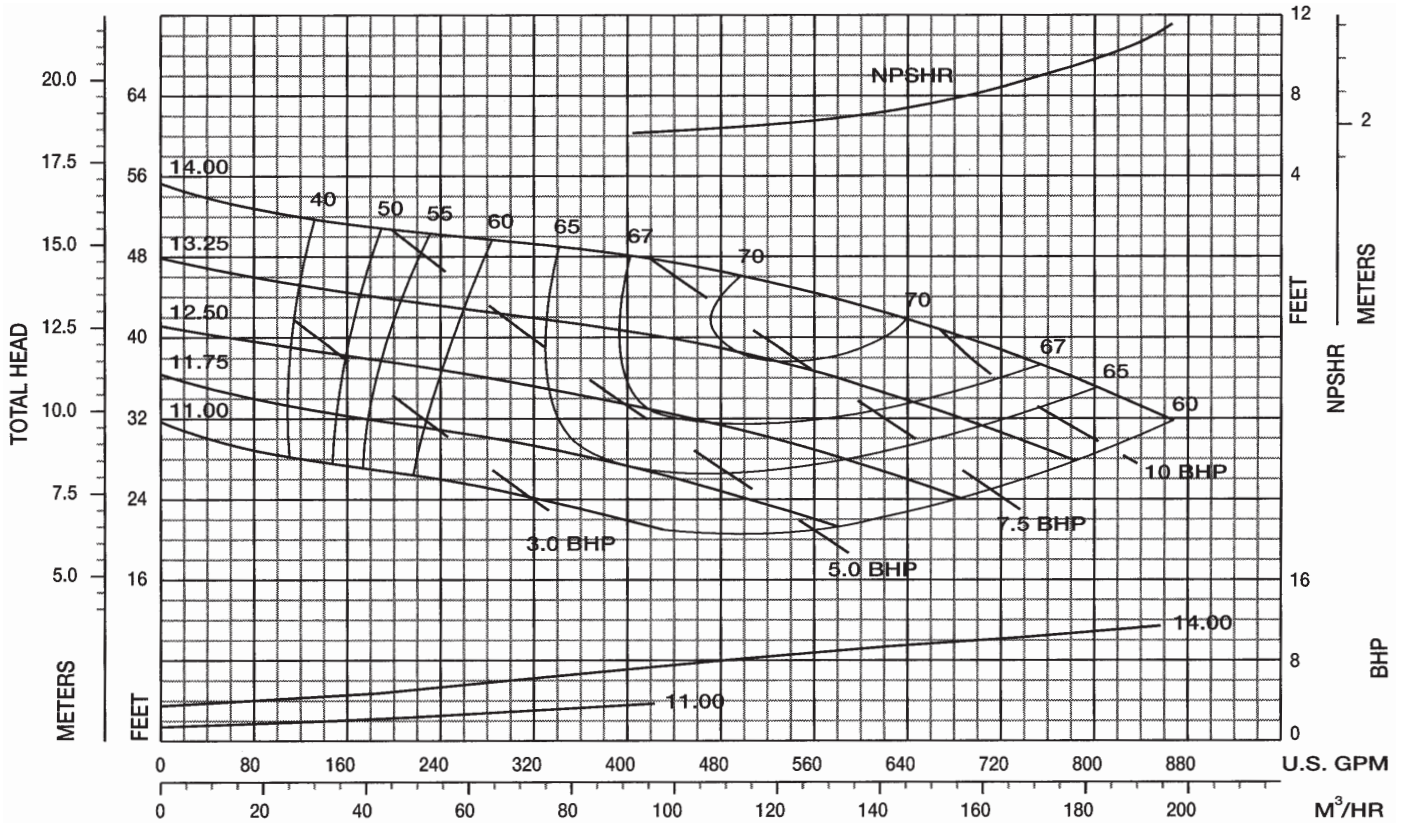

Performance Curve – 4" 5435 MV

RPM: **870** SOLIDS: **3"**

IMPELLER: **T4E1E, 2 VANE** SUCTION: **4"** INLET: **35.65 in²**

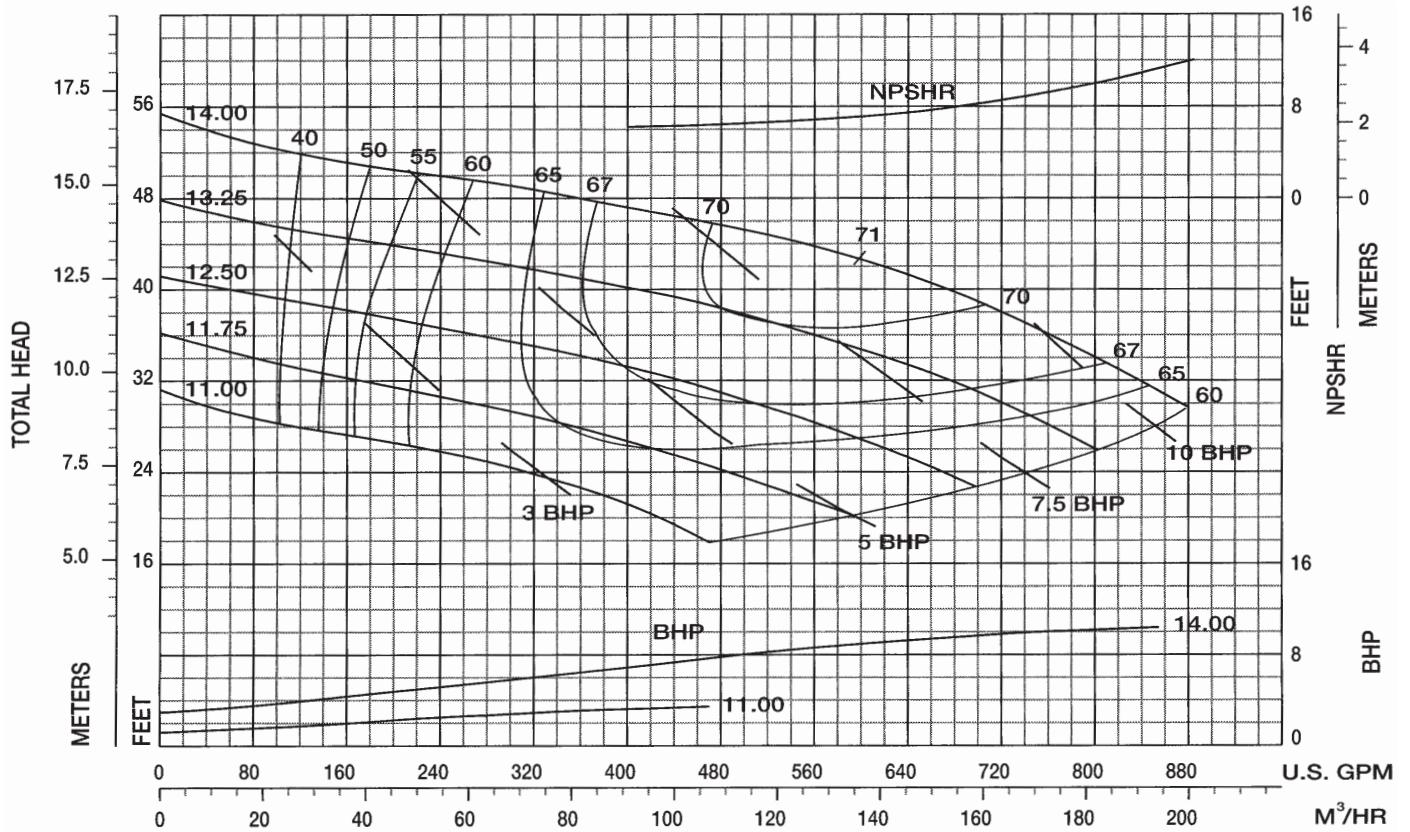

Performance Curve – 8" 5435 MT, W, WD

RPM: **880** SOLIDS: **5"**

IMPELLER: **TAKE5N, 2 VANE** SUCTION: **8" (WD: 8" or 10")** INLET: **130.29 in²**

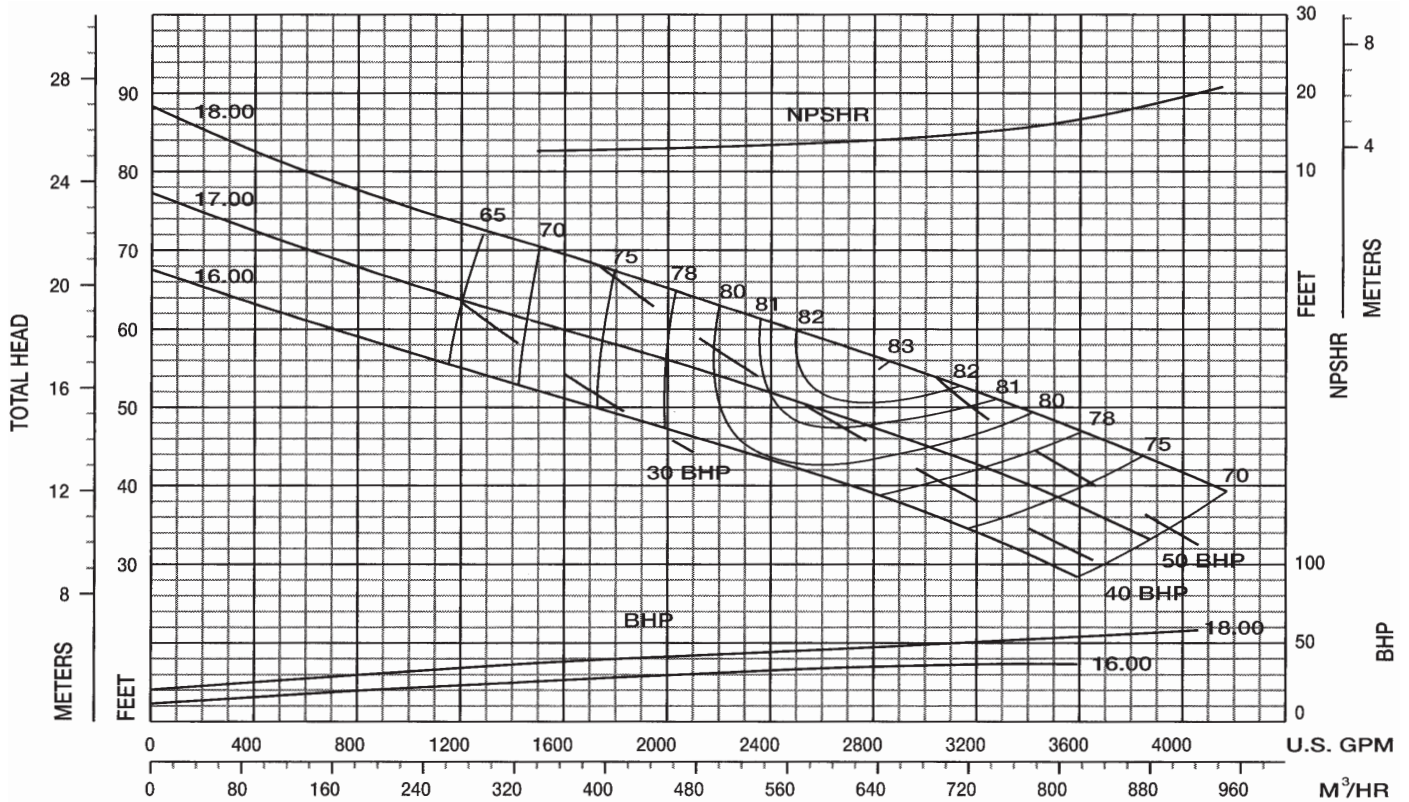

Performance Curve – 8" 5435 MV

RPM: **885** SOLIDS: **5"**

IMPELLER: **TAKE5N, 2 VANE** SUCTION: **8"** INLET: **130.29 in²**

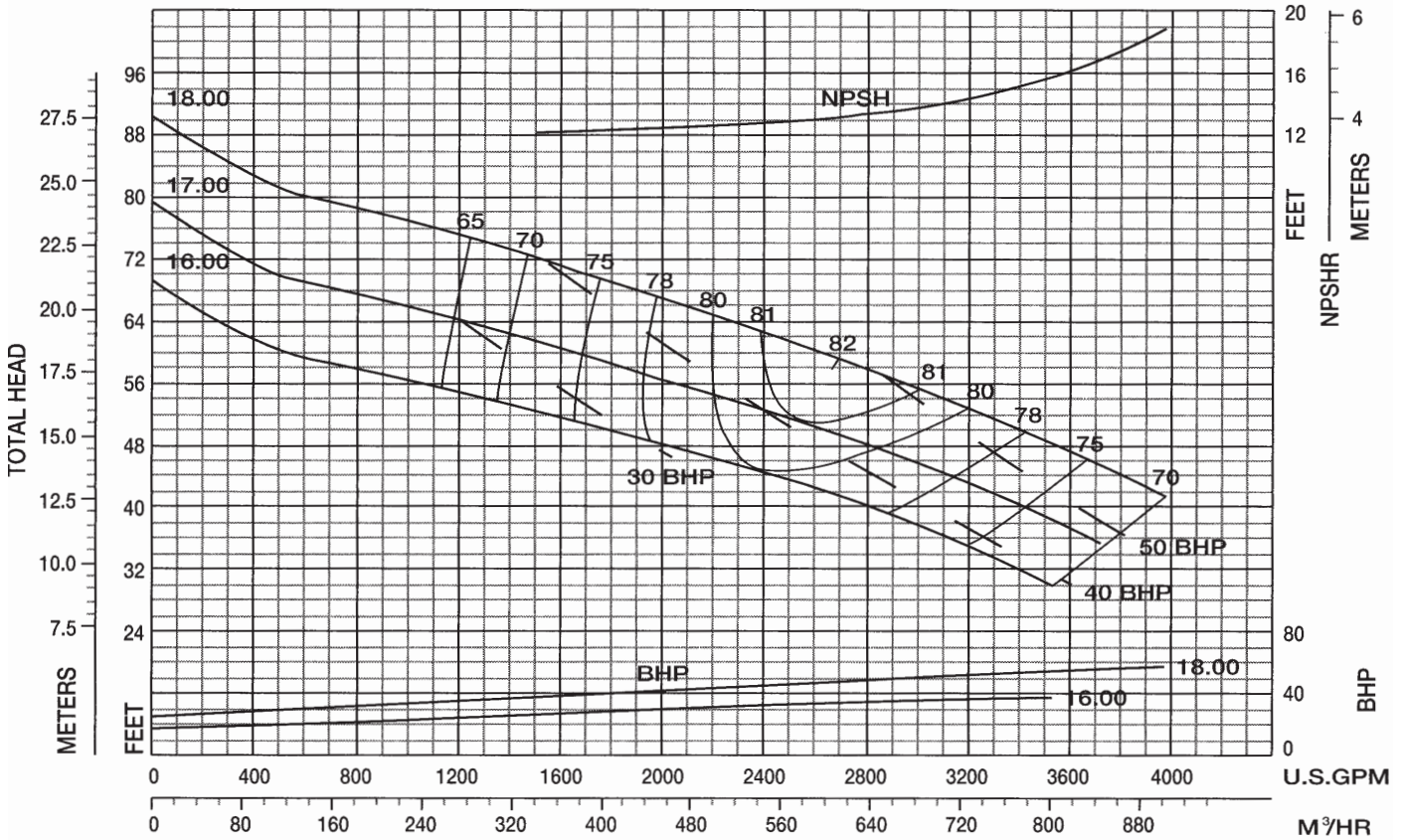

Performance Curve – 8" 5435 MT, W, WD

RPM: **880** SOLIDS: **5"**

IMPELLER: **TAKE5U, 2 VANE** SUCTION: **8" (WD: 8" or 10")** INLET: **108.36 in²**

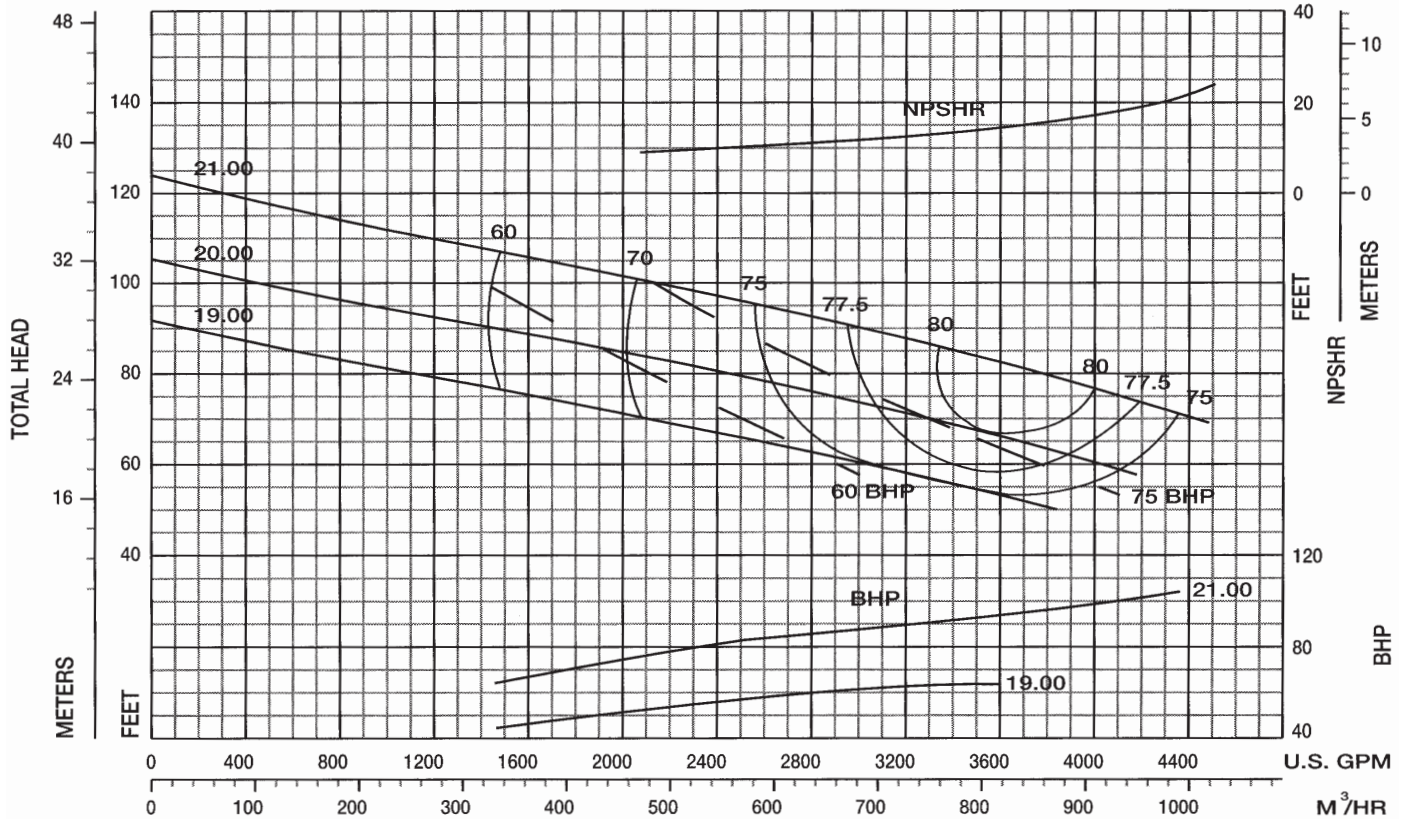

Performance Curve – 8" 5435 MV

RPM: **880** SOLIDS: **5"**

IMPELLER: **TAKE5U, 2 VANE** SUCTION: **8"** INLET: **108.36 in²**

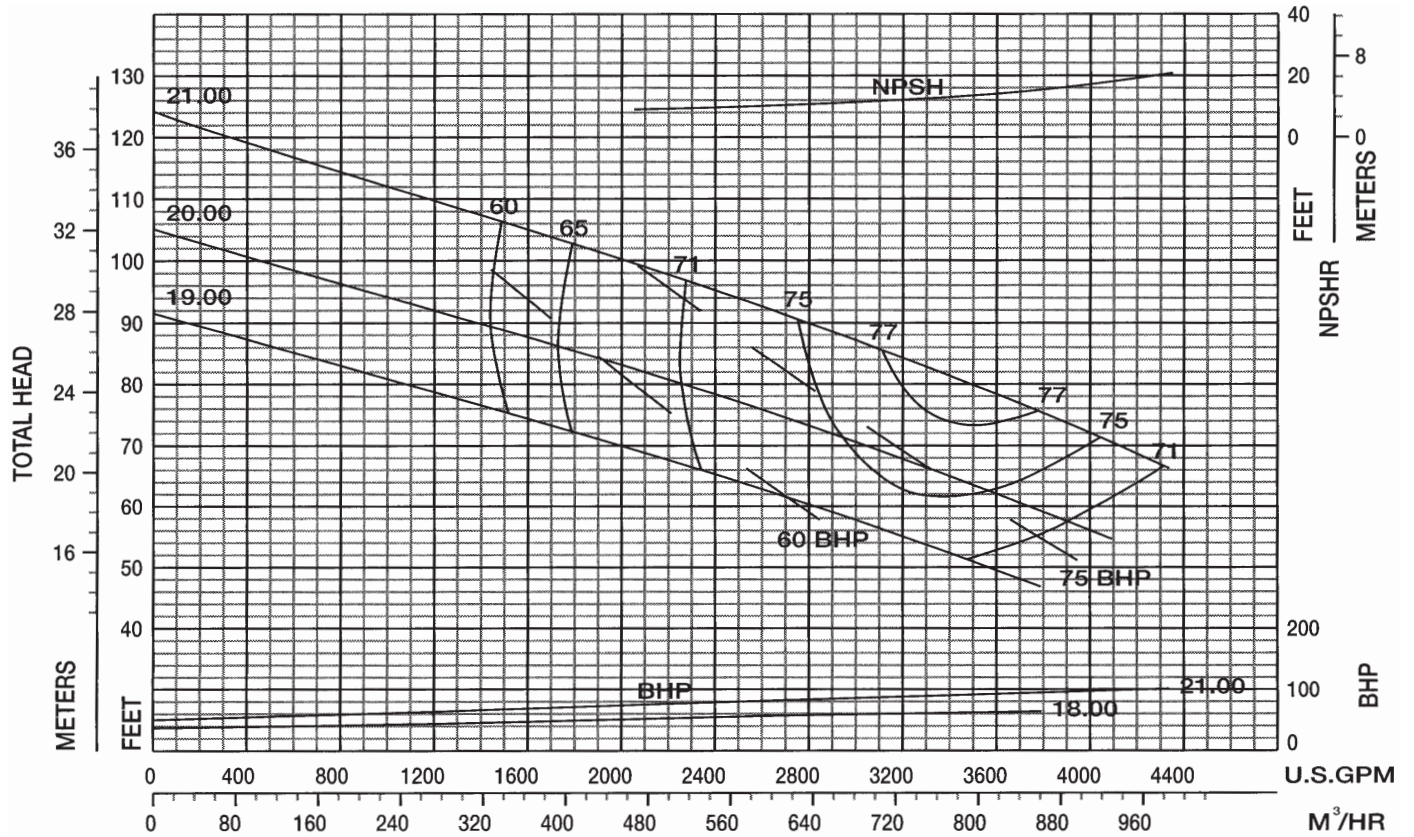

Performance Curve – 10" 5435 MTK, WK, WDK

RPM: **880** SOLIDS: **6"**

IMPELLER: **TALE5AL, BLADELESS** SUCTION: **10"** INLET: **63.62 in²**

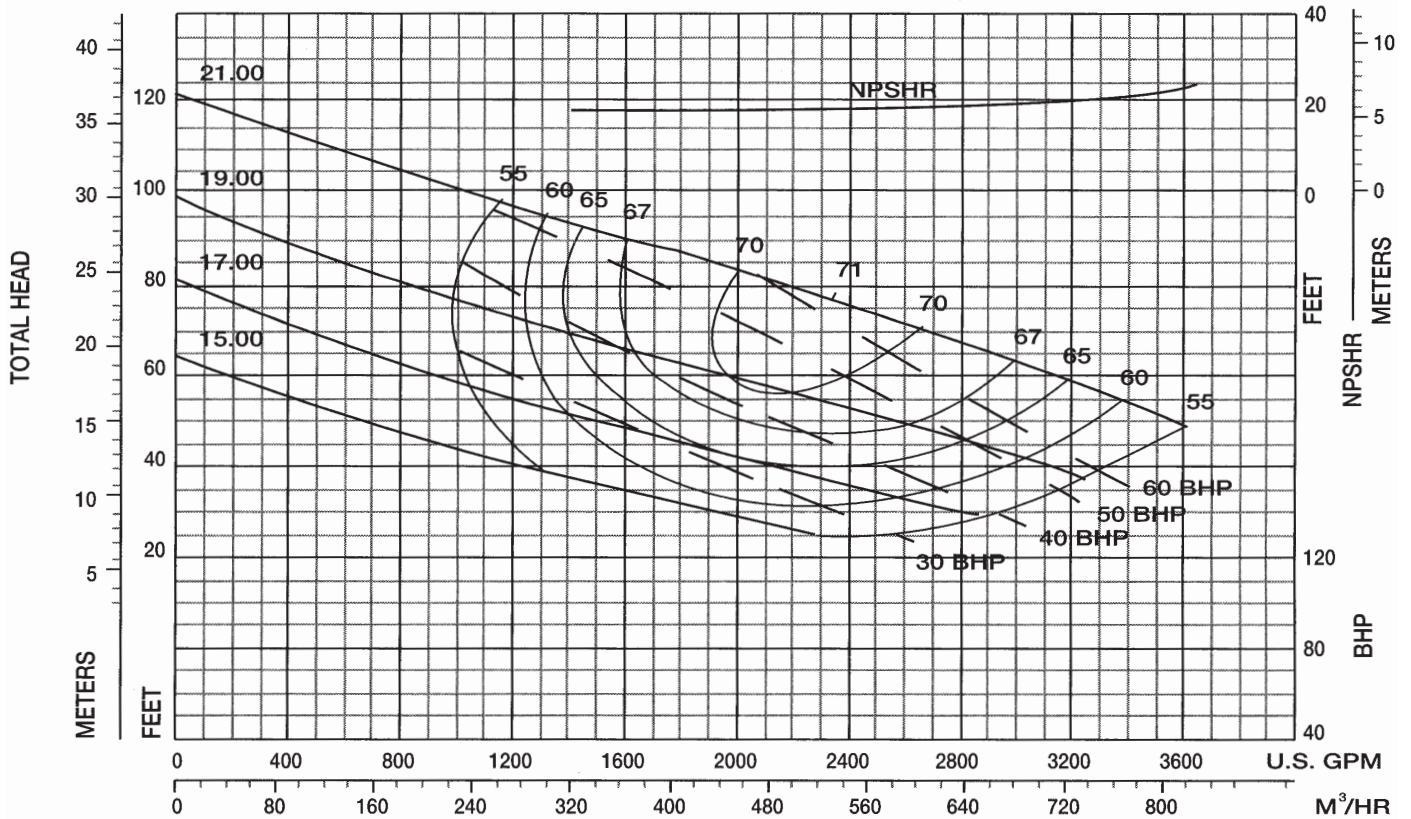

Performance Curve – 10" 5435 MT, W, WD

RPM: **880** SOLIDS: **6"**

IMPELLER: **TALE5A, 2 VANE** SUCTION: **10" (WD: 10" or 12")** INLET: **127.43 in²**

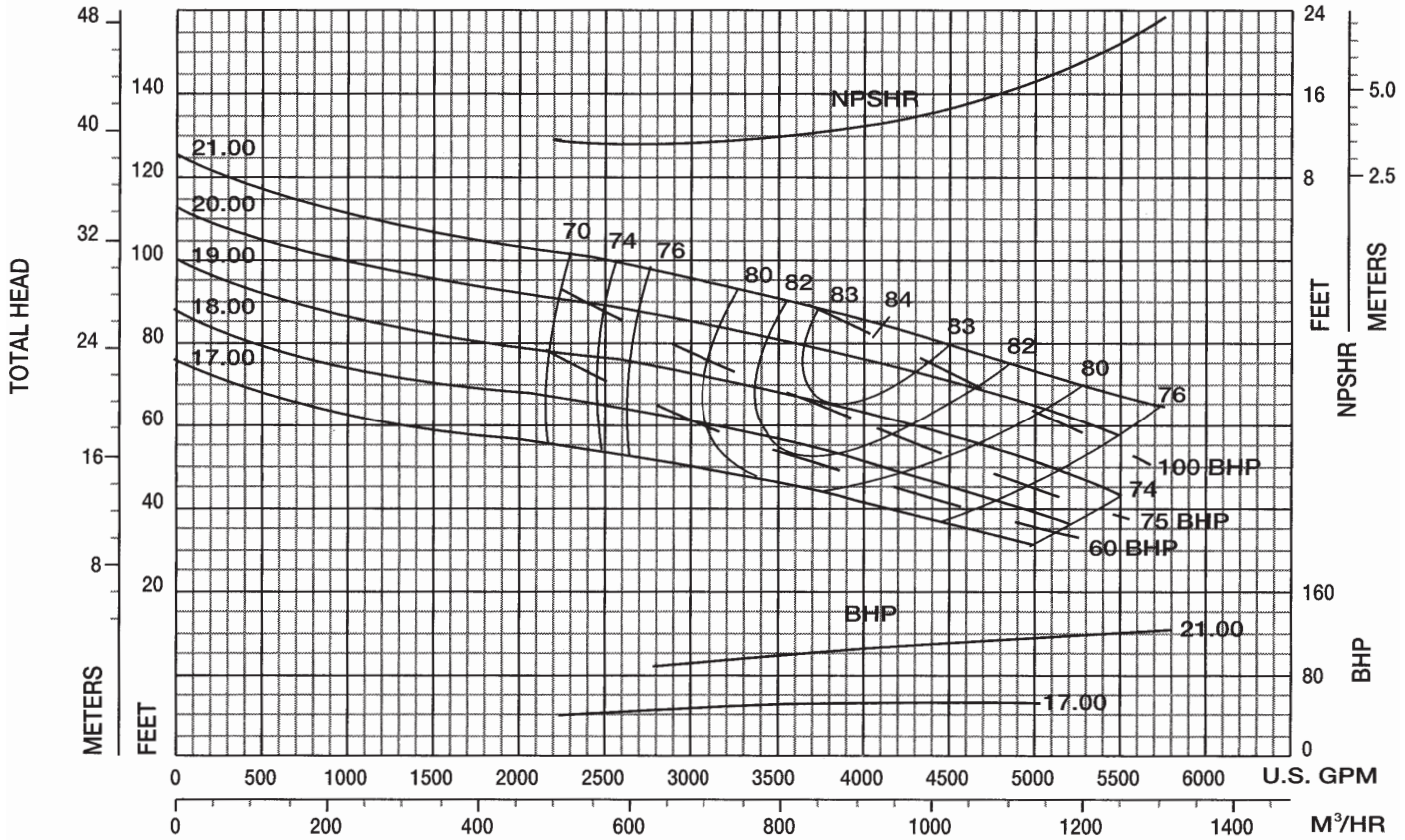

Performance Curve – 10" 5435 MVK

RPM: **880** SOLIDS: **6"**

IMPELLER: **TALE5AL, BLADELESS** SUCTION: **10"** INLET: **63.62 in²**

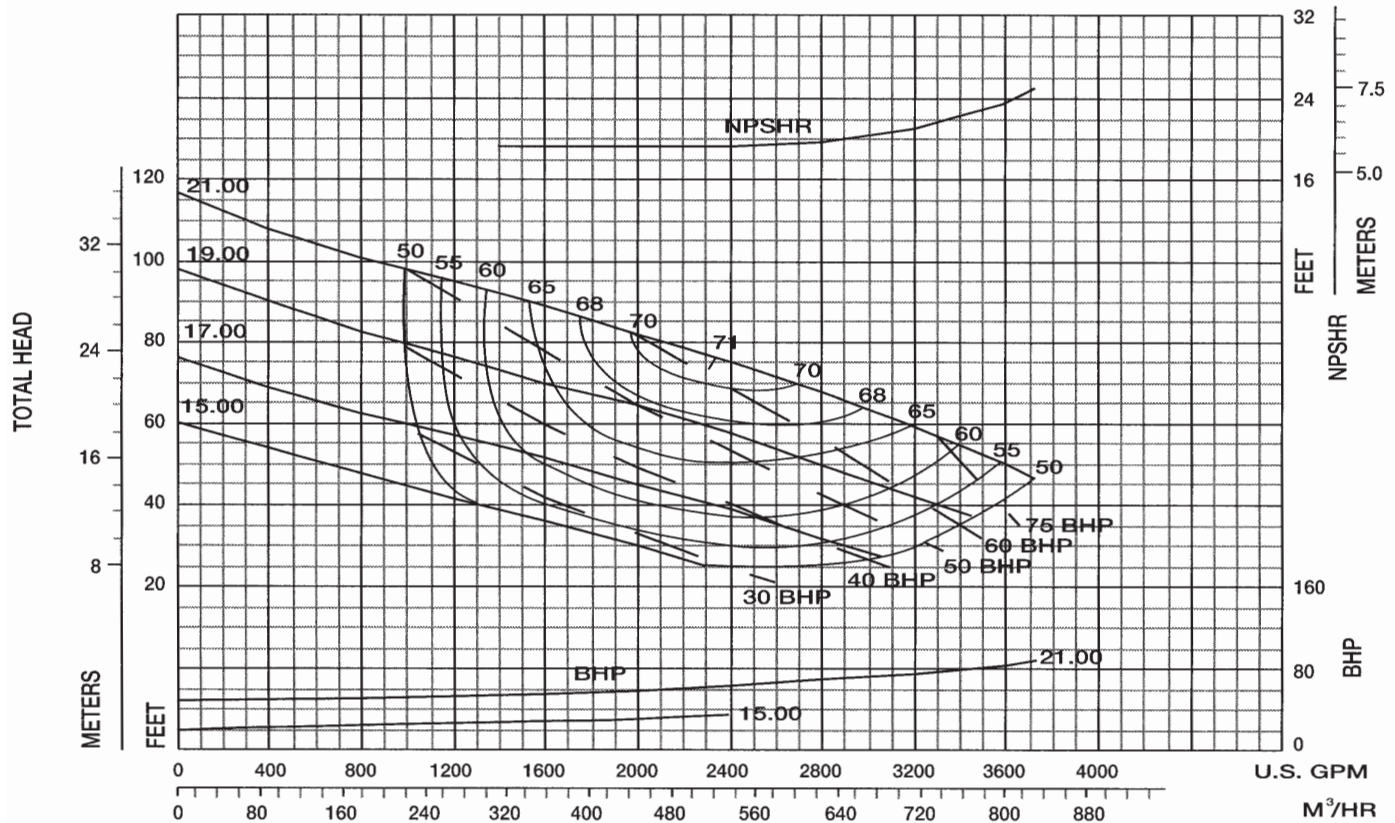

Performance Curve – 10" 5435 MV

RPM: 880 SOLIDS: 6"

IMPELLER: TALE5A, 2 VANE SUCTION: 10" INLET: 127.43 in²

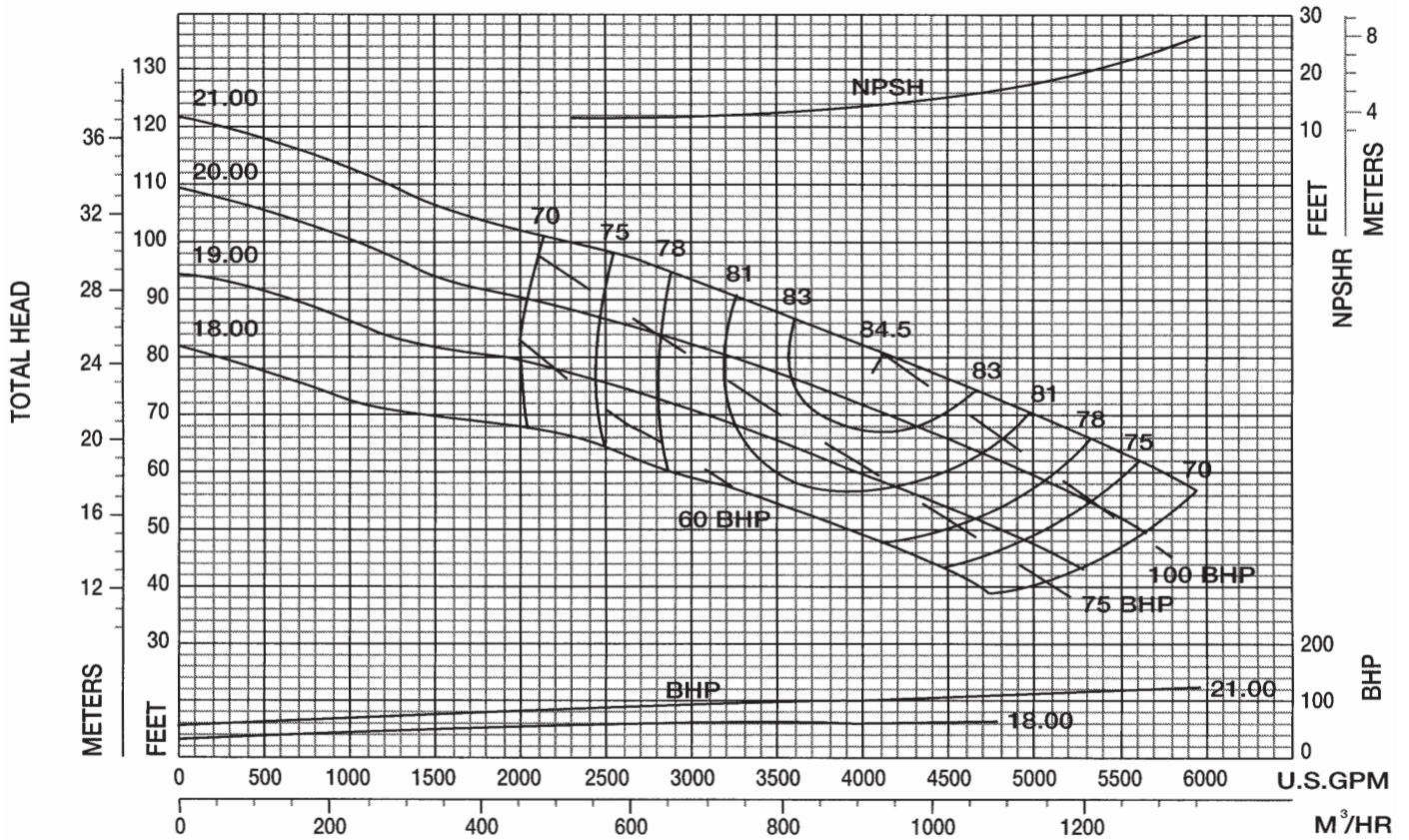

Performance Curve – 5" 5436 MT, W, WD

RPM: 855 SOLIDS: 3"

IMPELLER: T5D1AS, 2 VANE SUCTION: 8" (WD: 8" or 10") INLET: 52.05 in²

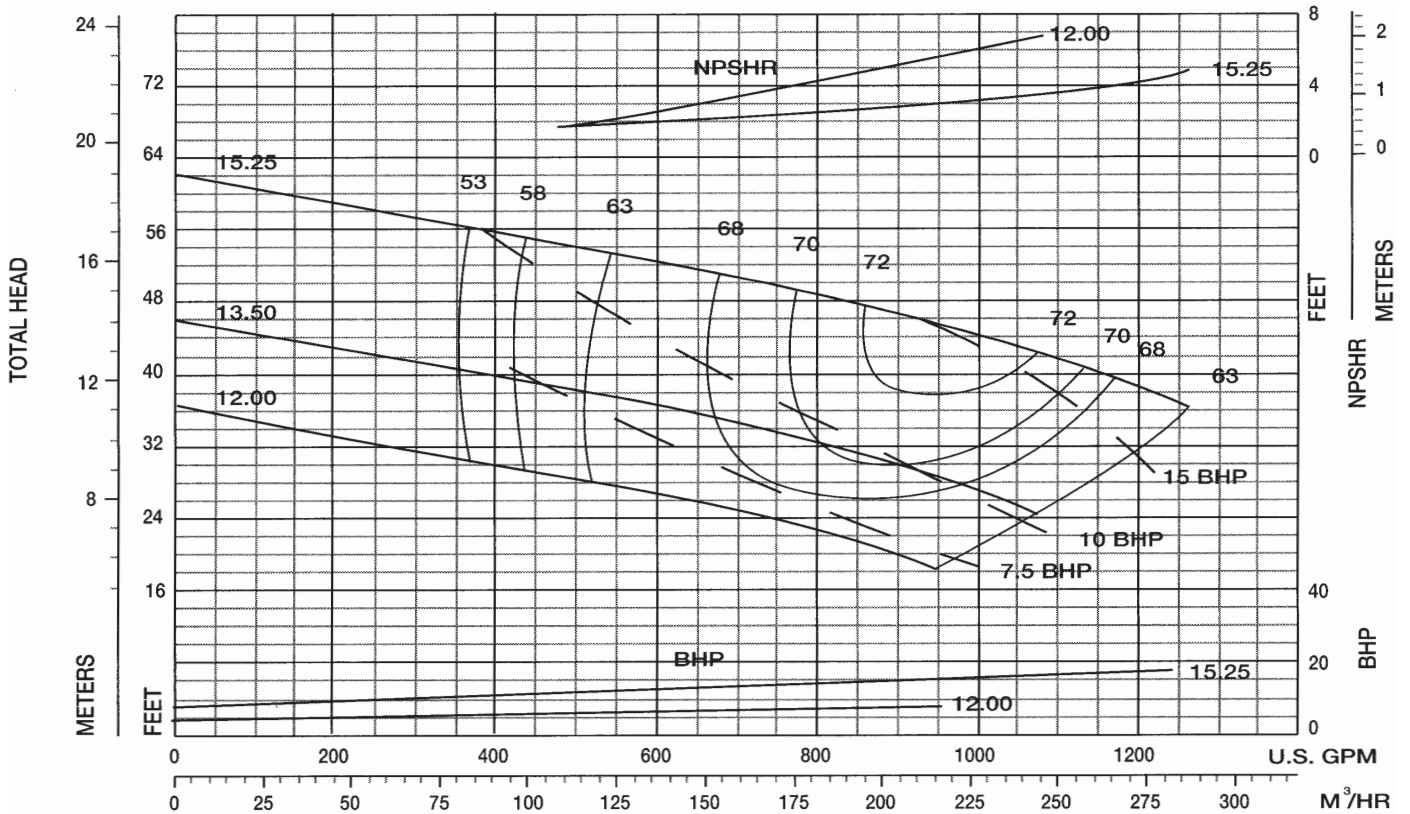

Performance Curve – 5" 5436 MV

RPM: **855** SOLIDS: **3"**

IMPELLER: **T5D1A5, 2 VANE** SUCTION: **8"** INLET: **52.05 in²**

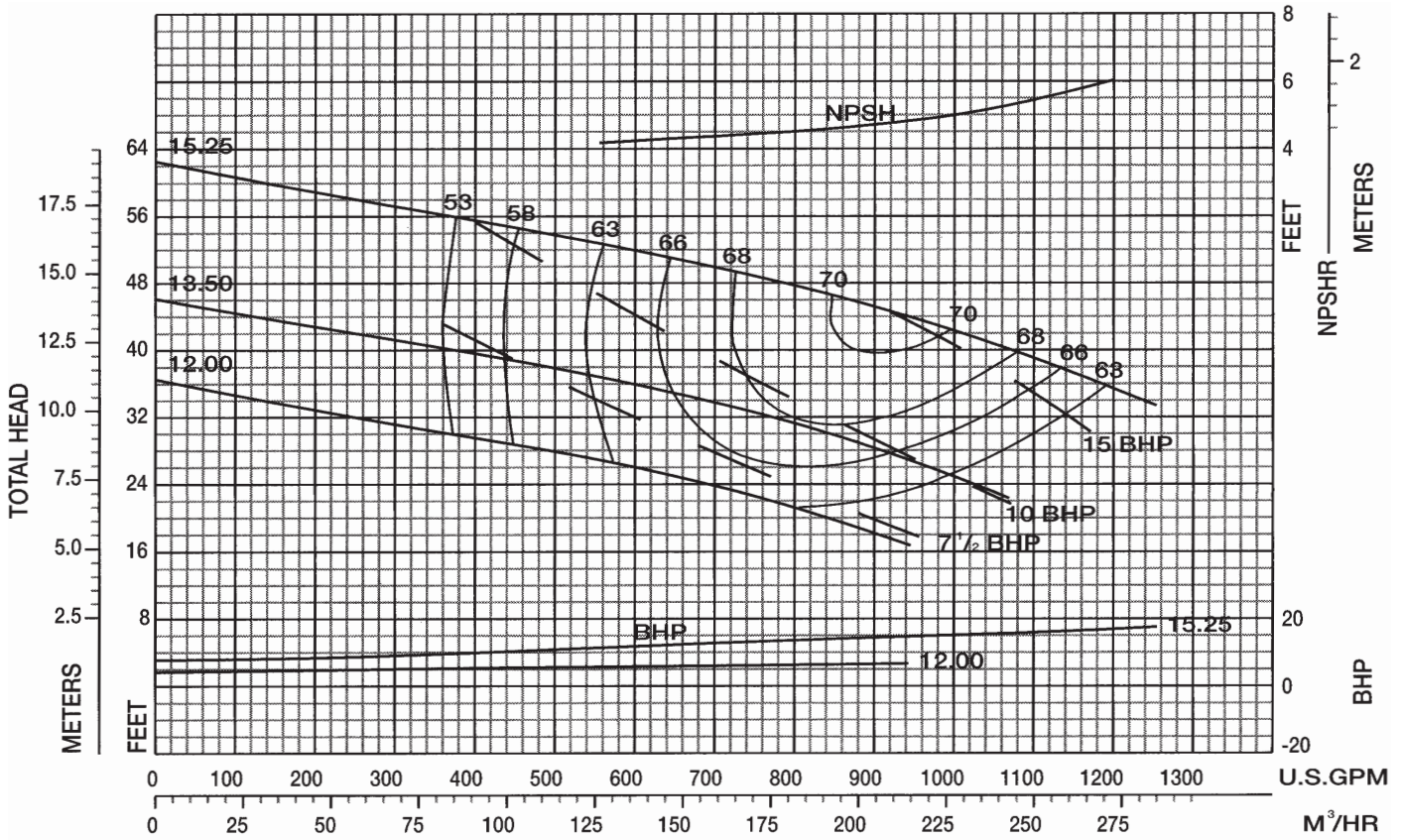

Performance Curve – 6" 5436 MT, W, WD

RPM: **880** SOLIDS: **3"**

IMPELLER: **T6E1G, 2 VANE** SUCTION: **10" (WD: 10")** INLET: **59.32 in²**

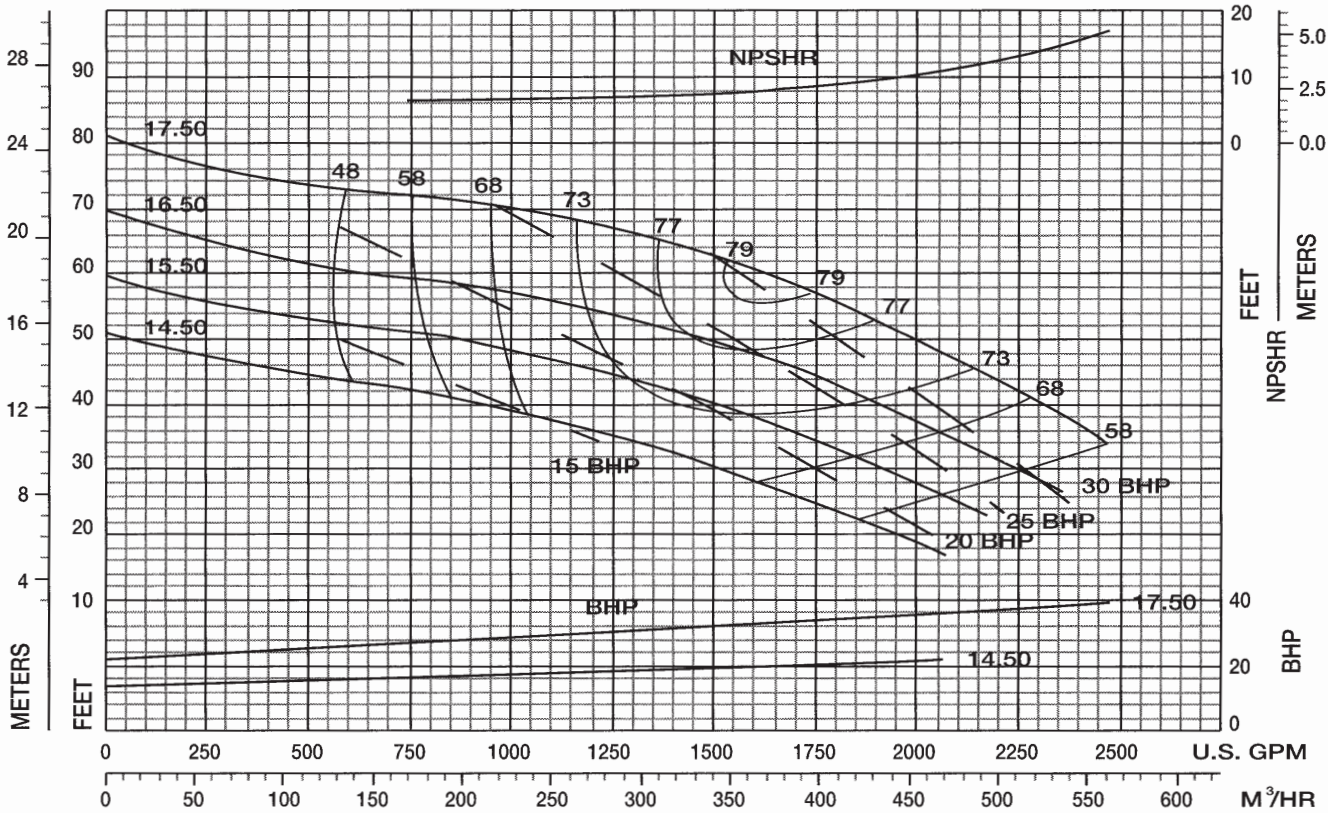

Performance Curve – 6" 5436L W, WD

RPM: 880 SOLIDS: 3"

IMPELLER: T6F1C, 3 VANE SUCTION: 10" INLET: 93.30 in²

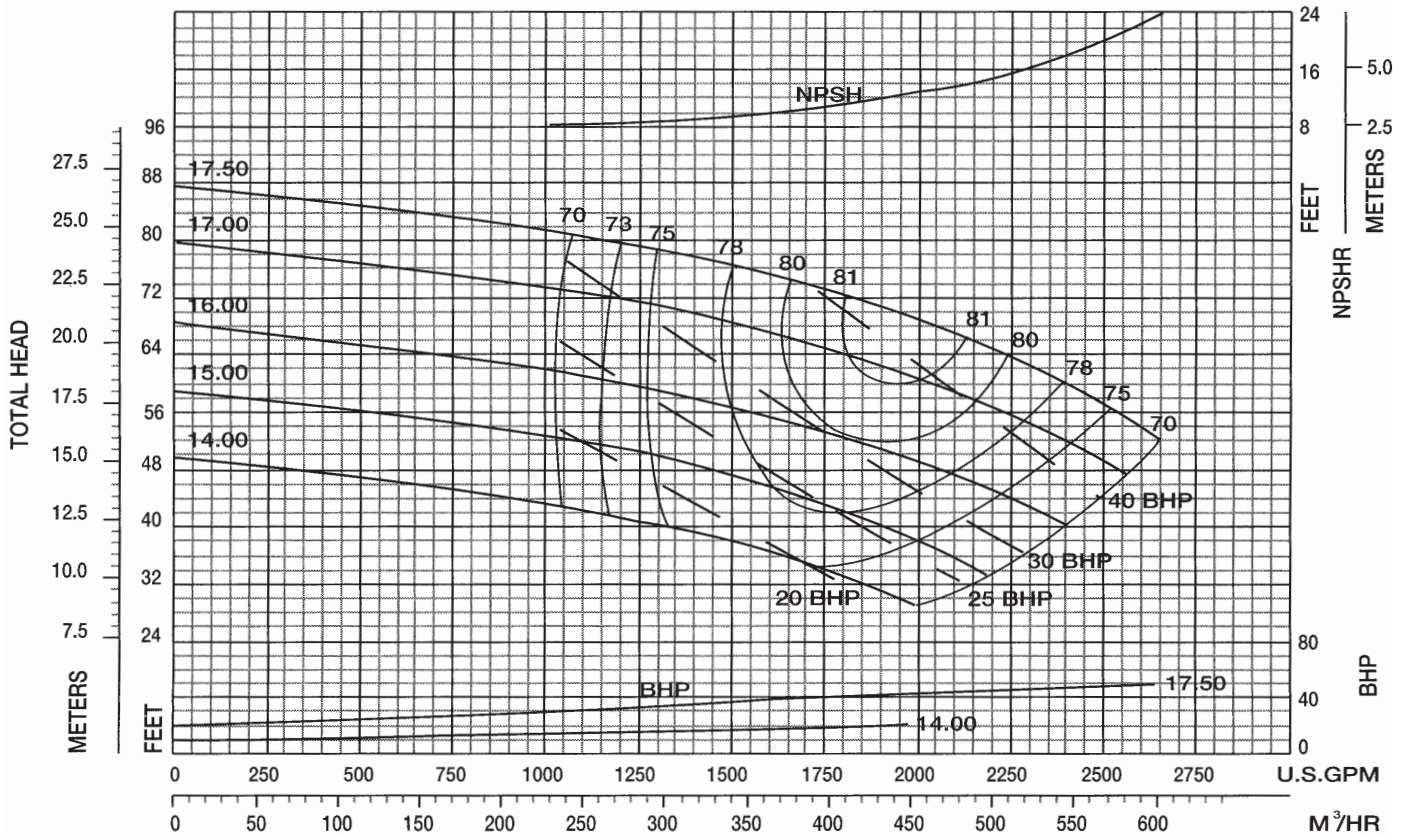

Performance Curve – 8" 5436 MT, W, WD

RPM: 880 SOLIDS: 5"

IMPELLER: TAKE5DF, 2 VANE SUCTION: 10" (WD: 12") INLET: 93.22 in²

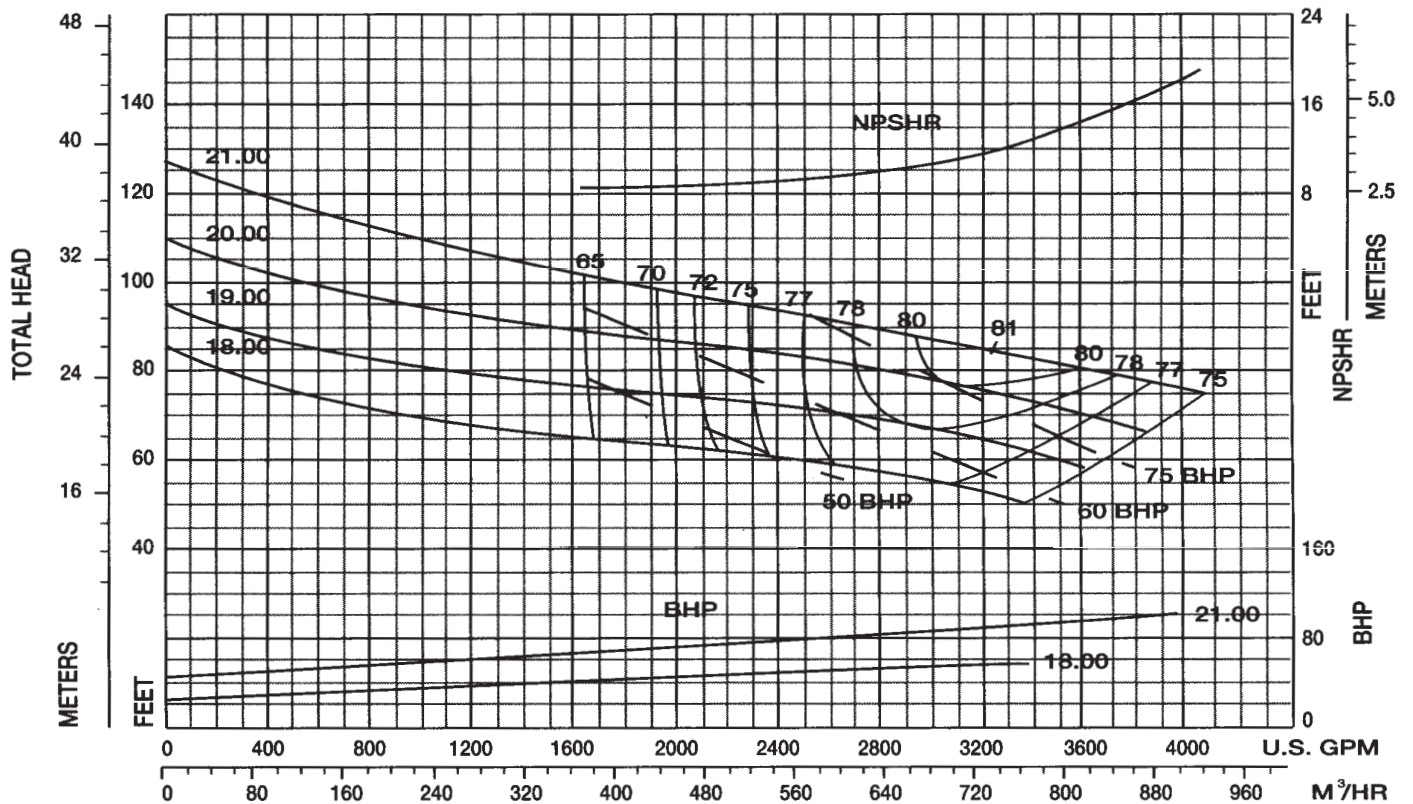

Performance Curve – 8" 5436 MV

RPM: **880** SOLIDS: **5"**

IMPELLER: TAKE5DF, 2 VANE SUCTION: 8" INLET: 93.22 in²

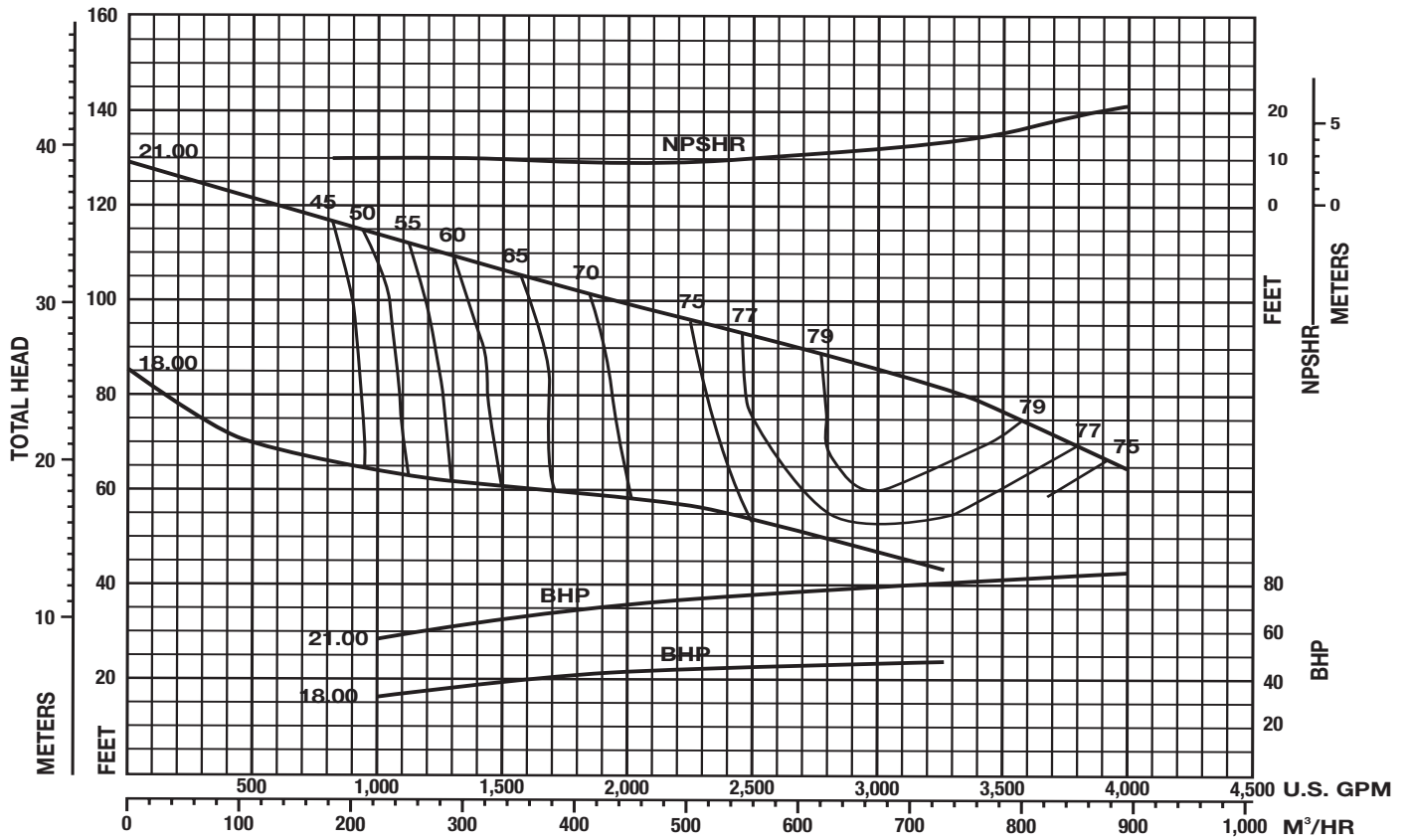

Performance Curve – 4" 5434 MT, W, WD

RPM: **705** SOLIDS: **2-3/4"**

IMPELLER: T4D1B, 2 VANE SUCTION: 5" (WD: 5", 6" or 8") INLET: 47.01 in²

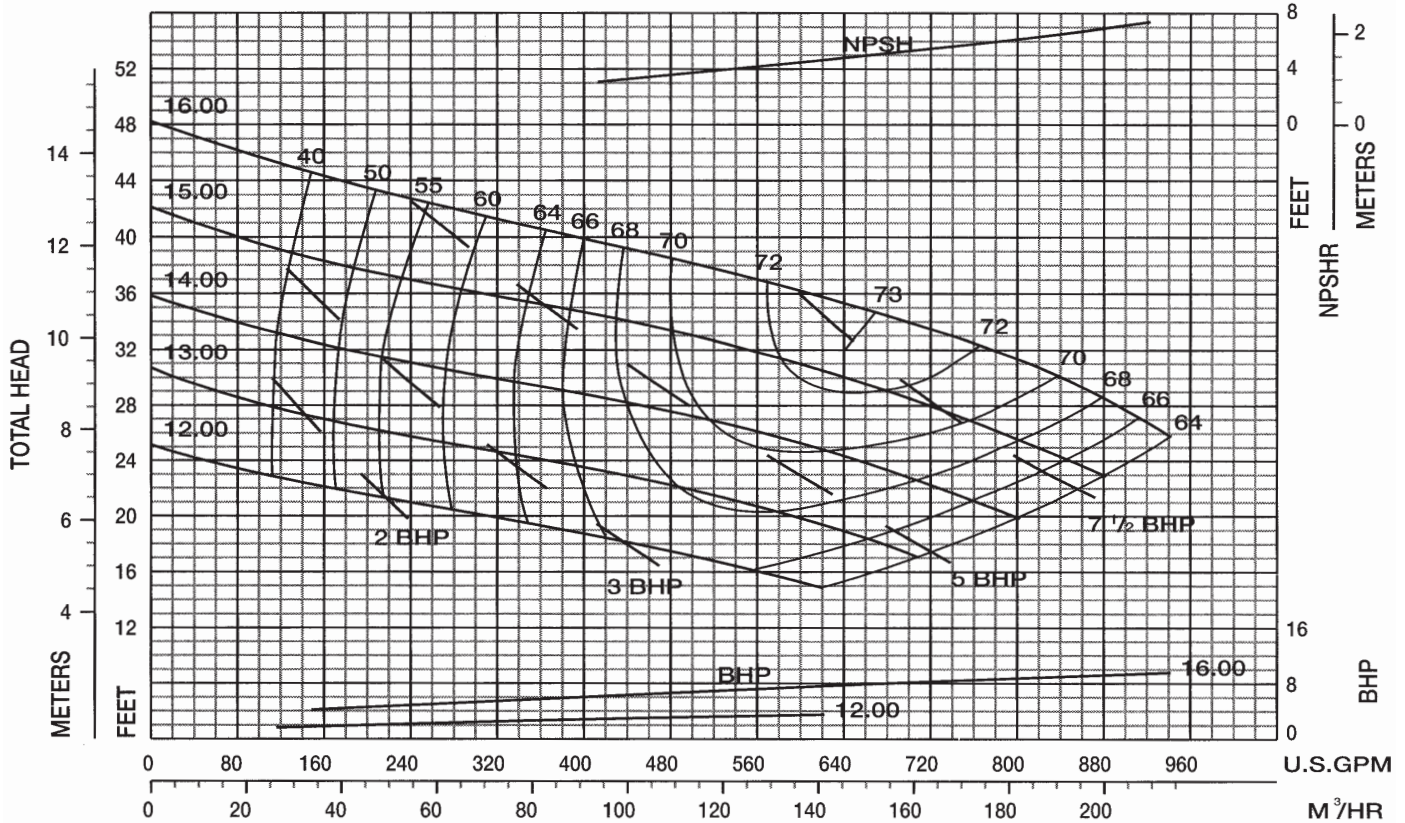

Performance Curve – 4" 5434 MV

RPM: 705 SOLIDS: 2-3/4"

IMPELLER: T4D1B, 2 VANE SUCTION: 5" INLET: 47.01 in²

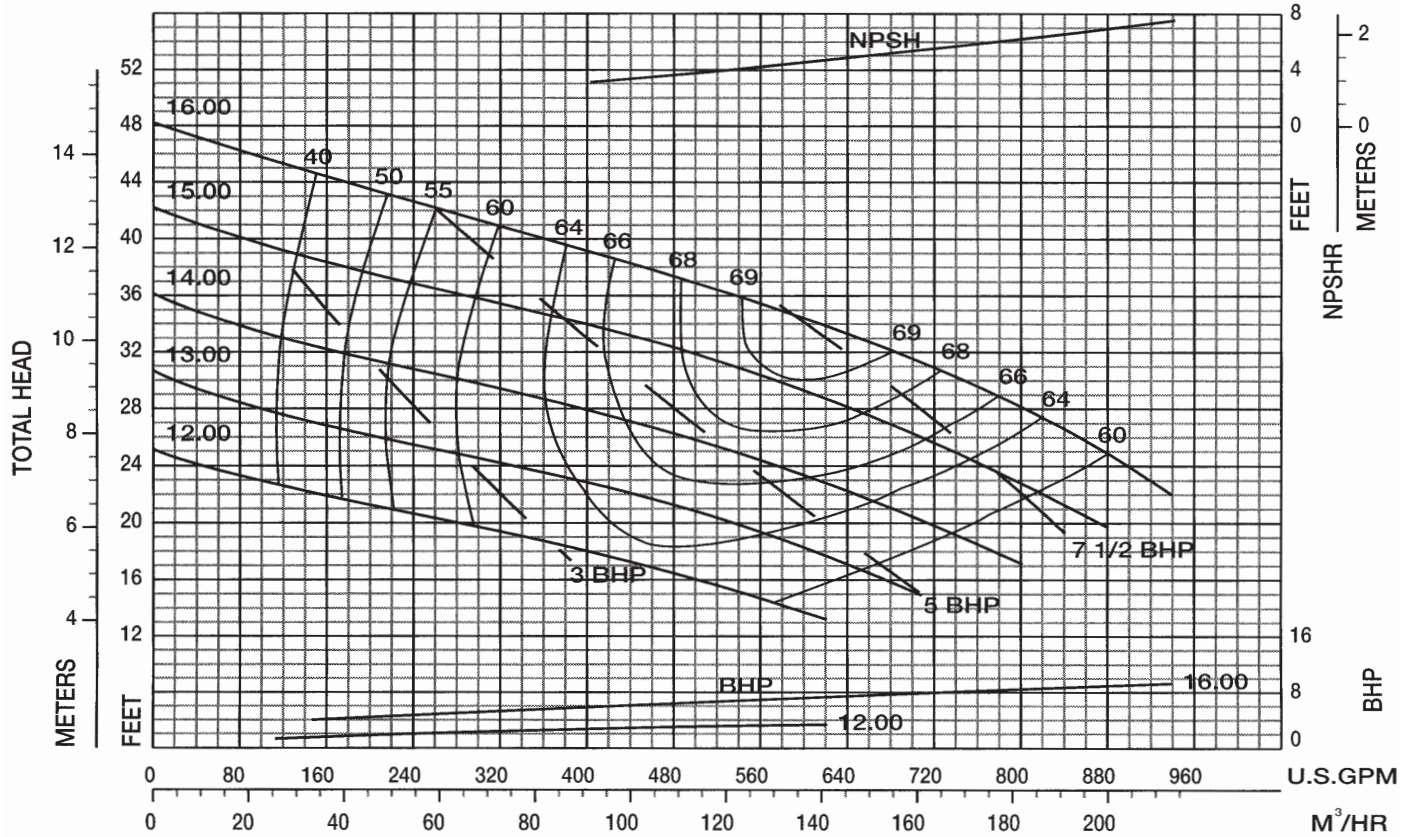

Performance Curve – 5" 5434 MT, W, WD

RPM: 705 SOLIDS: 4"

IMPELLER: T5D1A, 2 VANE SUCTION: 5" (WD: 5" or 8") INLET: 53.89 in²

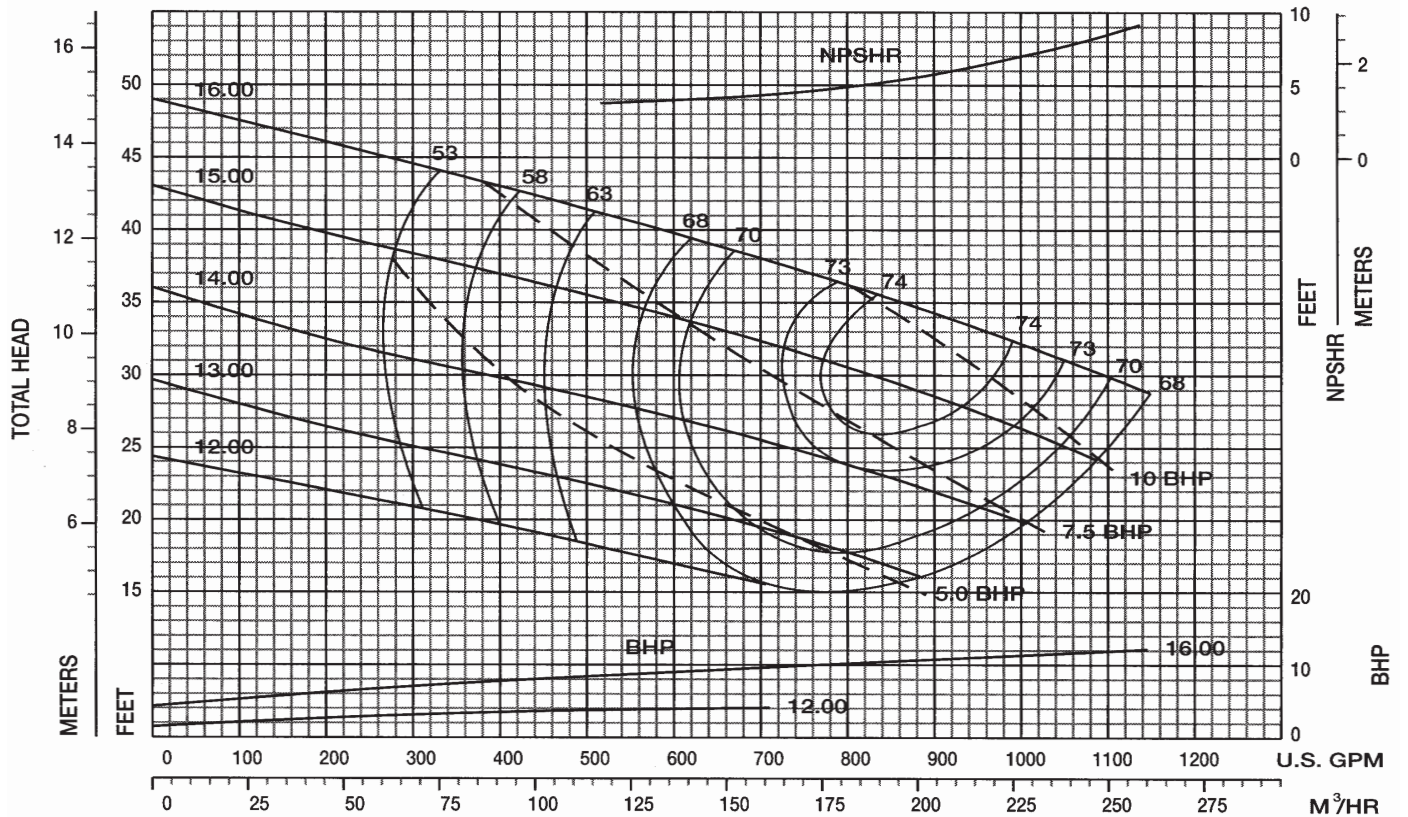

Performance Curve – 6" 5434 MTK, WK, WDK

RPM: **705** SOLIDS: **4"**

IMPELLER: **T6D1A, BLADELESS** SUCTION: **6" (WDK: 6" or 8")** INLET: **36.42 in²**

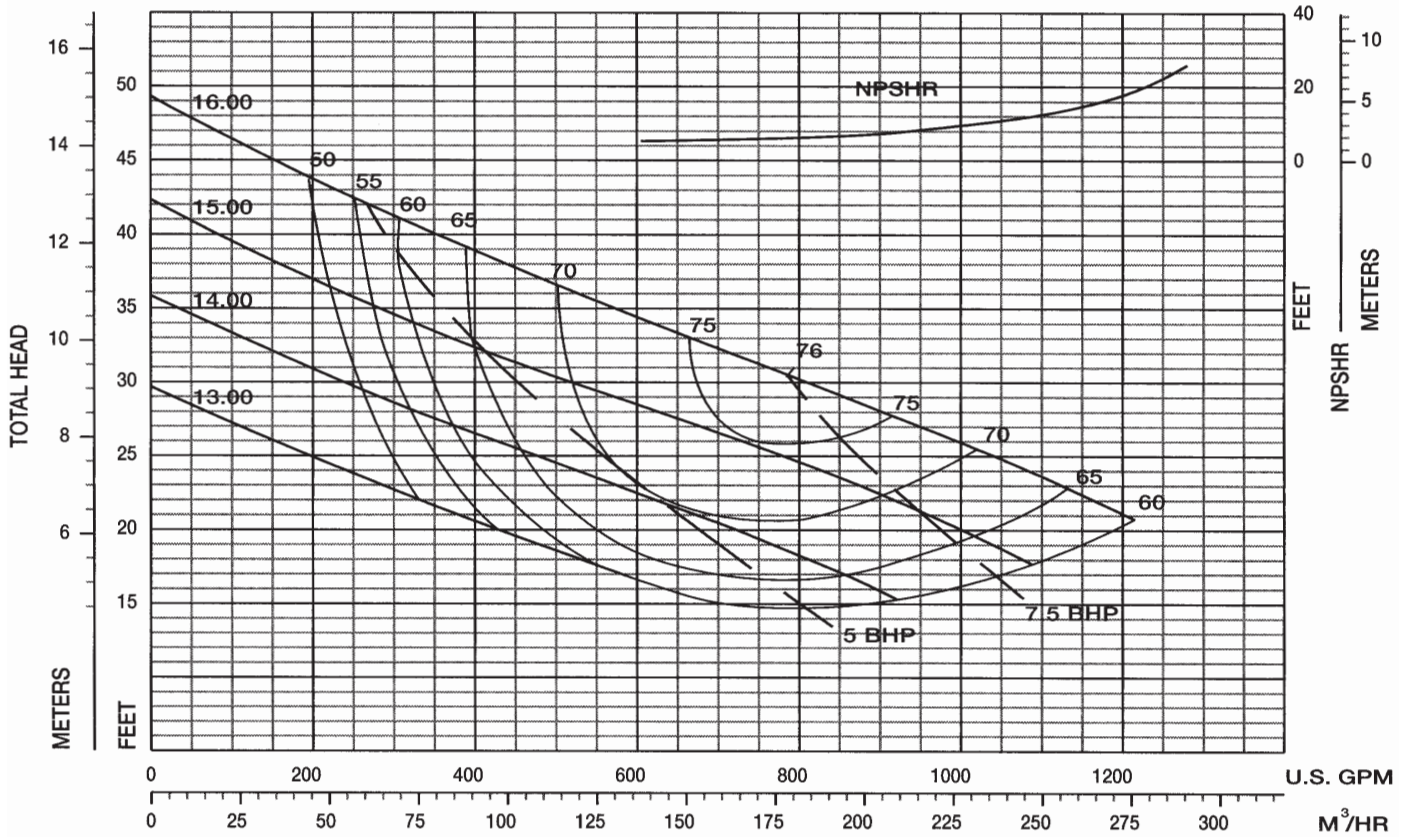

Performance Curve – 6" 5434 MT, W, WD

RPM: **705** SOLIDS: **3"**

IMPELLER: **TAJC5BH, 2 VANES** SUCTION: **6" (WD: 6" or 8")** INLET: **60.58 in²**

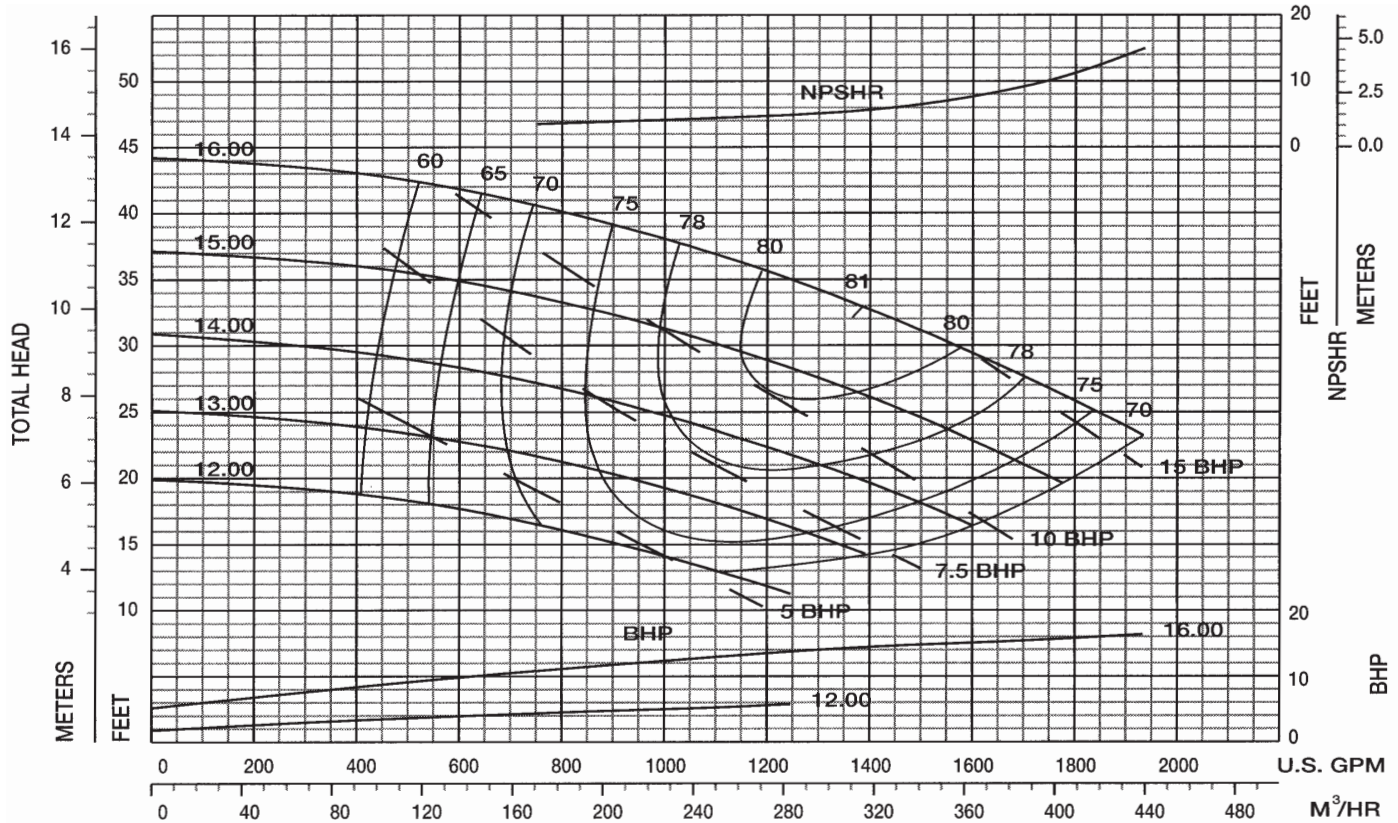

Performance Curve – 6" 5434 MT, W, WD

RPM: 705 SOLIDS: 4"

IMPELLER: TAJC5DC, 2 VANE SUCTION: 6" (WD: 6" or 8") INLET: 70.85 in²

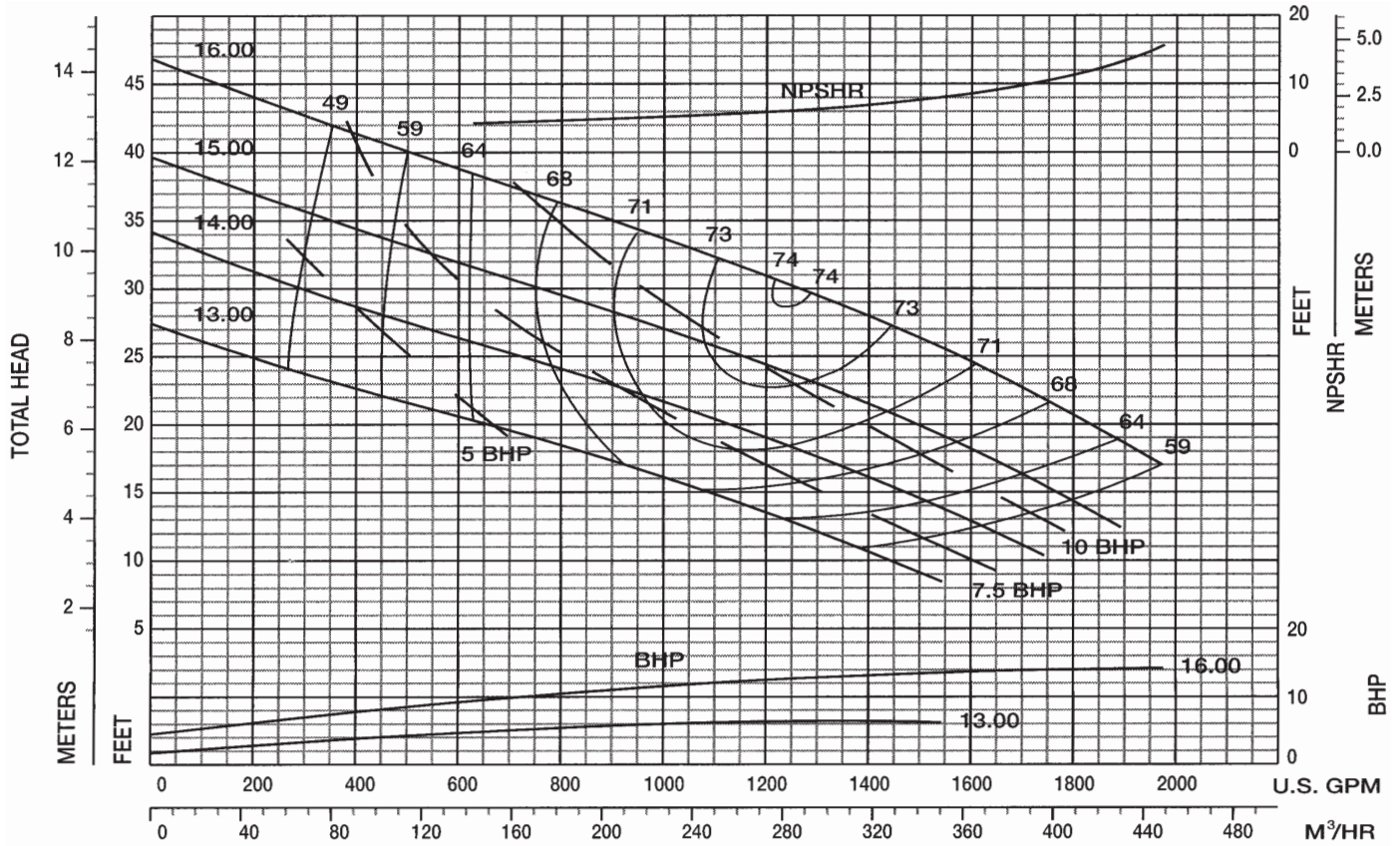

Performance Curve – 6" 5434 MT, W, WD

RPM: 705 SOLIDS: 3"

IMPELLER: TAJC5BJ, 3 VANE SUCTION: 6" (WD: 6" or 8") INLET: 64.55 in²

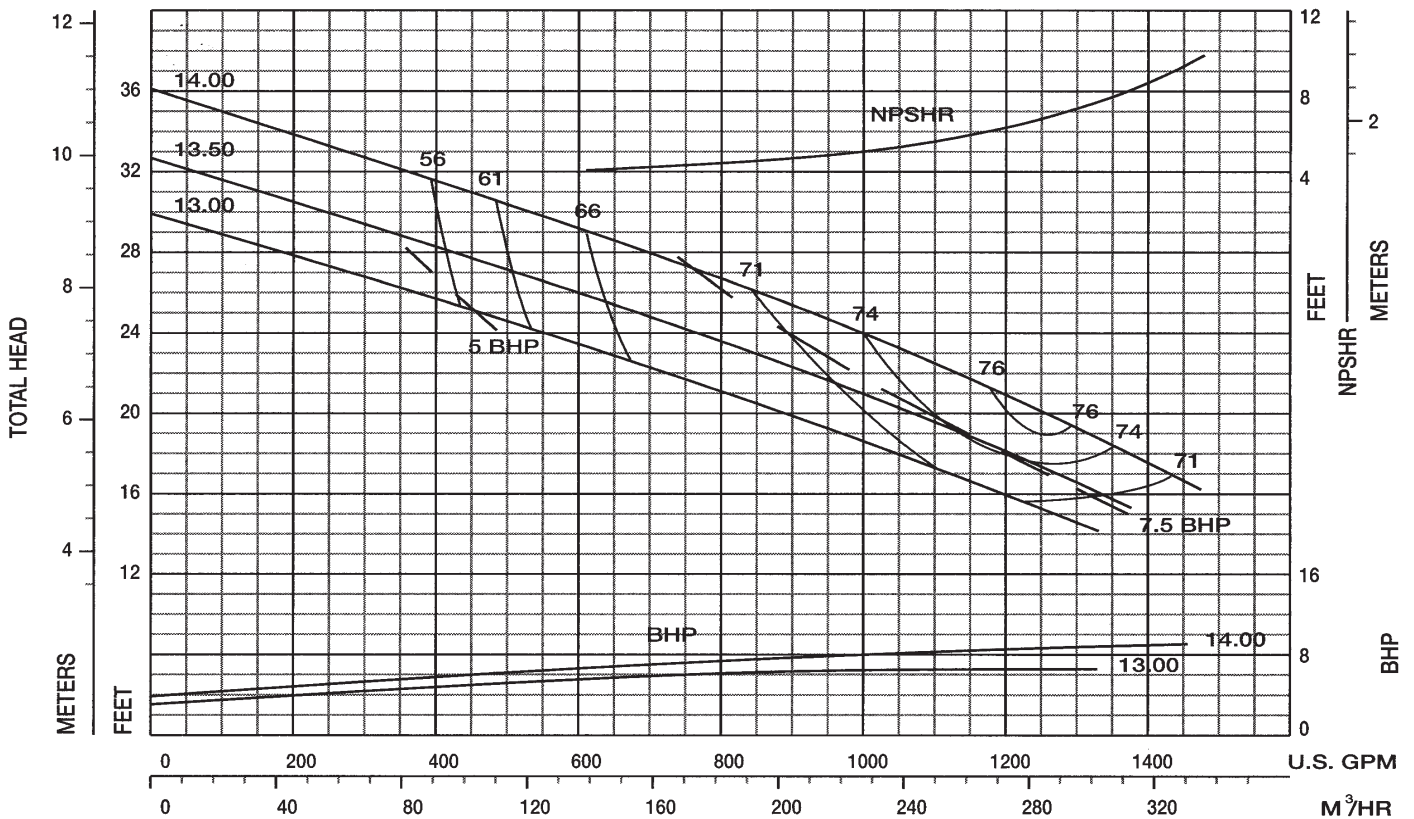

Performance Curve – 6" 5434 MV

RPM: 705 SOLIDS: 3"

IMPELLER: TAJC5BH, 2 VANE SUCTION: 6" INLET: 60.58 in²

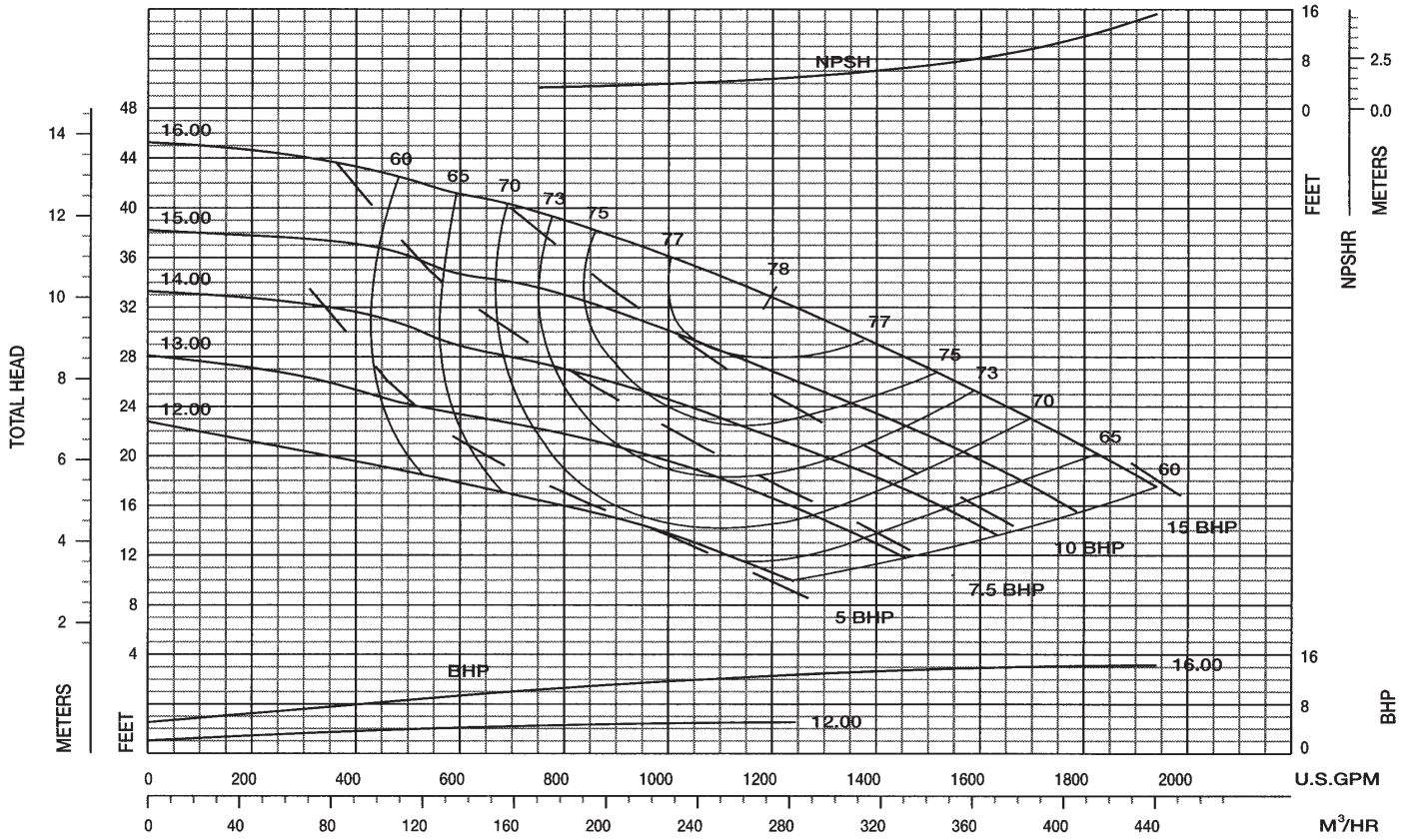

Performance Curve – 6" 5434 MV

RPM: 705 SOLIDS: 4"

IMPELLER: TAJC5DC, 2 VANE SUCTION: 6" INLET: 70.85 in²

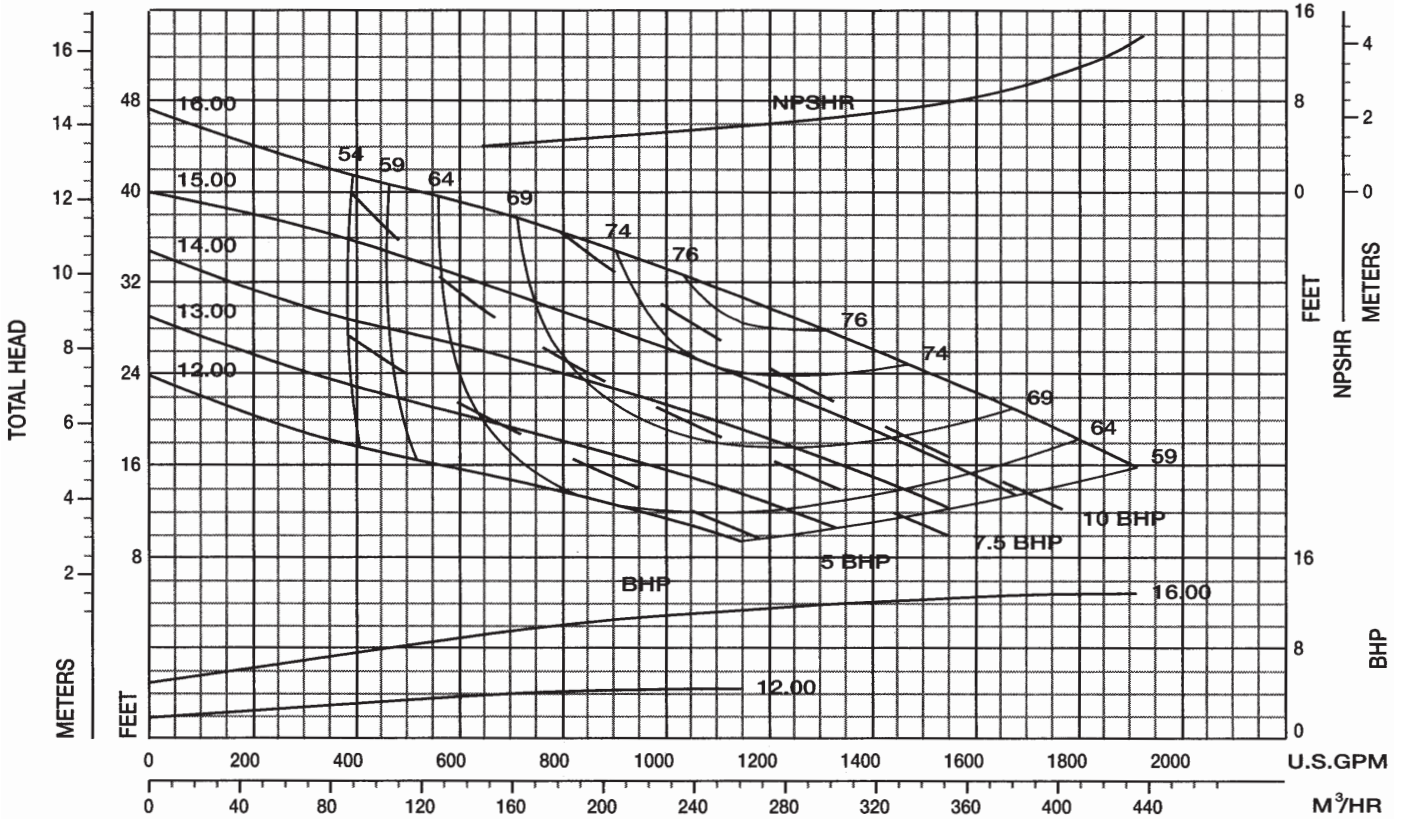

Performance Curve – 6" 5434 MV

RPM: 705 SOLIDS: 3"

IMPELLER: TAJC5BJ, 3 VANE SUCTION: 6" INLET: 64.55 in²

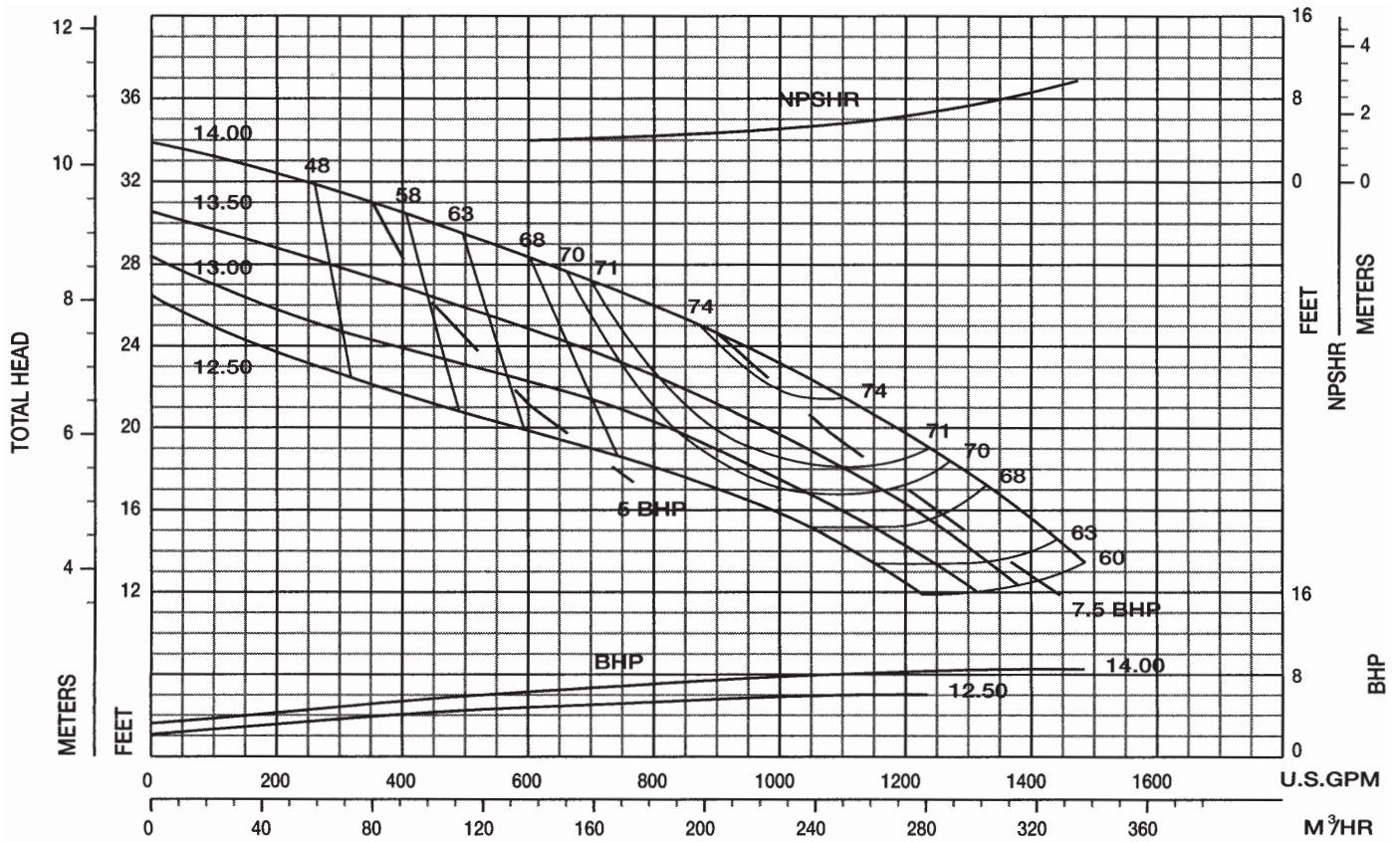

Performance Curve – 8" 5434 MTK, WK, WDK

RPM: 705 SOLIDS: 5"

IMPELLER: T8D1G, BLADELESS SUCTION: 10" (WDK: 8" or 10") INLET: 50.30 in²

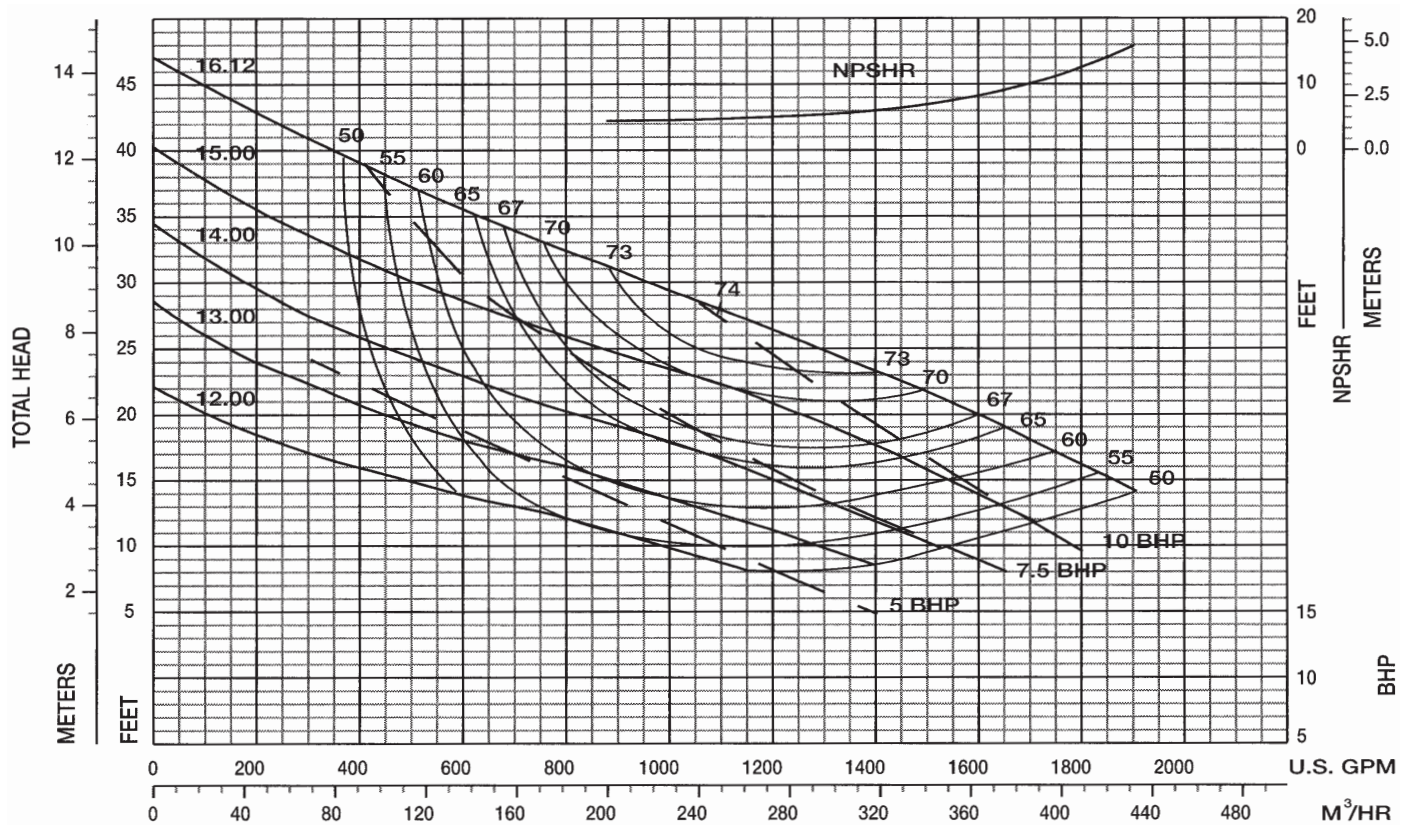

Performance Curve – 8" 5434S MT, W, WD

RPM: 705 SOLIDS: 3-1/2"

IMPELLER: T8D1A, 2 VANE SUCTION: 10" (WD: 8" or 10") INLET: 62.99 in²

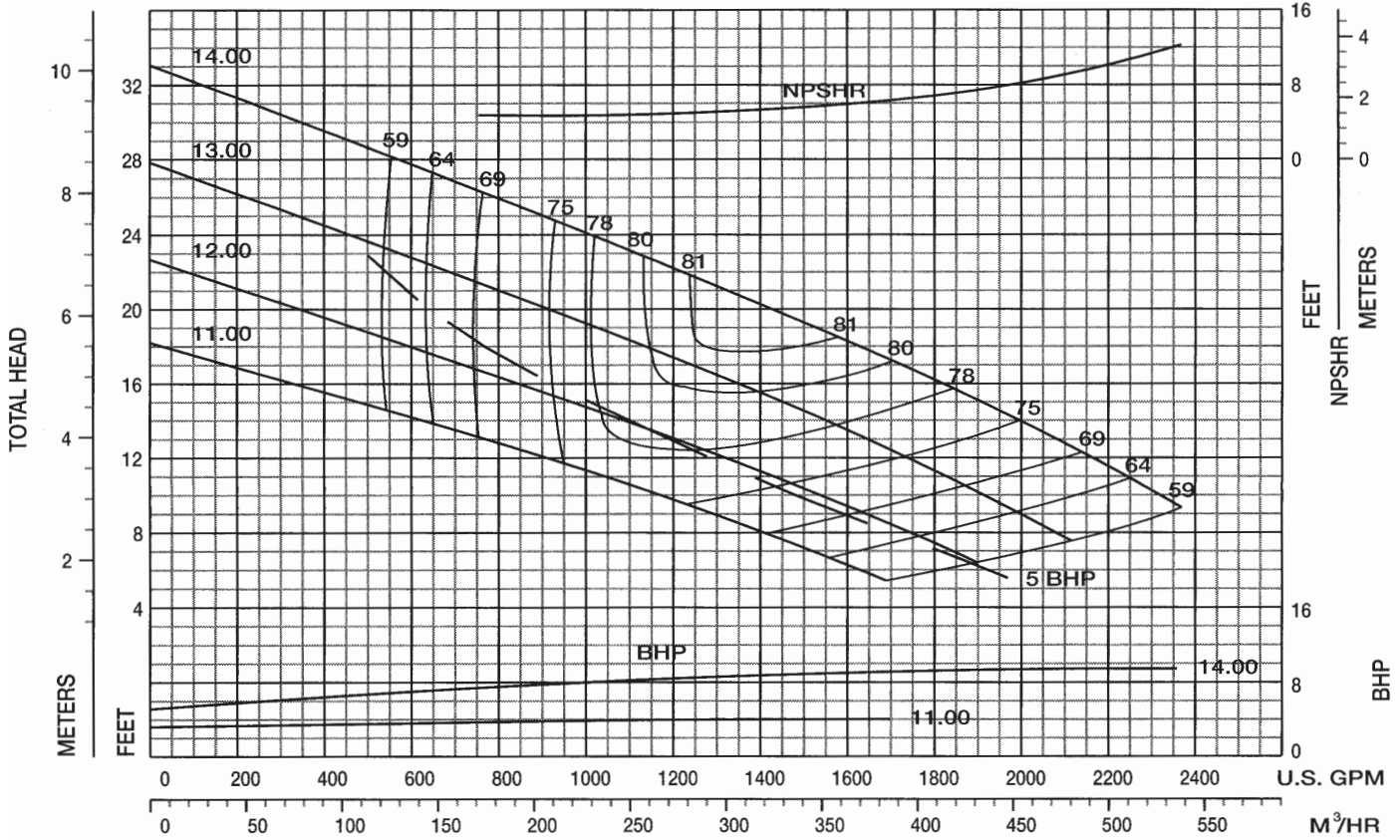

Performance Curve – 8" 5434L MT, W, WD

RPM: 705 SOLIDS: 5"

IMPELLER: TAKC5W, 2 VANE SUCTION: 10" (WD: 8" or 10") INLET: 99.93 in²

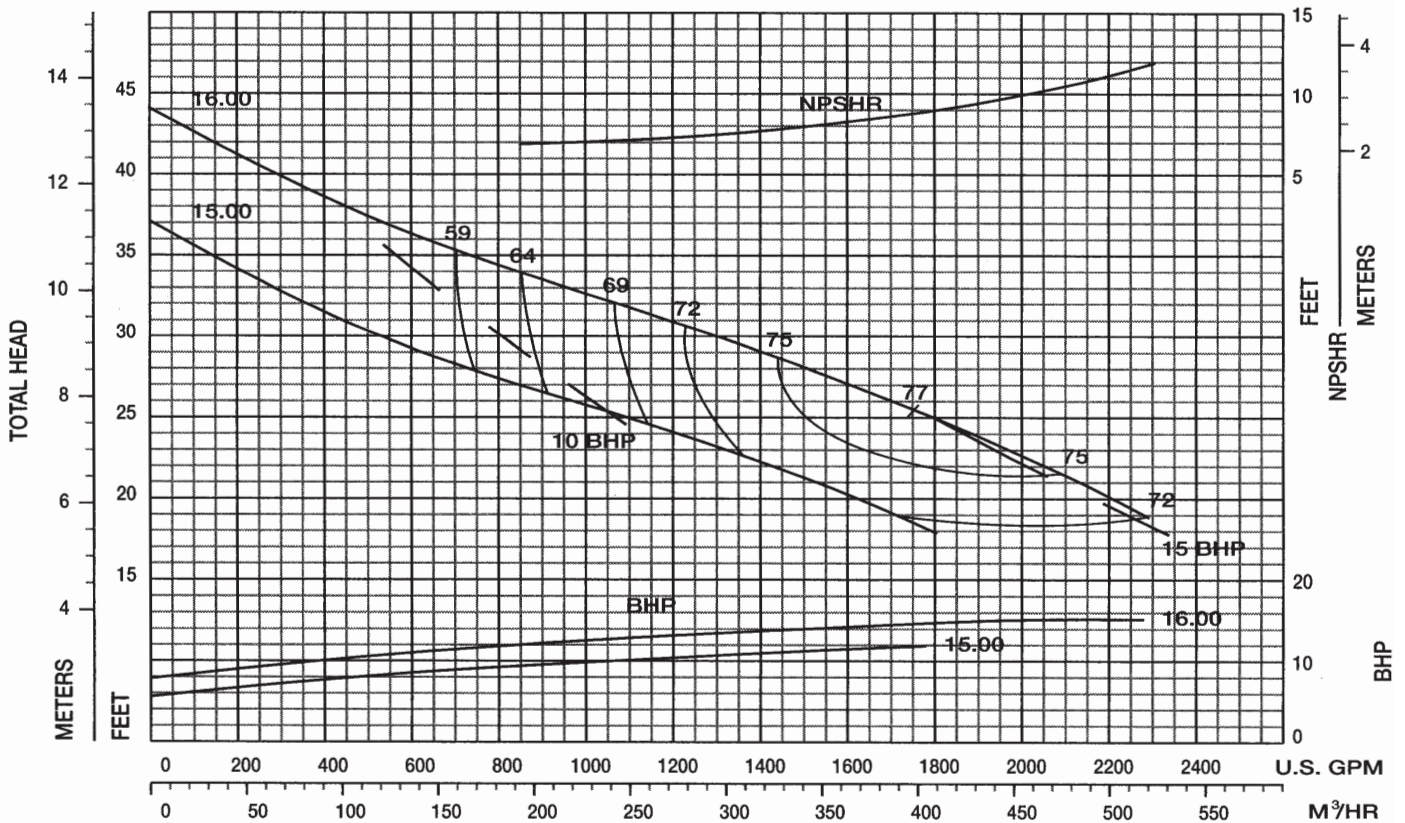

Performance Curve – 8" 5434L MT, W, WD

RPM: 705 SOLIDS: 4"

IMPELLER: T8D1D, 2 VANE SUCTION: 10" (WD: 8" or 10") INLET: 72.94 in²

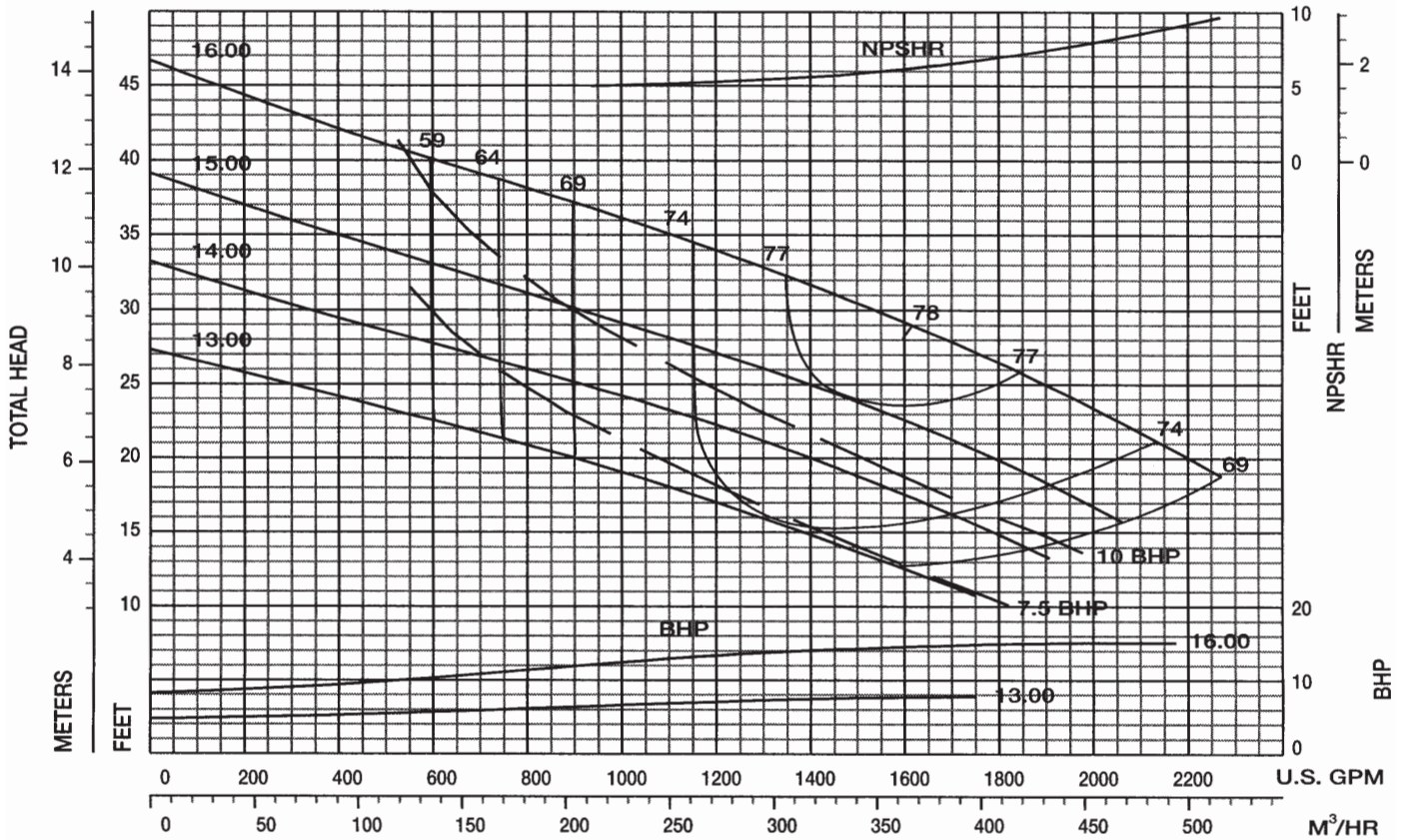

Performance Curve – 8" 5434S MV

RPM: 705 SOLIDS: 3-1/2"

IMPELLER: T8D1A, 2 VANE SUCTION: 10" INLET: 66.99 in²

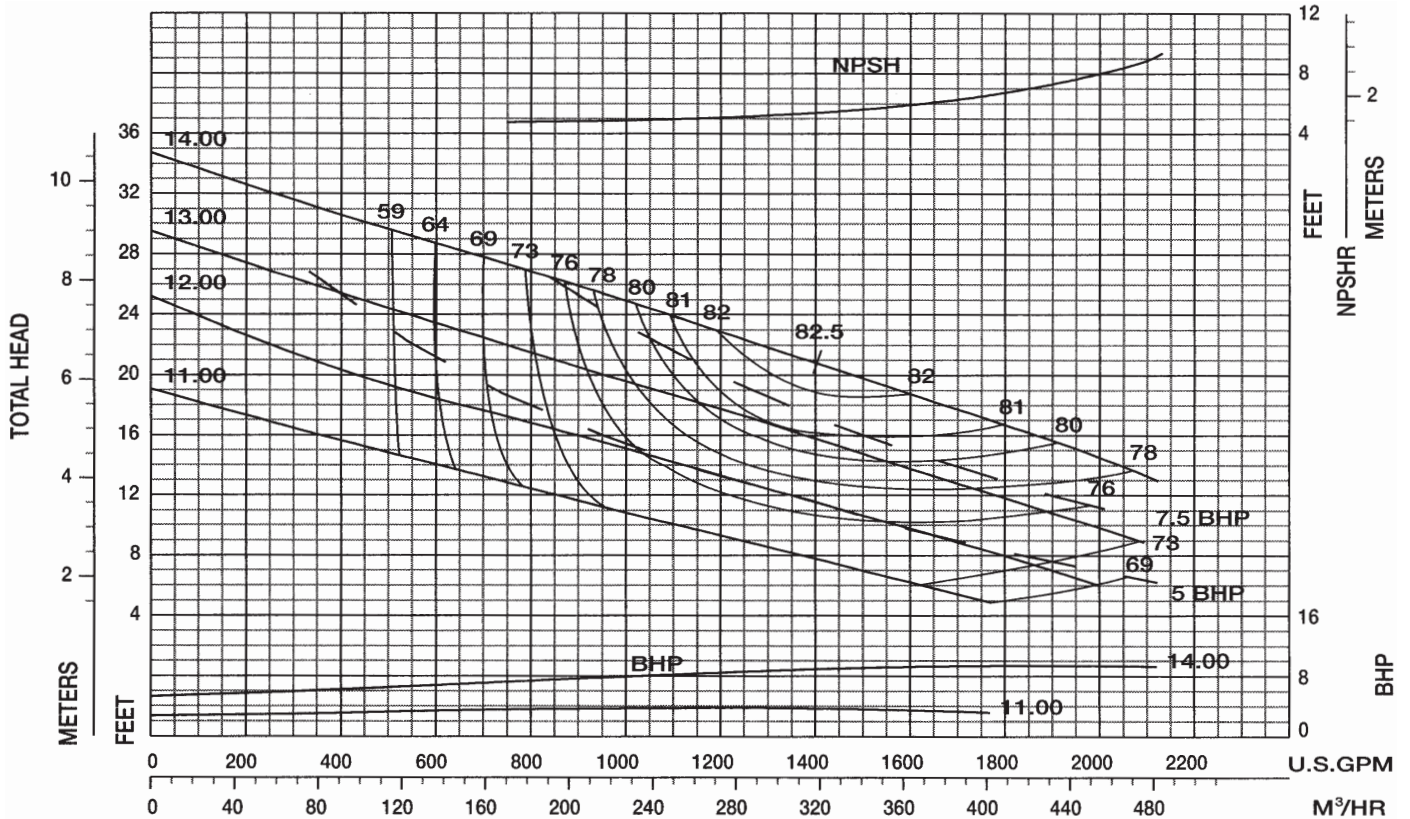

Performance Curve – 8" 5434L MV

RPM: 705 SOLIDS: 5"

IMPELLER: TAKC5W, 2 VANE SUCTION: 10" INLET: 99.93 in²

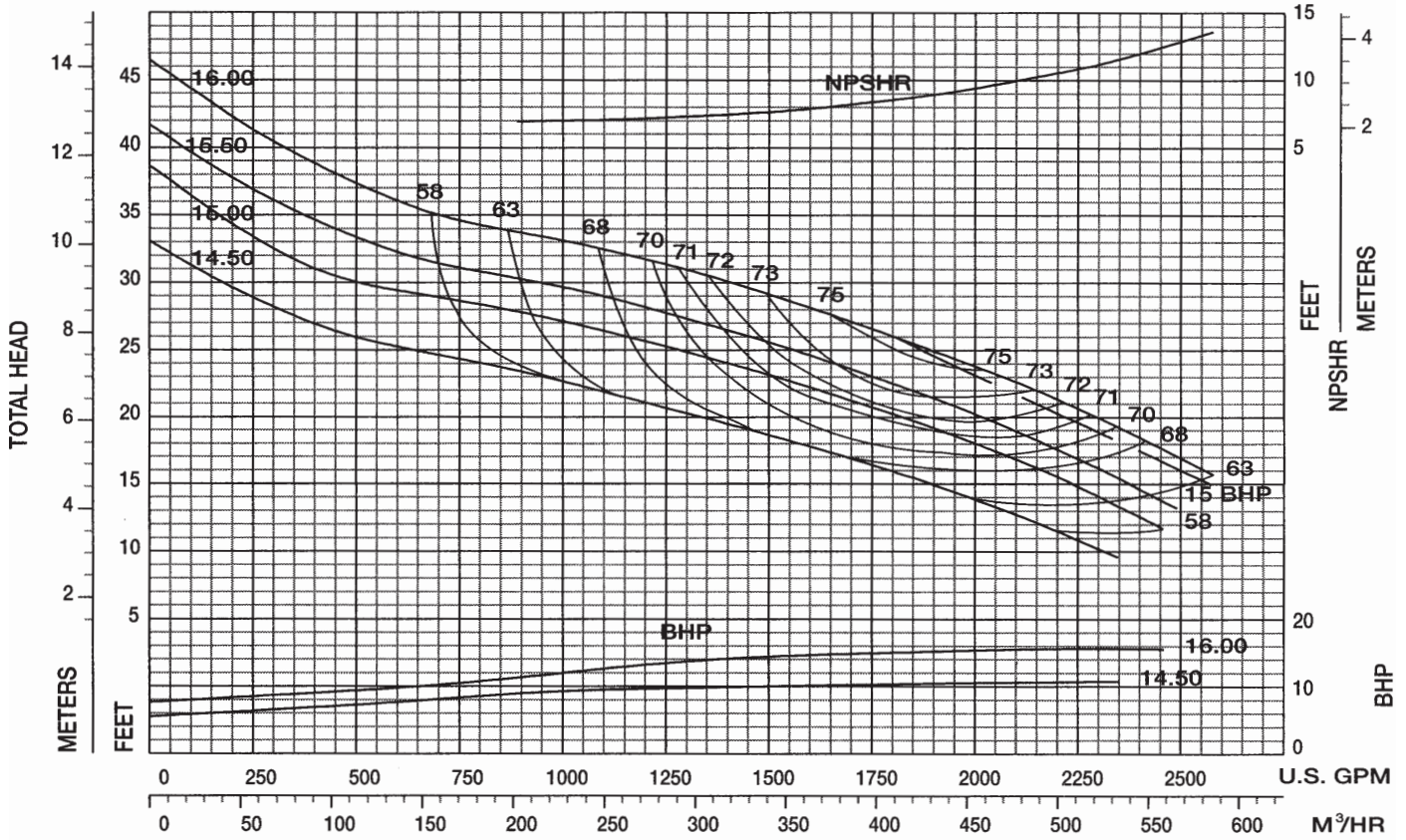

Performance Curve – 8" 5434L MV

RPM: 705 SOLIDS: 4"

IMPELLER: T8D1D, 2 VANE SUCTION: 10" INLET: 72.94 in²

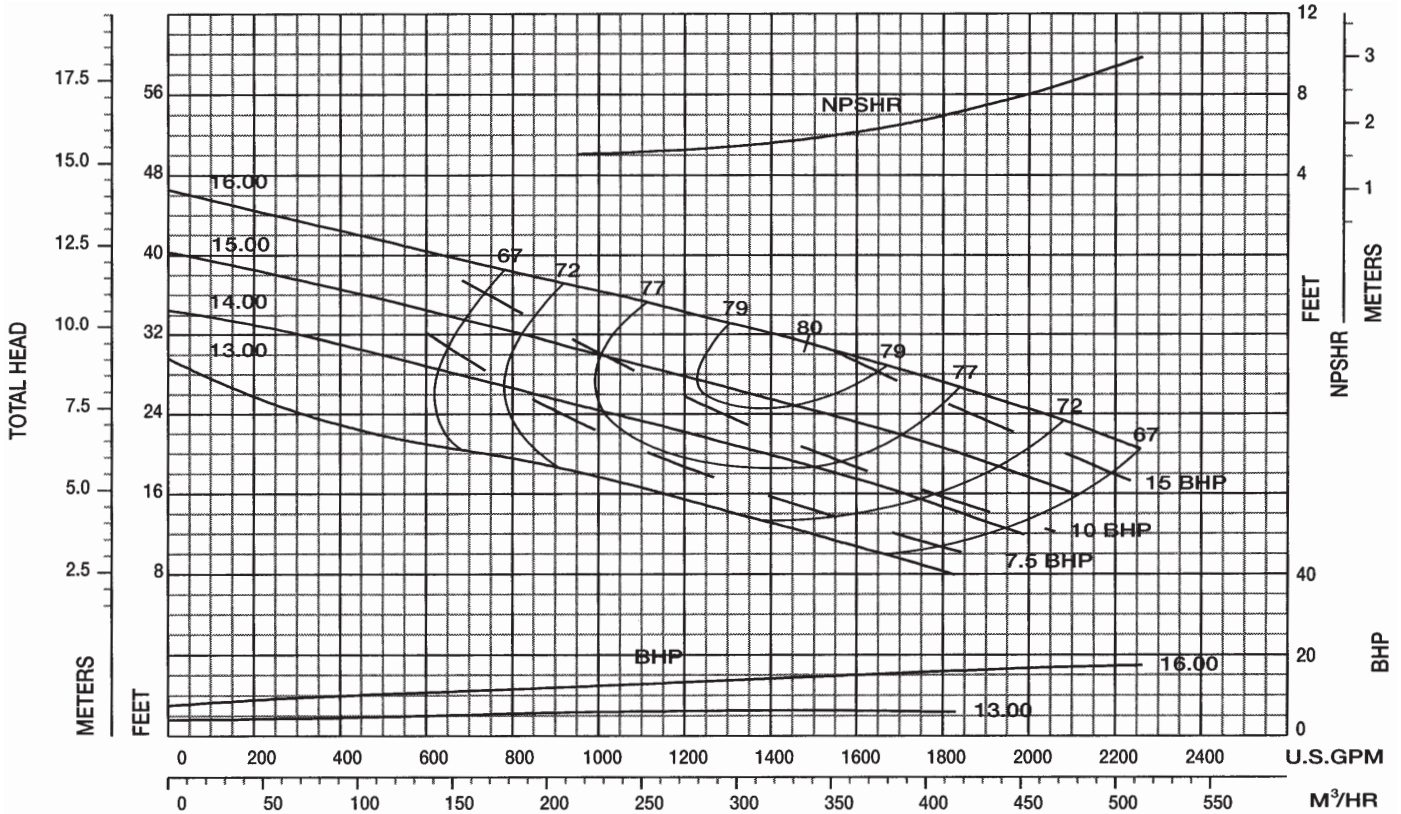

Performance Curve – 8" 5435 MT, W, WD

RPM: 705 SOLIDS: 5"

IMPELLER: TAKE5N, 2 VANE SUCTION: 8" (WD: 8" or 10") INLET: 130.29 in²

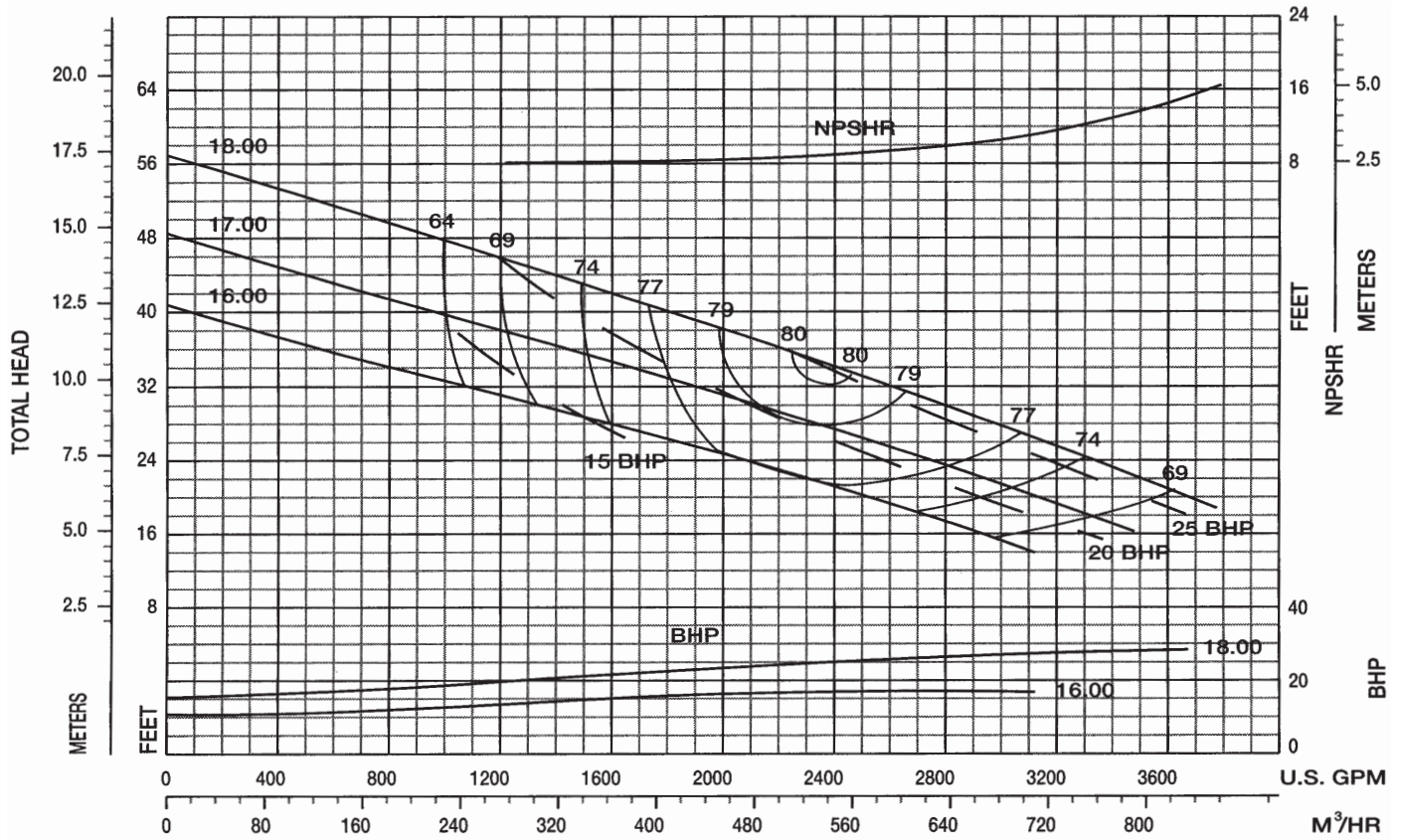

Performance Curve – 8" 5435 MV

RPM: 705 SOLIDS: 5"

IMPELLER: TAKE5N, 2 VANE SUCTION: 8" INLET: 130.29 in²

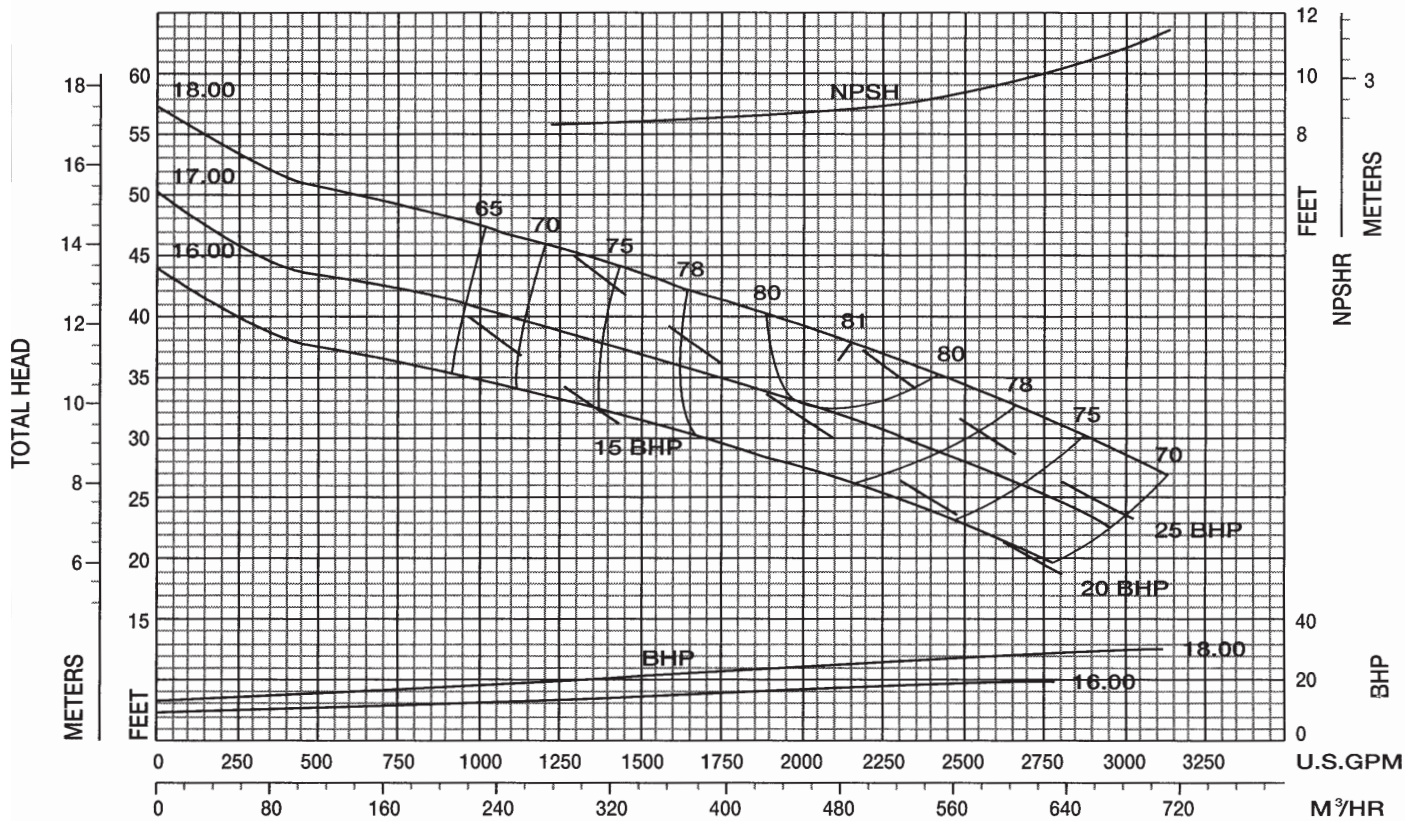

Performance Curve – 8" 5435 MT, W, WD

RPM: **705** SOLIDS: **5"**

IMPELLER: TAKE5U, 2 VANE SUCTION: 8" (WD: 8" or 10") INLET: 108.36 in²

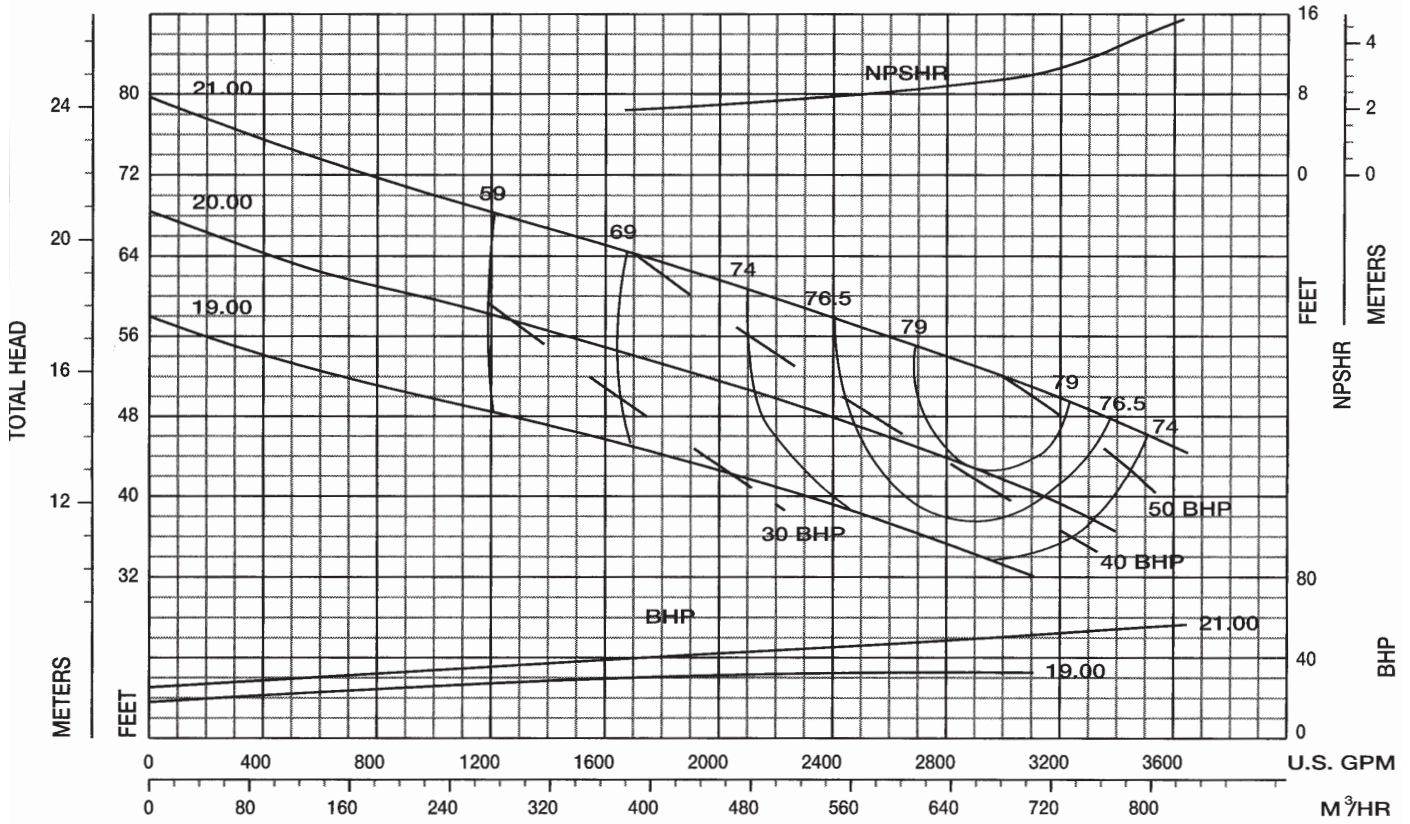

Performance Curve – 8" 5435 MV

RPM: **705** SOLIDS: **5"**

IMPELLER: TAKE5U, 2 VANE SUCTION: 8" INLET: 108.36 in²

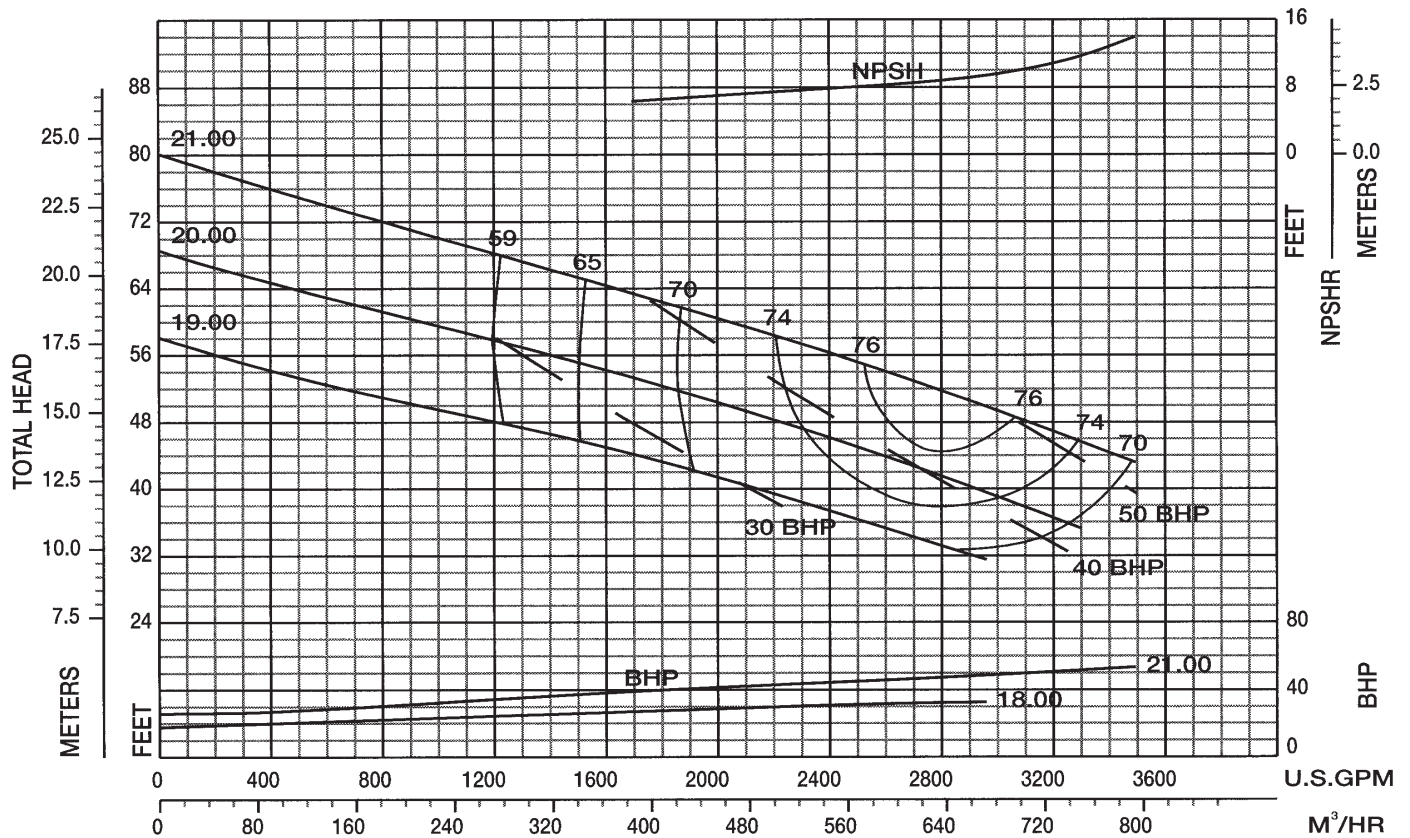

Performance Curve – 10" 5435 MTK, WK, WDK

RPM: 705 SOLIDS: 6"

IMPELLER: TALE5AL, BLADELESS SUCTION: 10" (WDK: 8" or 12") INLET: 63.62 in²

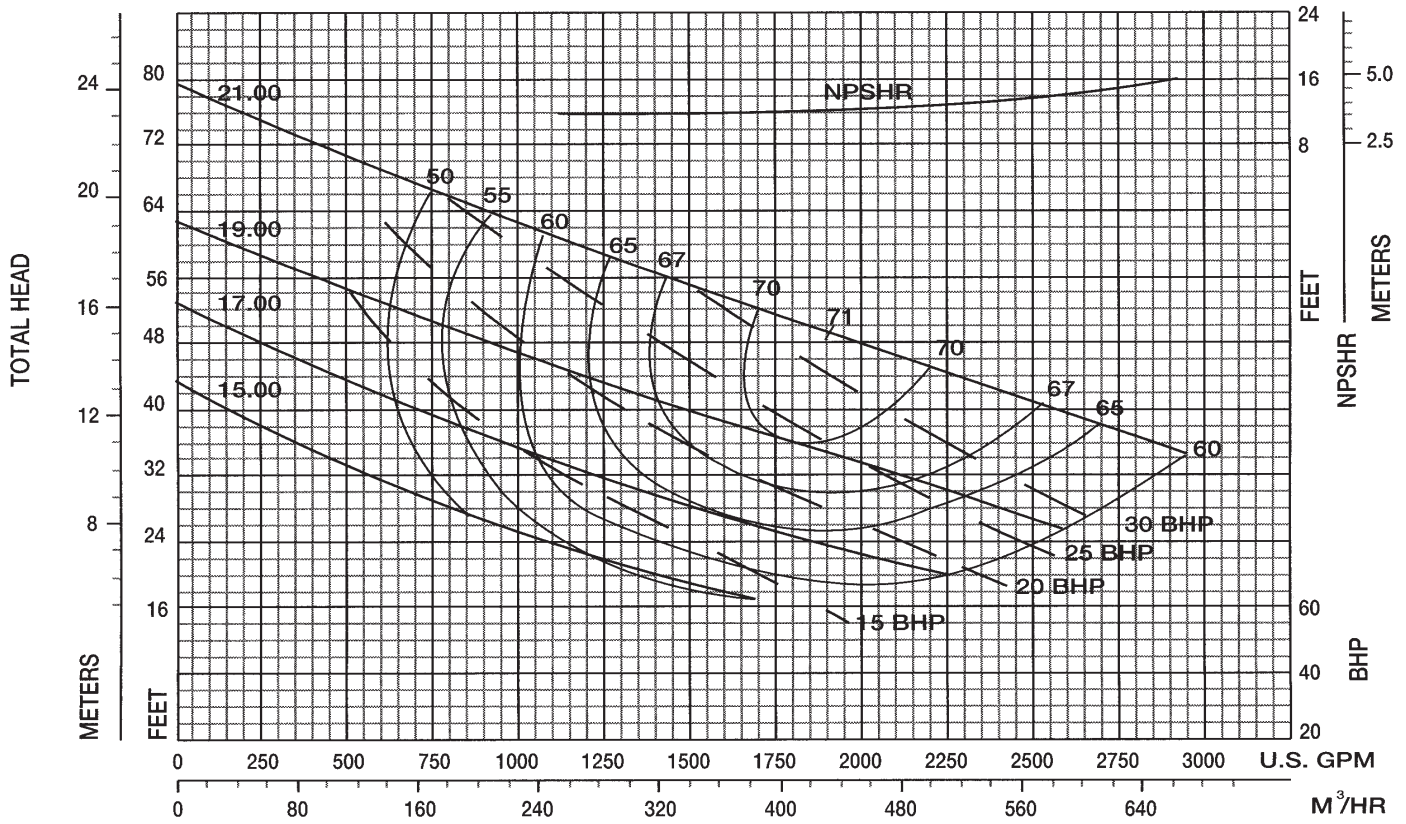

Performance Curve – 10" 5435 MT, W, WD

RPM: 705 SOLIDS: 6"

IMPELLER: TALE5A, 2 VANE SUCTION: 10" (WD: 10" or 12") INLET: 127.43 in²

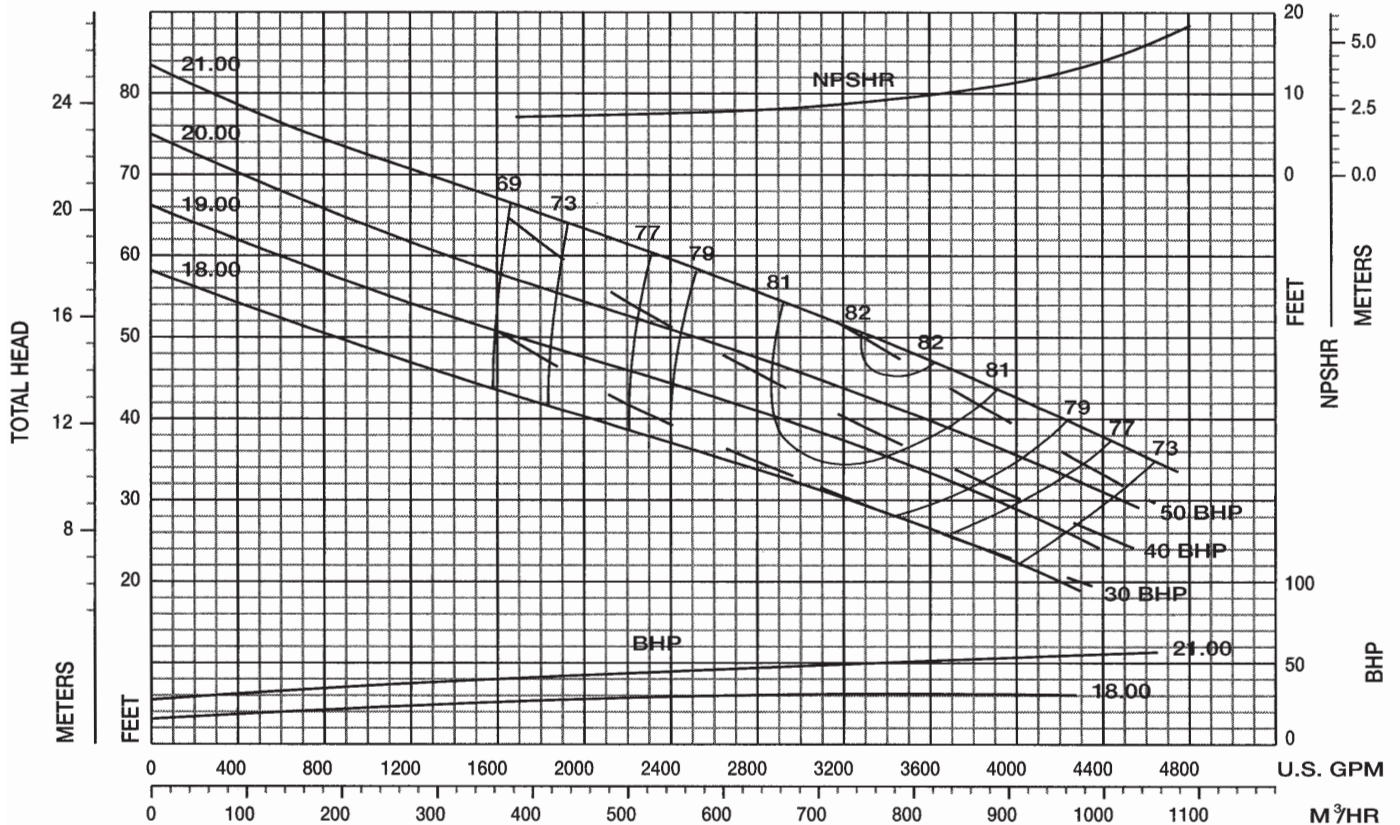

Performance Curve – 10" 5435 MVK

RPM: 705 SOLIDS: 6"

IMPELLER: TALE5AL, BLADELESS SUCTION: 10" INLET: 63.62 in²

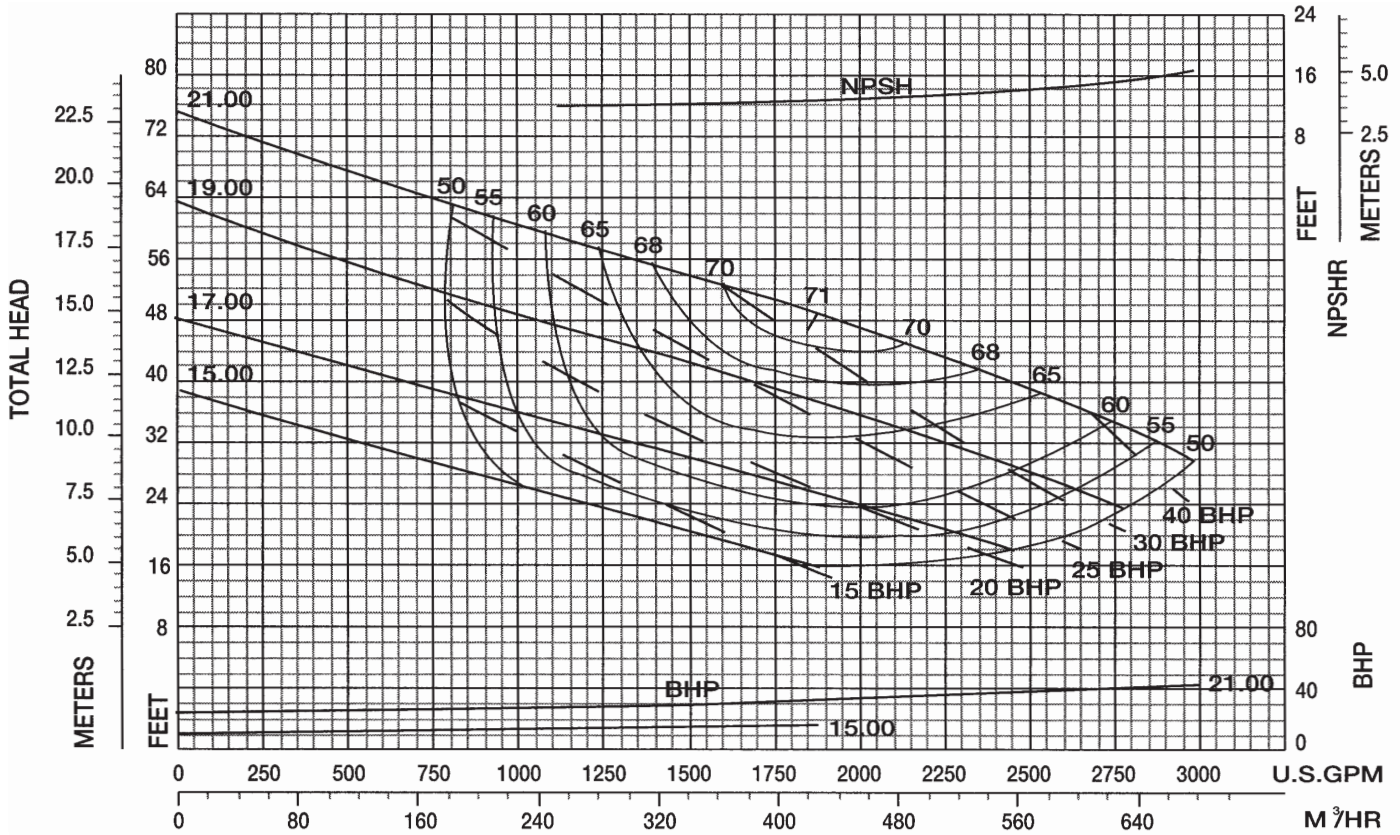

Performance Curve – 10" 5435 MV

RPM: 705 SOLIDS: 6"

IMPELLER: TALE5A, 2 VANE SUCTION: 10" INLET: 127.43 in²

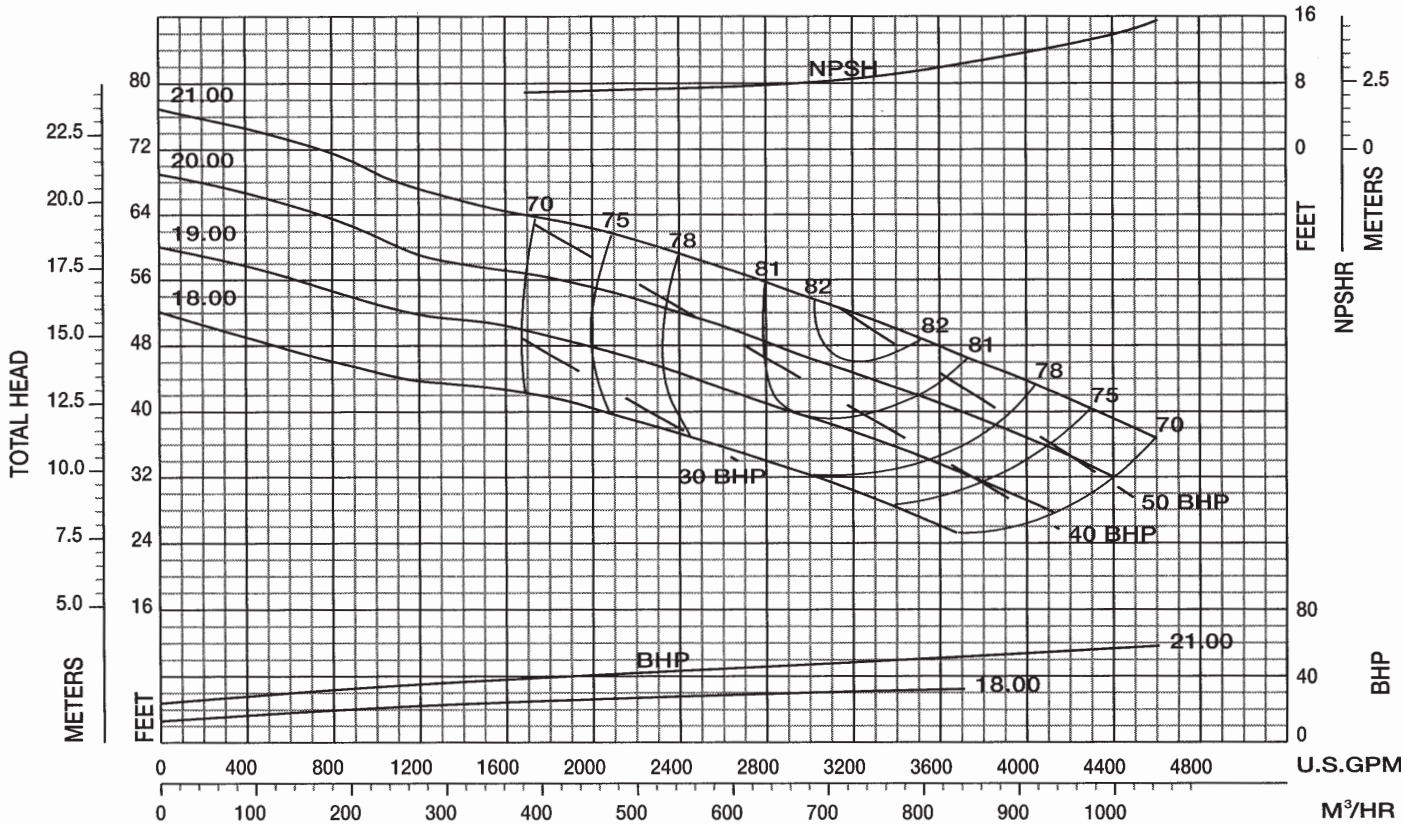

Performance Curve – 8" 5436 MT, W, WD

RPM: 705 SOLIDS: 5"

IMPELLER: TAKE5DF, 2 VANE SUCTION: 10" (WD: 12") INLET: 93.22 in²

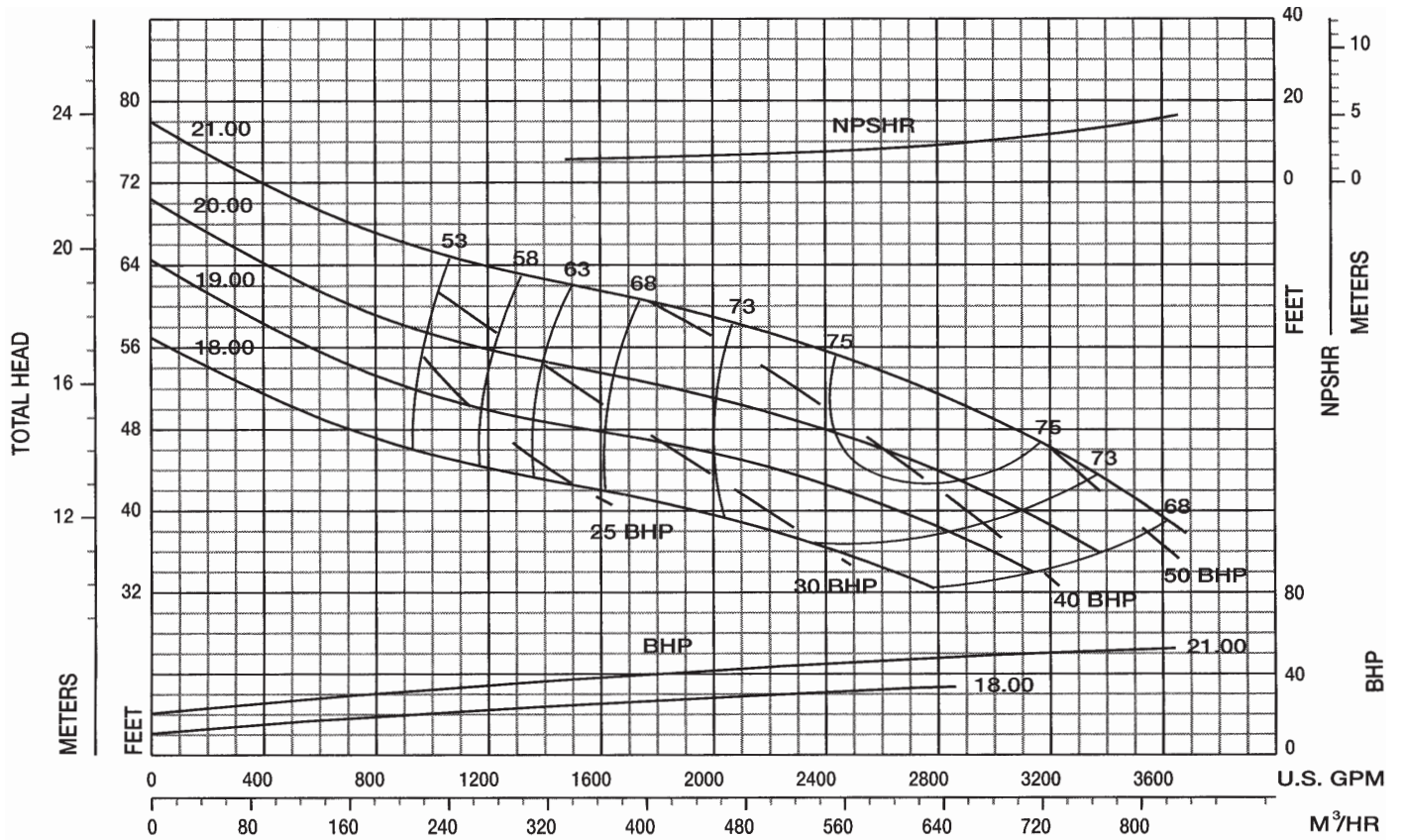

Performance Curve – 8" 5436 MV

RPM: 705 SOLIDS: 5"

IMPELLER: TAKE5DF, 2 VANE SUCTION: 8" INLET: 93.22 in²

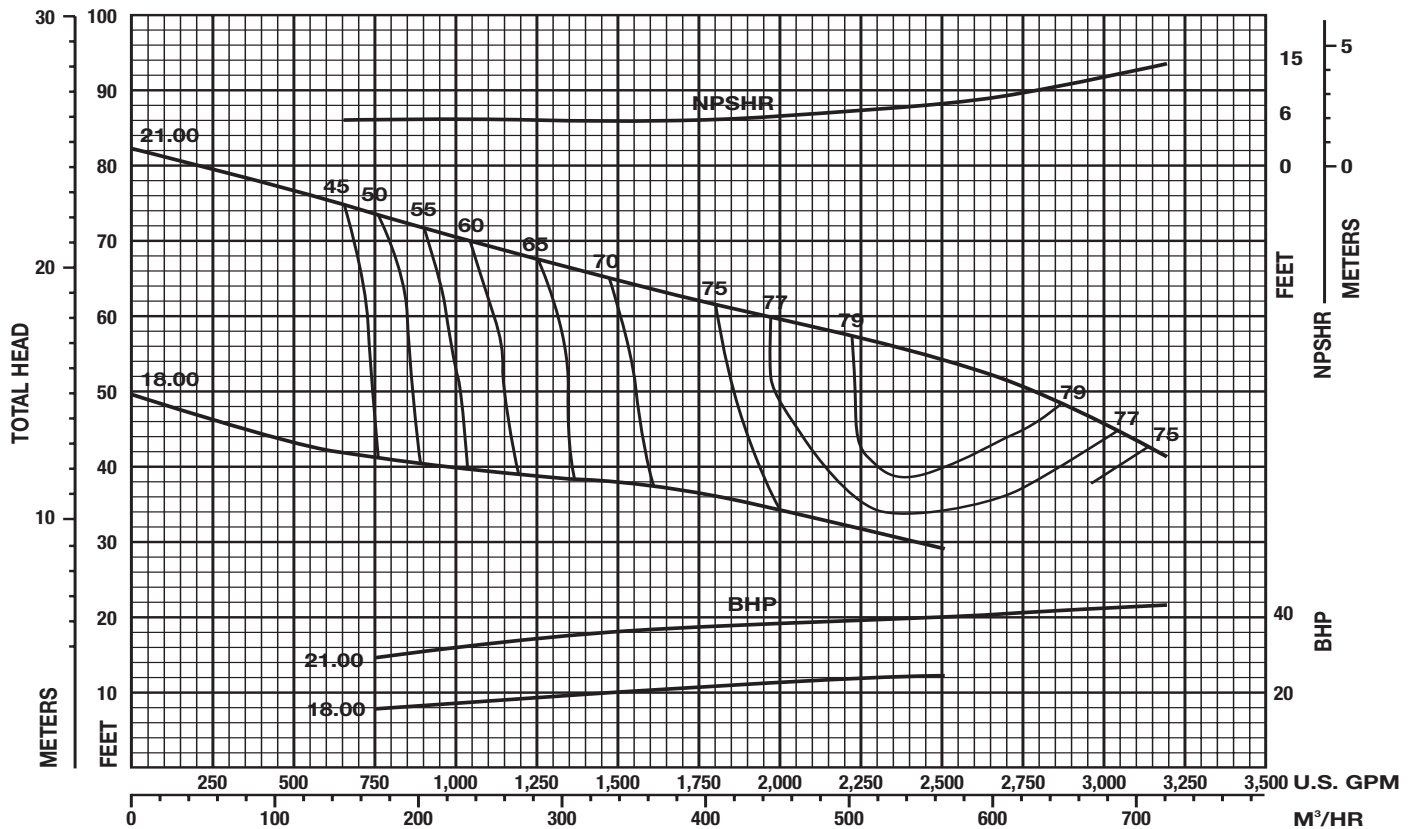

THIS PAGE INTENTIONALLY LEFT BLANK